



**CATALOGUE**  
MAY 2024

**KROMO**  
YOUR SMART WASH



**KROMO**  
YOUR SMART WASH



## UNDER-COUNTER DISHWASHERS

BLUE	Robust and essential glass & dishwashers	2
AQUA	Glass & dishwashers with double-wall door	10
DUPLA	Double skin glass & dishwashers	18
LUX	High-tech double skin glass & dishwashers	26
PREMIUM	Connected glass and dishwashers with clean water technology	36

## HOOD-TYPE DISHWASHERS

HOOD 70	Robust and essential hood-type dishwashers	46
HOOD 80 - 110	Single skin hood-type dishwashers	54
HOOD 110 I	Insulated hood-type dishwashers	62
HOOD 130 LUX	Latest generation hood-type dishwashers	70
HOOD 140 PREMIUM	Connected hood-type dishwashers with clean water technology	80



## STOCK & WASH DISHWASHERS

WASH & STORE	Stock & Wash dishwashers	90
--------------	--------------------------	----

## RACK-TYPE DISHWASHERS

RK COMPACT	Compact rack-type dishwashers with simple rinse	98
RK UP	Rack-type dishwashers with single or double rinse	106
RK LUX	Rack-type dishwashers with reinforced double rinse	122
RK PREMIUM	Rack-type dishwashers with 3R+ reinforced triple rinse	134

## FLIGHT-TYPE DISHWASHERS

 QK LUX	Flight-type dishwashers with reinforced double rinse	146
 QK PREMIUM	Flight-type dishwashers with 3R+ reinforced triple rinse	162

## TUNNEL TRAY WASHER & TRANSPORTATION SYSTEMS

TK	Tunnel traywasher with dryer	178
TL	Transportation systems	182

## WAREWASHERS

POT	Warewashers	184
-----	-------------	-----

## GRANULE WAREWASHER

GRANULE	Granule warewashers	196
---------	---------------------	-----

## PULL-THROUGH CRATE WASHERS

VK - VK LUX	Pull-through crate washers	202
-------------	----------------------------	-----

## CONVEYOR CRATE WASHERS

LK - LK-HD	Conveyor crate washers	212
------------	------------------------	-----

<b>BASKETS</b>	Standard supplied baskets	224
----------------	---------------------------	-----

<b>SALES CONDITIONS</b>	General sales conditions	201
-------------------------	--------------------------	-----

# BLUE

ROBUST AND ESSENTIAL  
GLASS & DISHWASHERS

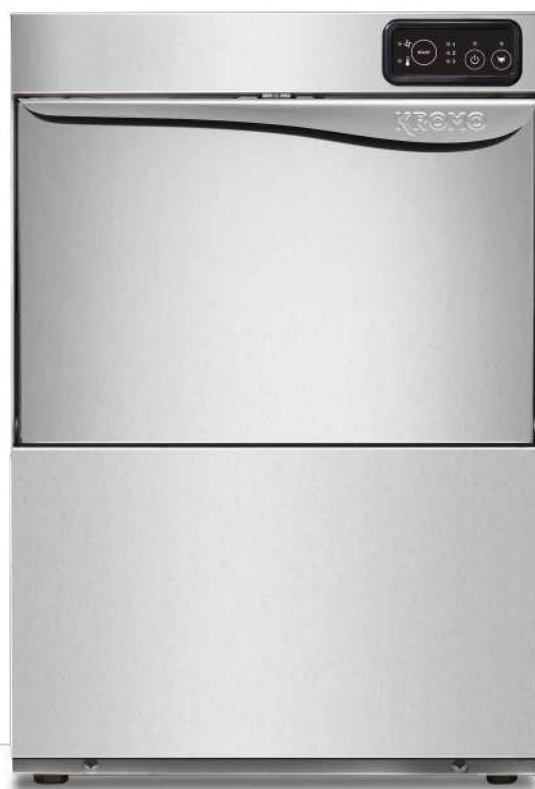
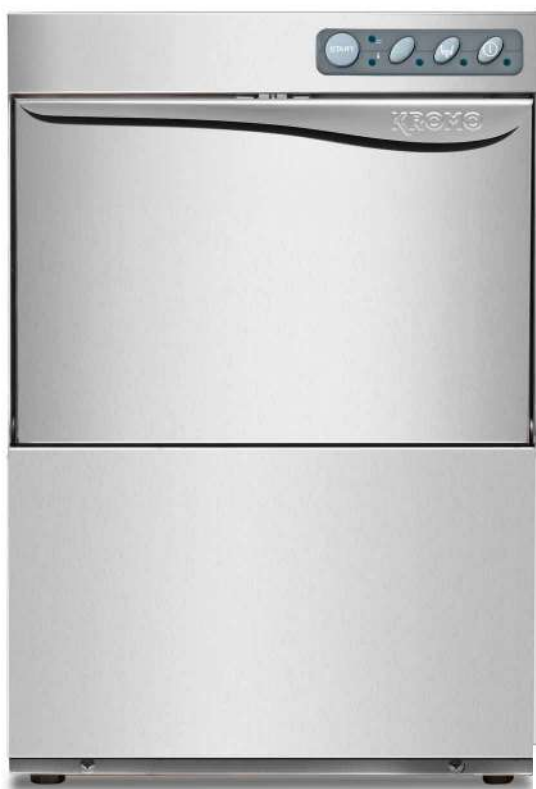

You asked and we listened! We are thrilled to announce our brand new range: BLUE. These robust and essential glass and dishwashers simply make sense. Nothing superfluous: solid S/S body

with double wall-door, sloped tank, innovative and light arms, controlled temperatures and, only if needed, detergent dispenser and drain pump. Wash, rinse, restart. It is really that simple.











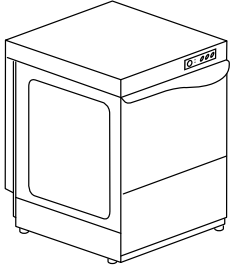

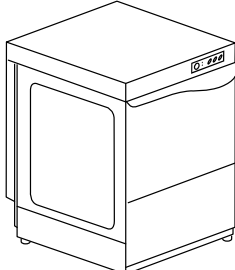

## ELECTRONIC VERSION



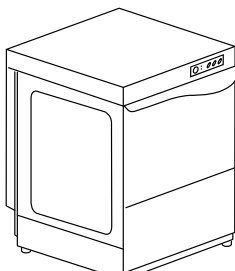







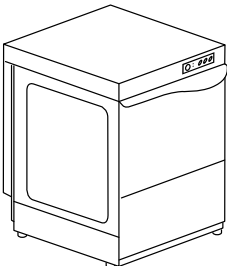

The intuitive LED control panel of the BLUE L models will display if the correct temperatures of both tank and boiler have been reached. You can choose among 3 different wash programs to perfectly tailor the performances of the machine to the crockery that needs to be cleaned.

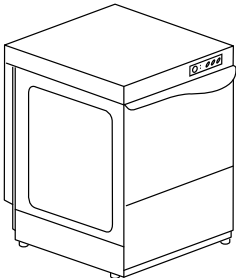
## FEATURES

- Solid structure in AISI 304 stainless steel
- Sound and heat proof double-skin door
- Door with anti-shock system
- Sloped tank with screwed basket rails
- Overflow and drain pipes integrated system, for a triple protection of the washing pump
- Non-drip roof to safeguard the hygiene of the freshly washed dishes
- 1 wash cycle on electromechanical versions
- 3 wash cycles on electronic versions
- Innovative system of coupled wash and rinse arms in polypropylene and fiber of glass (BLUE 50 / BLUE 50 L)
- Light wash and rinse arms, granting the best efficiency also when the water pressure is weaker
- Easy to remove nozzles, to help with daily cleaning operations
- Back flow prevention valve
- Thermostop system: the rinse starts only when the water in boiler reaches 85 °C
- Standard rinse-aid dispenser
- Glasswashers also available with round basket (BLUE 35 / BLUE 40)
- Self-cleaning cycle on the electronic versions

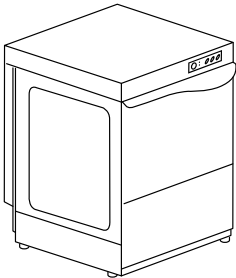
Model		Voltage	Capacity	Dimensions	Code
<b>BLUE 35</b> 1 PROGRAM					
	<p><b>new</b></p> <p>RACK EQUIPMENT</p> <p>2 X 10730 1 X 10728 1 X 15060</p> 	230 V ~ 50 Hz 2,59 kW	 195 H  350x350	400x495x585 H 28 kg	<b>BLUE 35</b>
<b>BLUE 40</b> 1 PROGRAM					
	<p><b>new</b></p> <p>RACK EQUIPMENT</p> <p>2 X C121 1 X 10728 1 X 15060</p> 	230 V ~ 50 Hz 2,59 kW 2,65 kW (LS)	 305 H  Ø 295 (LS)  400x400	450x535x700 H 37 kg	<b>BLUE 40</b>  <b>BLUE 40 LS</b>
<b>BLUE 50</b> 1 PROGRAM					
	<p><b>new</b></p> <p>RACK EQUIPMENT</p> <p>2 X C40 1 X C44 1 X 15060</p> 	230 V ~ 50 Hz 3,2 kW	 320 H  Ø 345  500x500	590x600x850 H 57 kg	<b>BLUE 50</b>



Model		Voltage	Capacity	Dimensions	Code
<b>BLUE 35 L</b> 3 PROGRAMS					
	<p><b>NEW</b></p> <p>RACK EQUIPMENT</p> <p>2 X 10730 1 X 10728 1 X 15060</p> 	230 V ~ 50 Hz 2,59 kW	 195 H   350x350	400x495x585 H 28 kg	<b>BLUE 35 L</b>
<b>BLUE 40 L</b> 3 PROGRAMS					
	<p><b>NEW</b></p> <p>RACK EQUIPMENT</p> <p>2 X C121 1 X 10728 1 X 15060</p> 	230 V ~ 50 Hz 2,59 kW 2,65 kW (LS)	 305 H   Ø 295 (LS)   400x400	450x535x700 H 37 kg	<b>BLUE 40 L</b>  <b>BLUE 40 LS L</b>
<b>BLUE 50 L</b> 3 PROGRAMS					
	<p><b>NEW</b></p> <p>RACK EQUIPMENT</p> <p>2 X C40 1 X C44 1 X 15060</p> 	230 V ~ 50 Hz 3,2 kW	 320 H   Ø 345   500x500	590x600x850 H 57 kg	<b>BLUE 50 L</b>

## OPTIONS

Model	220-240 V 50 Hz	Drain Pump	Detergent Dispenser	Rinse-Aid Dispenser	Round Basket	thermostop System
<b>BLUE 35</b>	●	€	€	●	€	●
<b>BLUE 40</b>	●	€	€	●	€	●
<b>BLUE 40 LS</b>	●	€	€	●	€	●
<b>BLUE 50</b>	●	€	€	●	----	●
<b>BLUE 35 L</b>	●	€	€	●	€	●
<b>BLUE 40 L</b>	●	€	€	●	€	●
<b>BLUE 40 LS L</b>	●	€	€	●	€	●
<b>BLUE 50 L</b>	●	€	€	●	----	●

**LS** Upper wash

**L** LED electronic





● Standard



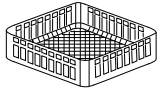

---- Not available

Water supply 55 °C

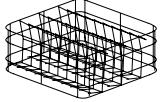
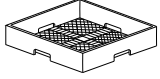
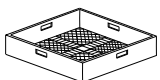
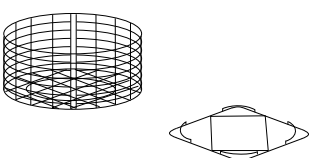
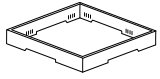
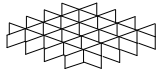
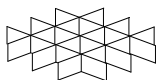
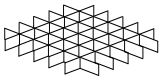
EAC label upon request

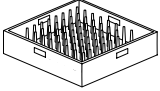
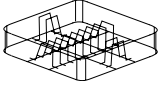
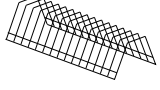

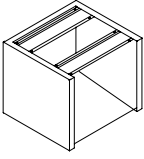
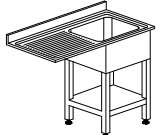
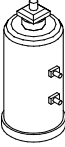
	Description	Capacity	Dimensions	Code
	GLASS BASKET		350x350x110 H	<b>10730</b>
			400x400x135 H	<b>C 121</b>
	SLOPED GLASS BASKET	Ø 100 max	500x500x200 H	<b>C 26</b>
	REUSABLE CUP BASKET	5x5 Glass 30 < Ø < 90 mm H max 185 mm	500x500x235 H	<b>C 135</b> 
	SLOPED GLASS BASKET		Ø 90 max	400x400x185 H <b>C 123</b>
			Ø 120 max	400x400x160 H <b>C 79</b>
	NARROW MESH CUTLERY BASKET		500x500x106 H	<b>C 41</b>
	LARGE MESH BASKET	For glasses	500x500x105 H	<b>C 44</b>
	ROUND GLASS BASKET	Basket	Ø 350x105 H	<b>C 21</b>
		Support	350x350	<b>C 36</b>
	ROUND BASKET SUPPORT	Basket	Ø 400x145 H	<b>C 16</b>
		Support	400x400	<b>C 38</b>
	HOLDER FOR GLASS SUPPORT	For glass support (C112-C113-C114)	500x500x50 H	<b>C 111</b>
	GLASS SUPPORT	5x5 Glass Ø 87 mm (C111)	500x500x50 H	<b>C 112</b>
	GLASS SUPPORT	4x4 Glass Ø 110 mm (C111)	500x500x50 H	<b>C 113</b>
	GLASS SUPPORT	6x6 Glass Ø 72 mm (C111)	500x500x50 H	<b>C 114</b>

	Description	Capacity	Dimensions	Code	
	PLATE BASKET	18 plates	500x500x105 H	<b>C 40</b>	
	PLATE BASKET	12 plates	400x400x120 H	<b>C 31</b>	
	SAUCER HOLDER	14 saucers	300x100x90 H	<b>10728</b>	
	CUTLERY BASKET		Ø 120x120 H	<b>15060</b>	
	SUPPORT	Stainless steel stand	592x535x500 H	<b>999900517</b>	
	SINK UNIT FOR UNDER-COUNTER MODELS	Sink 500x400x300H	1200x700x850 H	<b>K 5/20*</b>	
	WATER SOFTENER	12 l	Ø 200x500 H	<b>DEP 12</b>	
	AUTOMATIC WATER SOFTENER	12 l (max 800 l)	315x510x685 H	<b>DEP 12-AUT</b>	

\* Wooden cage +2% minimum €  
Special dimensions for tables upon request  
Tables shown in right-to-left version

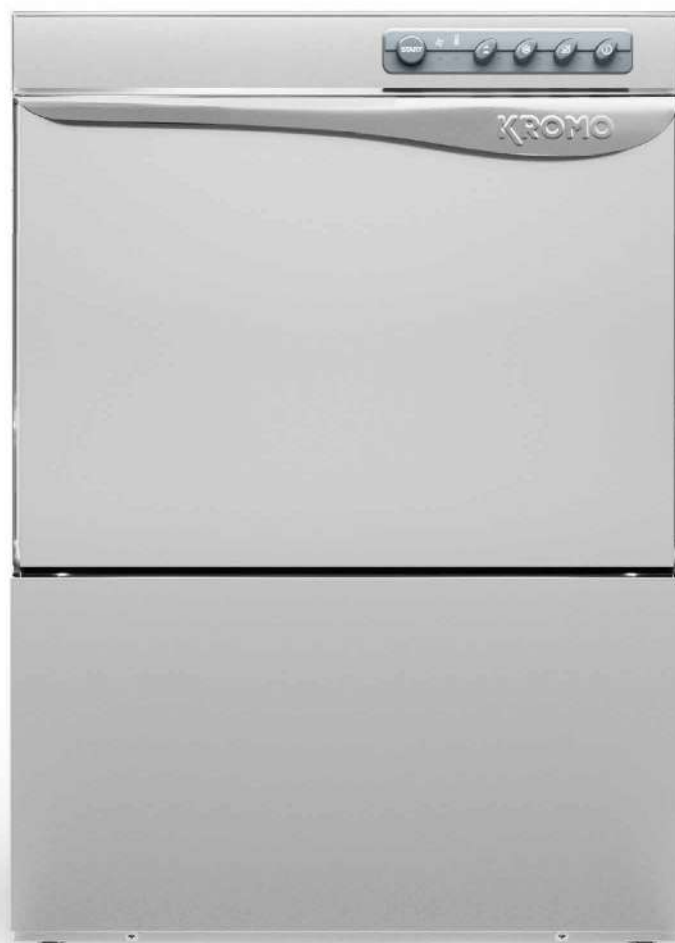

The glass and dishwashers of the AQUA series are ideal for bars, pubs, restaurants and hotels. These undercounter machines, with a redesigned control panel, feature a wide loading capacity granting the highest performance at a reasonable price.

According to the user's needs the machine can be customized thanks to many optional features such as water softener, detergent dispenser and drain pump.











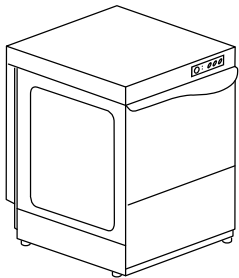

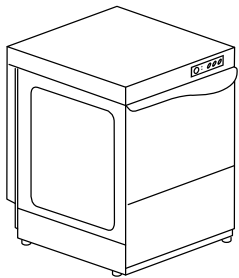



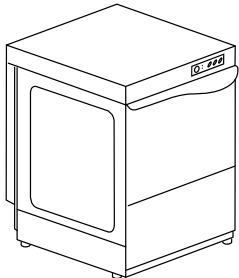

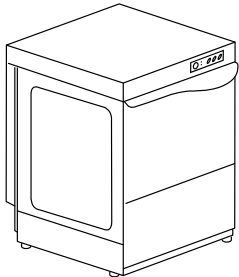

## ELECTRONIC VERSION



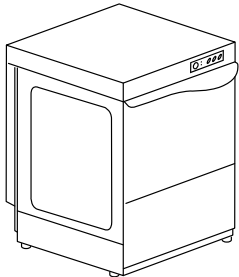







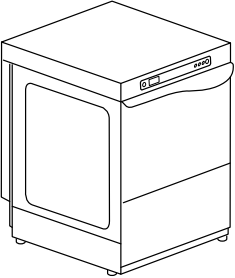

An electronic control panel is available for AQUA T models. The LED panel displays the temperatures of both tank and boiler, the wash cycle and status and main alarm codes for malfunctions. You can now choose among four different washing programs to perfectly tailor the performances of the machine to the crockery that needs to be cleaned. The soft start function grants extra protection for fragile objects.

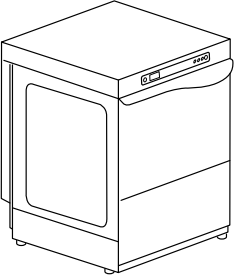
## FEATURES

- AISI 304 structure
- Sound and heat proof double-skin door
- Door with anti-shock system
- Deep-drawn and inclined tank for a perfect total drain
- Overflow and drain pipes integrated system, for a triple protection of the wash pump
- Non-drip roof to safeguard the hygiene of the freshly washed dishes
- Light wash and rinse arms, granting the best efficiency also when the water pressure is weaker
- Easy to remove nozzles, to help with daily cleaning operations
- Back flow prevention valve
- Standard rinse-aid dispenser (peristaltic version on demand)
- Thermostop system: the rinse starts only when the water in boiler reaches 85 °C
- CE certified components
- Electronic version with four preset washing programs
- Automatic regeneration for Touch models with inbuilt water softener
- Glasswashers available also with round basket (AQUA 35 / AQUA 37 / AQUA 40)
- Innovative system of coupled wash and rinse arms in polypropylene and fiber of glass ( AQUA 50 MONO / AQUA 50 T / AQUA 80 T)
- Self-cleaning cycle on the TOUCH versions
- Soft Start wash pump on the TOUCH versions
- Additional upper surface filter (on demand only for AQUA 50 MONO / AQUA 50 / AQUA 50 T / AQUA 80 T)

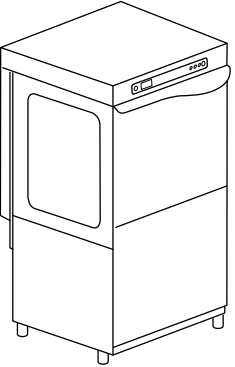
Model	Voltage	Capacity	Dimensions	Code
<b>AQUA 35</b> 1 PROGRAM				
 <p><b>RACK EQUIPMENT</b></p> <p>2 X 10730 1 X 10728 1 X 15060</p>	230 V ~ 50 Hz 2,6 kW	 195 H  350x350	400x495x585 H 28 kg	<b>AQUA 35</b>  <b>AQUA 35 D</b>
<b>AQUA 37</b> 1 PROGRAM				
 <p><b>RACK EQUIPMENT</b></p> <p>2 X C10 1 X 10728 1 X 15060</p>	230 V ~ 50 Hz 2,6 kW 2,8 kW (LS)	 275 H  Ø 280 LS  370x370	420x490x650 H 30 kg	<b>AQUA 37</b>  <b>AQUA 37 D</b>  <b>AQUA 37 LS</b>  <b>AQUA 37 LS D</b>
<b>AQUA 40</b> 1 PROGRAM				
 <p><b>RACK EQUIPMENT</b></p> <p>2 X C121 1 X 10728 1 X 15060</p>	230 V ~ 50 Hz 3,2 kW	 305 H  Ø 295 LS  400x400	450x535x700 H 37 kg	<b>AQUA 40</b>  <b>AQUA 40 D</b>  <b>AQUA 40 LS</b>  <b>AQUA 40 LS D</b>
<b>AQUA 50 MONO</b> 15 AMP MONOPHASE - 1 PROGRAM				
 <p><b>RACK EQUIPMENT</b></p> <p>1 X C40 1 X C44 1 X 15060</p>	230 V ~ 50 Hz 3,5 kW	 320 H  Ø 345  500x500	590x600x850 H 57 kg	<b>AQUA 50 MONO</b>  Surface filters
<b>AQUA 50</b> 2 PROGRAMS				
 <p><b>RACK EQUIPMENT</b></p> <p>1 X C40 1 X C44 1 X 15060</p>	400 V 3N ~ 50 Hz 5,2 kW	 320 H  Ø 345  500x500	590x600x850 H 57 kg	<b>AQUA 50</b>  <b>AQUA 50 D</b>  Surface filters



Model	Voltage	Capacity	Dimensions	Code
<b>AQUA 40 T</b> ELECTRONIC 4 PROGRAMS				
 <div style="border: 1px solid black; padding: 5px; margin-top: 10px;"> <p>RACK EQUIPMENT</p> <p>2 X C121 1 X 10728 1 X 15060</p> </div>	230 V ~ 50 Hz 3,2 kW	 305 H   Ø 295 LS   400x400	450x535x700 H 37 kg	<b>AQUA 40 T</b>  <b>AQUA 40 T DA</b>  <b>AQUA 40 T LS</b>  <b>AQUA 40 T LS DA</b>
<b>AQUA 50 T</b> ELECTRONIC 4 PROGRAMS				
 <div style="border: 1px solid black; padding: 5px; margin-top: 10px;"> <p>RACK EQUIPMENT</p> <p>1 X C40 1 X C44 1 X 15060</p> </div>	400 V 3N ~ 50 Hz 5,2 kW	 320 H   Ø 345   500x500	590x600x850 H 57 kg	<b>AQUA 50 T</b>  <b>AQUA 50 T DA</b>  Surface filters
<b>AQUA 80 T</b> ELECTRONIC 4 PROGRAMS				
 <div style="border: 1px solid black; padding: 5px; margin-top: 10px;"> <p><b>IMPROVED</b></p> <p>RACK EQUIPMENT</p> <p>1 X C40 1 X C44 1 X 15060</p> </div>	400 V 3N ~ 50 Hz 6,9 kW	 355 H   Ø 380   500x500	590x600x1290 H 69 kg	<b>AQUA 80 T</b>  <b>AQUA 80 T DA</b>  Surface filters

## OPTIONS

	XP		PS		DDE		ST		DB	
Model	220-240 V 50 Hz	380-415 V 3N 50 Hz	220-240 V 3 50 Hz	60 Hz	Electronic timer	Extra Power	Drain Pump	Detergent Dispenser	Soft start	Rinse-Aid Dispenser
<b>AQUA 35</b>	●	----	----	€	●	----	€	€	----	●
<b>AQUA 35 D</b>	●	----	----	€	●	----	€	€	----	●
<b>AQUA 37</b>	●	----	----	€	●	----	€	€	----	●
<b>AQUA 37 D</b>	●	----	----	€	●	----	€	€	----	●
<b>AQUA 37 LS</b>	●	----	----	€	●	----	€	€	----	●
<b>AQUA 37 LS D</b>	●	----	----	€	●	----	€	€	----	●
<b>AQUA 40</b>	●	□	□	€	●	€	€	€	----	●
<b>AQUA 40 D</b>	●	□	□	€	●	€	€	€	----	●
<b>AQUA 40 LS</b>	●	□	□	€	●	€	€	€	----	●
<b>AQUA 40 LS D</b>	●	□	□	€	●	€	€	€	----	●
<b>AQUA 50 MONO</b>	●	----	----	€	●	----	€	€	----	●
<b>AQUA 50*</b>	□	●	□	€	●	€	€	€	----	●
<b>AQUA 50 D</b>	□	●	□	€	●	€	€	€	----	●
<b>AQUA 40 T</b>	●	----	----	€	●	----	€	€	●	●
<b>AQUA 40 T DA</b>	●	----	----	€	●	----	€	€	●	●
<b>AQUA 40 T LS</b>	●	----	----	€	●	----	€	€	●	●
<b>AQUA 40 T LS DA</b>	●	----	----	€	●	----	€	€	●	●
<b>AQUA 50 T</b>	□	●	□	€	●	€	€	€	●	●
<b>AQUA 50 T DA</b>	□	●	□	€	●	€	€	€	●	●
<b>AQUA 80 T</b>	€	●	□	€	●	----	€	€	●	●
<b>AQUA 80 T DA</b>	€	●	□	€	●	----	€	€	●	●

**D** Built-in water softener

**DA** Built-in automatic water softener

**LS** Upper wash

**T** LED Eletronic (Soft Touch)

● Standard

---- Not available

□ Upon request

\* Construction according to UL-NSF standards upon request

**XP** Recommended with water 8-55 °C. AQUA 40 only with three-phase voltage, AQUA 50 only with standard voltage. For other voltages please contact us

	DBE	FS	PS+FS	CR	PS+DDE +FS	TS	BT	WRAS	PAP
Model	Peristaltic Rinse-Aid Disp.	Cold Rinse	PS + FS	Round Basket	PS + DDE + FS	thermostop System	Break tank	Wras	Booster pump
<b>AQUA 35</b>	€	€	€	€	€	●	----	----	----
<b>AQUA 35 D</b>	€	----	----	€	----	●	----	----	----
<b>AQUA 37</b>	€	€	€	€	€	●	----	----	----
<b>AQUA 37 D</b>	€	----	----	€	----	●	----	----	----
<b>AQUA 37 LS</b>	€	€	€	€	€	●	----	----	----
<b>AQUA 37 LS D</b>	€	----	----	€	----	●	----	----	----
<b>AQUA 40</b>	€	€	€	€	€	●	----	----	----
<b>AQUA 40 D</b>	€	----	----	€	----	●	----	----	----
<b>AQUA 40 LS</b>	€	€	€	€	€	●	----	----	----
<b>AQUA 40 LS D</b>	€	----	----	€	----	●	----	----	----
<b>AQUA 50 MONO</b>	€	----	----	----	----	●	----	----	
<b>AQUA 50*</b>	€	€	€	----	€	●	€	€	€
<b>AQUA 50 D</b>	€	€	----	----	----	●	----	----	----
<b>AQUA 40 T</b>	€	€	€	€	€	●	----	----	----
<b>AQUA 40 T DA</b>	€	€	€	€	----	●	----	----	----
<b>AQUA 40 T LS</b>	€	€	€	€	€	●	----	----	----
<b>AQUA 40 T LS DA</b>	€	€	€	€	----€	●	----	----	----
<b>AQUA 50 T</b>	€	€	€	----	€	●	€	€	€
<b>AQUA 50 T DA</b>	€	€	€	----	€	●	----	----	----
<b>AQUA 80 T</b>	€	€	€	----	€	●	€	€	€
<b>AQUA 80 T DA</b>	€	€	----	----	----	●	----	----	€

**SOFT START**

Progressive start of the wash pump

**BT - WRAS**

Booster pump included

**220-240 V 50 HZ**

For AQUA 50 max boiler heating element 4500 W

**380-415 V 3N 50 HZ**

For AQUA 40 only with extra power







**220-240 V 3 50 HZ**



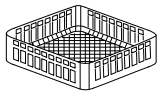
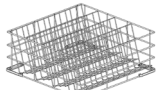
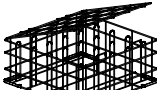

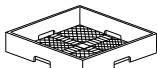
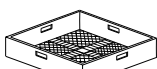
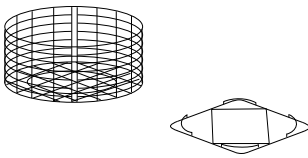
For AQUA 40 D with special voltage and PS, DDE is not available.

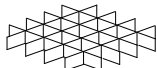
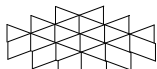
Option compatibility to be confirmed by the manufacturer after verification

Water supply 55 °C

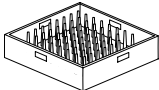
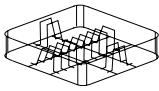
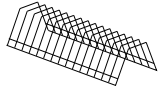
EAC label upon request

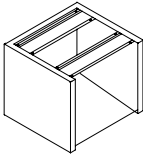
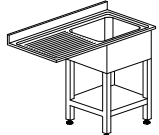
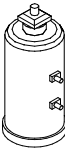
	Description	Capacity	Dimensions	Code
	GLASS BASKET		350x350x110 H 400x400x135 H 370x370x130 H	<b>10730</b> <b>C 121</b> <b>C 10</b>
	SLOPED GLASS BASKET	Ø 85 max Ø 100 max	370x370x210 H 500x500x200 H	<b>C 39</b> <b>C 26</b>
	REUSABLE CUP BASKET	5x5 Glass 30 < Ø < 90 mm H max 185 mm	500x500x235 H	<b>C 135</b> 
	SLOPED GLASS BASKET	Ø 90 max Ø 120 max	400x400x185 H 400x400x160 H	<b>C 123</b> <b>C 79</b>
	NARROW MESH CUTLERY BASKET		500x500x106 H	<b>C 41</b>
	LARGE MESH BASKET	For glasses	500x500x105 H	<b>C 44</b>
	ROUND GLASS BASKET	Basket	Ø 350x105 H	<b>C 21</b>
		Support	350x350	<b>C 36</b>
		Basket	Ø 370x120 H	<b>C 07</b>
	ROUND BASKET SUPPORT	Support	370x370	<b>C 37</b>
		Basket	Ø 400x145 H	<b>C 16</b>
		Support	400x400	<b>C 38</b>
	HOLDER FOR GLASS SUPPORT	For glass support (C112-C113-C114)	500x500x50 H	<b>C 111</b>
	GLASS SUPPORT	5x5 Glass Ø 87 mm (C111)	500x500x50 H	<b>C 112</b>
	GLASS SUPPORT	4x4 Glass Ø 110 mm (C111)	500x500x50 H	<b>C 113</b>
	GLASS SUPPORT	6x6 Glass Ø 72 mm (C111)	500x500x50 H	<b>C 114</b>

	Description	Capacity	Dimensions	Code	
	PLATE BASKET	18 plates	500x500x105 H	<b>C 40</b>	
	PLATE BASKET	10 plates	370x370x100 H	<b>C 03</b>	
		12 plates	400x400x120 H	<b>C 31</b>	
	SAUCER HOLDER	14 saucers	300x100x90 H	<b>10728</b>	
	CUTLERY BASKET		Ø 120x120 H	<b>15060</b>	
	SUPPORT	Stainless steel stand	592x535x500 H	<b>999900517</b>	
	SINK UNIT FOR UNDER-COUNTER MODELS	Sink 500x400x300H	1200x700x850 H	<b>K 5/20*</b>	
	WATER SOFTENER	12 l	Ø 200x500 H	<b>DEP 12</b>	
	AUTOMATIC WATER SOFTENER	12 l (max 800 l)	315x510x685 H	<b>DEP 12-AUT</b>	

\* Wooden cage +2% minimum + €  
Special dimensions for tables upon request  
Tables shown in right-to-left version



Double wall glass and dishwashers DUPLA line. Designed to meet the needs of bars, restaurants, hotels and pubs. Their aesthetics has been renewed; electro-mechanic and electronic version are available.

A wide choice of options may be chosen amongst, water softener, detergent dispenser, drain pump and the surface filters in order to adapt the machine to the most diverse uses.









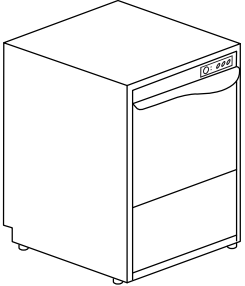

## ELECTRONIC VERSION

An electronic control panel is available for DUPLA T models. The LED panel displays the temperatures of both tank and boiler, the wash cycle and status and main alarm codes for malfunctions. You can now choose among four different washing programs to perfectly tailor the performances of the machine to the crockery that needs to be cleaned. The soft start function grants extra protection for fragile objects.

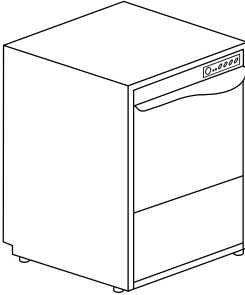
## FEATURES

- Double walled AISI 304 structure
- Pressed basket supports
- Double skin door with anti-shock system
- Deep-drawn and sloped tank for a perfect total drain
- Overflow and drain pipes integrated system, for a triple protection of the washing pump
- Non-drip roof to safeguard the hygiene of the freshly washed dishes
- Light wash and rinse arms, granting the best efficiency also in the event of weak pressure in the water mains (DUPLA 40 LS)
- S/S wash arms (DUPLA 50, DUPLA 50 MONO and DUPLA 50 T)
- Easy to remove nozzles, to help with daily cleaning operations
- Back flow prevention valve
- Rinse-aid dispenser (peristaltic version on demand)
- Thermostop system: the rinse starts only when the water in boiler reaches 85 °C
- CE Certified components
- Electronic version with four preset washing programs
- Automatic regeneration for touch models with built-in water softener
- Glasswashers available also with round basket
- Self-cleaning cycle on the TOUCH versions
- Soft Start wash pump on the TOUCH versions
- Additional upper surface filter (on demand only for DUPLA 50, DUPLA 50 MONO and DUPLA 50 T)

Model	Voltage	Capacity	Dimensions	Code
<b>DUPLA 40 LS</b> UPPER WASH - 1 PROGRAM				
	<p>RACK EQUIPMENT</p> <p>2 X C121 1 X 10728 1 X 15060</p> 	<p>230 V ~ 50 Hz 3,2 kW</p>	<p>305 H</p>  <p>Ø 295</p>  <p>400x400</p> 	<p>460x545x715 H 38 kg</p>
<b>DUPLA 50</b> 2 PROGRAMS				
	<p>RACK EQUIPMENT</p> <p>1 X C40 1 X C44 1 X 15060</p> 	<p>230 V ~ 50 Hz 3,45 kW</p> <p>400 V 3N~ 50 Hz 5,2 kW</p>	<p>310 H</p>  <p>Ø 325</p>  <p>500x500</p> 	<p>595x610x845 H 61 kg</p>



Model

Voltage

Capacity

Dimensions

Code

**DUPLA 40 LS T** UPPER WASH - ELECTRONIC 4 PROGRAMS

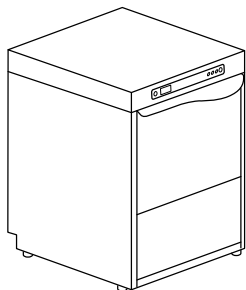

RACK  
EQUIPMENT

2 X C121  
1 X 10728  
1 X 15060



230 V ~ 50 Hz  
3,2 kW



305 H



Ø 295



400x400

460x545x715 H  
38 kg

**DUPLA 40 LS T**

**DUPLA 40 LS T DA**

**DUPLA 50 T** ELECTRONIC 4 PROGRAMS

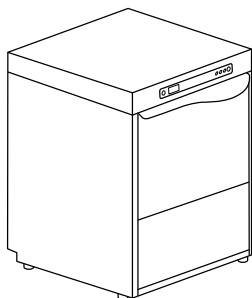

RACK  
EQUIPMENT

1 X C40  
1 X C44  
1 X 15060



400 V 3N ~ 50 Hz  
5,2 kW



310 H



Ø 325



500x500

595x610x845 H  
61 kg

**DUPLA 50 T**

**DUPLA 50 T DA**

Surface filters

## OPTIONS

						XP	PS	DDE	DB	ST
Model	220-240 V 50 Hz	380-415 V 3N 50 Hz	220-240 V 3 50 Hz	60 Hz	Electronic timer	Extra Power	Drain Pump	Detergent Dispenser	Rinse-Aid Dispenser	Soft start
<b>DUPLA 40 LS</b>	●	□	□	€	●	€	€	€	●	----
<b>DUPLA 40 LS D</b>	●	□	□	€	●	€	€	€	●	----
<b>DUPLA 50 MONO</b>	●	----	----	€	●	----	€	€	●	----
<b>DUPLA 50 MONO D</b>	●	----	----	€	●	----	€	€	●	----
<b>DUPLA 50 *</b>	□	●	□	€	●	€	€	€	●	----
<b>DUPLA 50 D</b>	□	●	□	€	●	€	€	€	●	----
<b>DUPLA 40 LS T</b>	●	----	----	€	●	----	€	€	●	●
<b>DUPLA 40 LS T DA</b>	●	----	----	€	●	----	€	€	●	●
<b>DUPLA 50 T</b>	□	●	□	€	●	€	€	€	●	●
<b>DUPLA 50 T DA</b>	□	●	□	€	●	€	€	€	●	●

**D** Built-in water softener

**DA** Built-in automatic water softener

**LS** Upper wash

**T** LED Eletronic (Soft Touch)

● Standard

---- Not available

□ Upon request

\* Construction according to UL-NSF standards upon request

**XP** Recommended with water 8-55 °C. For DUPLA 40 LS only with three-phase voltage, DUPLA 50 only with standard voltage. For other voltages please contact us

	DBE	CR	FS	PS+FS	PS+DDE +FS	TS	BT	WRAS	PAP
Model	Peristaltic Rinse-Aid Disp.	Round Basket	Cold Rinse	PS + FS	PS + DDE + FS	thermostop System	Break tank	Wras	Booster pump
<b>DUPLA 40 LS</b>	€	€	€	€	€	●	----	----	----
<b>DUPLA 40 LS D</b>	€	€	----	----	----	●	----	----	----
<b>DUPLA 50 MONO</b>	€	----	€	€	€	●	€	€	€
<b>DUPLA 50 MONO D</b>	€	----	----	----	----	●	----	----	----
<b>DUPLA 50 *</b>	€	----	€	€	€	●	€	€	€
<b>DUPLA 50 D</b>	€	----	----	----	----	●	----	----	€
<b>DUPLA 40 LS T</b>	€	€	€	€	€	●	----	----	----
<b>DUPLA 40 LS T DA</b>	€	€	€	€	€	●	----	----	----
<b>DUPLA 50 T</b>	€	----	€	€	€	●	€	€	€
<b>DUPLA 50 T DA</b>	€	----	€	€	€	●	----	----	----

**SOFT START**

Progressive start of the wash pump

**BT - WRAS**

Booster pump included

**220-240 V 50 HZ**

For DUPLA 50 max boiler heating element 4500 W

**380-415 V 3N 50 HZ**

For DUPLA 40 LS only with extra power







**220-240 V 3 50 HZ**

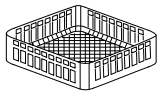
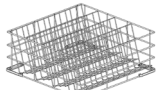
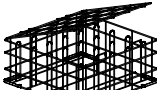

For DUPLA 40 LS D with special voltage and PS, DDE is not available.

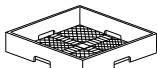
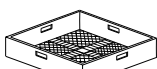
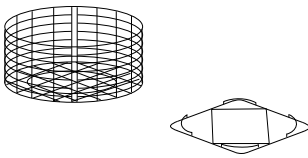
Option compatibility to be confirmed by the manufacturer after verification

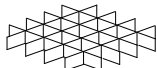
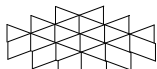
Water supply 55 °C

EAC label upon request

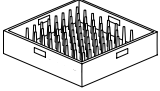
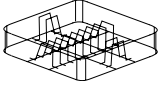
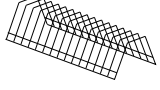
	Description	Capacity	Dimensions	Code
	GLASS BASKET		350x350x110 H 400x400x135 H 370x370x130 H	<b>10730</b> <b>C 121</b> <b>C 10</b>
	SLOPED GLASS BASKET	Ø 85 max Ø 100 max	370x370x210 H 500x500x200 H	<b>C 39</b> <b>C 26</b>
	REUSABLE CUP BASKET	5x5 Glass 30 < Ø < 90 mm H max 185 mm	500x500x235 H	<b>C 135</b> 
	SLOPED GLASS BASKET	Ø 90 max Ø 120 max	400x400x185 H 400x400x160 H	<b>C 123</b> <b>C 79</b>
	NARROW MESH CUTLERY BASKET		500x500x106 H	<b>C 41</b>
	LARGE MESH BASKET	For glasses	500x500x105 H	<b>C 44</b>
	ROUND GLASS BASKET	Basket	Ø 350x105 H	<b>C 21</b>
		Support	350x350	<b>C 36</b>
		Basket	Ø 370x120 H	<b>C 07</b>
	ROUND BASKET SUPPORT	Support	370x370	<b>C 37</b>
		Basket	Ø 400x145 H	<b>C 16</b>
		Support	400x400	<b>C 38</b>
	HOLDER FOR GLASS SUPPORT	For glass support (C112-C113-C114)	500x500x50 H	<b>C 111</b>
	GLASS SUPPORT	5x5 Glass Ø 87 mm (C111)	500x500x50 H	<b>C 112</b>
	GLASS SUPPORT	4x4 Glass Ø 110 mm (C111)	500x500x50 H	<b>C 113</b>
	GLASS SUPPORT	6x6 Glass Ø 72 mm (C111)	500x500x50 H	<b>C 114</b>

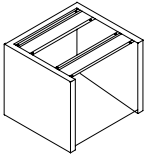
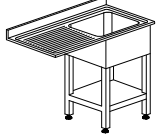
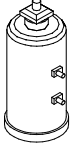
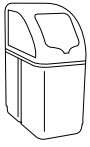
	Description	Capacity	Dimensions	Code	
	PLATE BASKET	18 plates	500x500x105 H	<b>C 40</b>	
	PLATE BASKET	10 plates	370x370x100 H	<b>C 03</b>	
		12 plates	400x400x120 H	<b>C 31</b>	
	SAUCER HOLDER	14 saucers	300x100x90 H	<b>10728</b>	
	CUTLERY BASKET		Ø 120x120 H	<b>15060</b>	
	SUPPORT	Stainless steel stand	592x535x500 H	<b>999900517</b>	
	SINK UNIT FOR UNDER-COUNTER MODELS	Sink 500x400x300H	1200x700x850 H	<b>K 5/20*</b>	
	WATER SOFTENER	12 l	Ø 200x500 H	<b>DEP 12</b>	
	AUTOMATIC WATER SOFTENER	12 l (max 800 l)	315x510x685 H	<b>DEP 12-AUT</b>	

\* Wooden cage +2% minimum + €  
Special dimensions for tables upon request  
Tables shown in right-to-left version



Latest generation KROMO dishwashers. These machines are built with fully double-skin body, completely deep-formed, designed for being silent and reliable. Beside the standard electronic versions with four programmable cycles, we have developed the PLUS models with guaranteed steady rinse temperature and pressure and two cycles with Hygiene+ superior features (LUX 60 EL).

Thanks to these latest technological features, the sturdy PLUS versions will promote the almost total elimination of the bacterial load. The customization of our new generation machines has never been so easy!

$A_0=30$   
**HYGIENE+**

## HYGIENE+ SYSTEM

The HYGIENE+ models perform long cycles at high temperatures to fulfill high levels of hygiene, now more essential than ever for our health. Designed and conceived upon rigorous disinfection parameters, the Hygiene+ models include 2 special cycles complying with  $A_0=30$  on the scale of thermo-disinfection according to the norm EN ISO 15883-1, a short one program of 180 seconds and a longer one of 630 seconds, ensuring compliance with high levels of hygiene thanks to high temperatures and long cycles.



## FEATURES

- Double skin AISI 304 machine and double skin insulated door
- Sloped deep-formed tank
- Wash arms in stainless steel with unblockable nozzles and lightweight rinse arms in composite material
- Deep-formed rack supports
- Anti-drop roof panel
- Suitable for Gastronorm 1/1 trays
- Multivoltage models
- Detergent and rinse-aid dosage setting, directly from the control panel (PLUS models)
- Wash and rinse temperatures displayed
- Anti back-flow valve available also DVGW or WRAS certified)
- Double tight-mesh filter system in stainless steel
- Programmable wash cycles (not on LUX 85 EL PLUS)
- HYGIENE+ Version: 2 special additional programs complying with  $A_0=30$  according to the norm EN ISO 15883-1
- Intuitive START button with multicolour backlight for a quick visualization of the machine status
- Self-cleaning cycle
- Soft Start wash pump
- Thermal insulation of boiler
- Soft door opening and programmable START function when the door gets closed
- OPTIMAL-RINSE (optimal rinse technology): water consumption rate among the lowest on the market, consequent reduction of electricity and chemicals consumptions
- Built-in peristaltic detergent dispenser and built-in rinse-aid dispenser (peristaltic rinse-aid dispenser included in the Plus versions)
- Water consumption and working time control system (PLUS versions)
- PLUS system for extra rinse guarantee (PLUS versions)
- Built-in automatic water softener available
- CONNECTIVITY remote control compliant with the HACCP norms (on request)
- Cold water rinse (on demand)
- Reverse osmosis connection for external device (PLUS versions)

## CONNECTIVITY 4.0 & APP

WHEREVER YOU ARE...  
YOUR DISHWASHER, JUST A CLICK AWAY

You will be constantly connected to the machine to monitor the work phases, review any eventual alarm and configure remotely the operating parameters according to your needs. Compliant with HACCP norms. Thanks to our brand new App, you will have access to connected machines and all commercial and technical documentation.

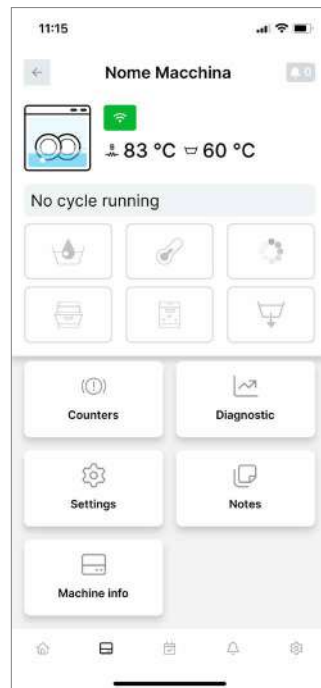

View all the working parameters and event records, working hours and any problem at any time.



In case of problem, the machine promptly alerts you. The technician can intervene remotely to solve the problem or anticipate the needed parts for an on-site intervention.



A daily activity report is available with all the events related to the dishwasher in a detailed spreadsheet with HACCP data.



Our Connectivity system is a revolutionary device limiting and facilitating the eventual intervention of a technician who can anticipate the necessary parts to be replaced, saving time and money.



## PLUS SYSTEM

GUARANTEED RINSE EVEN  
WITH LOW PRESSURE OF THE WATER INLET

We have developed an innovative rinsing system at constant temperature, consumption and water pressure, regardless of external conditions.

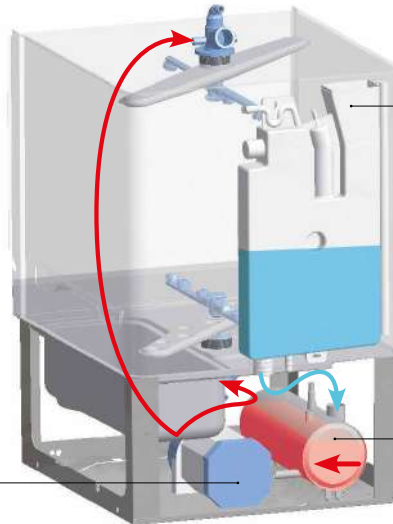

### BREAK TANK

The Break Tank system prevents the heated water of the boiler to go back and mix with the fresh water supply.

### ATMOSPHERIC BOILER

The water temperature in the boiler remains constant at 85°C throughout the rinse, as the boiler refill only occurs once the rinse cycle is done.

### RINSE PUMP

The water is sucked from the boiler through a rinse pump and is sent to the rinse nozzles. The correct pressure is ensured regardless of the water inlet pressure and temperature.













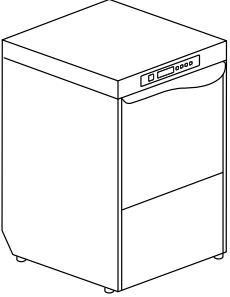



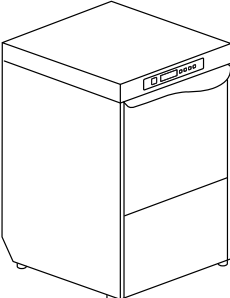





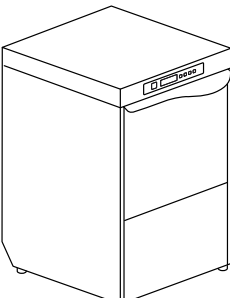

STABILIZED PRESSURE  
THROUGHOUT THE RINSE PHASE



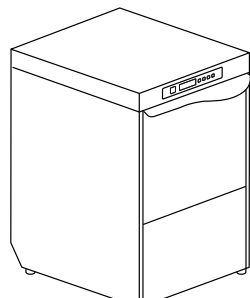







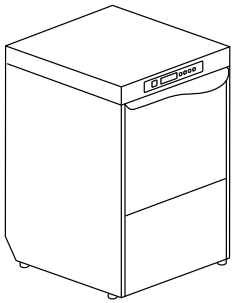



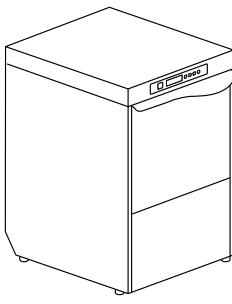

STEADY WATER  
TEMPERATURE IN THE  
BOILER (85°C)

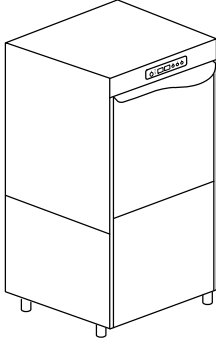

CLEANER WATER  
LESS WASTE

Model		Voltage	Capacity	Dimensions	Code
<b>LUX 40 EL</b> ELECTRONIC 4 PROGRAMS					
	<p><b>RACK EQUIPMENT</b></p> <p>2 X C121 1 X 10728 1 X 15060</p> 	<p>Multivoltage</p> <p>standard 230 V 50 Hz 3,05 kW</p> <p>-- 230 V 3 50 Hz 4,45 kW</p> <p>-- 400 V 3N 50 Hz 4,45 kW</p>	<p> 310 H</p> <p> ø 310</p> <p> 400x400</p>	<p>460x550x780 H 45 kg</p>	<b>LUX 40 EL</b>
					<b>LUX 40 EL DA</b>
<b>LUX 60 EL</b> ELECTRONIC 4 PROGRAMS					
	<p><b>RACK EQUIPMENT</b></p> <p>1 X C40 1 X C44 1 X 15060</p> 	<p>Multivoltage</p> <p>standard 400 V 3N 50 Hz 5,15 kW</p> <p>-- 230 V 3 50 Hz 5,15 kW</p> <p>-- 230 V 50 Hz 5,15 kW</p>	<p> 325 H</p> <p> ø 340</p> <p> 500x500</p>	<p>600x610x850 H 63,5 kg</p> <p> GN 1/1 530x325x25 H</p>	<b>LUX 60 EL</b>
					<b>LUX 60 EL DA</b>
<b>LUX 60 EL H+</b> ELECTRONIC 4 PROGRAMS					
	<p><b>A<sub>0</sub>=30</b> <b>HYGIENE +</b> </p> <p><b>RACK EQUIPMENT</b></p> <p>1 X C40 1 X C44 1 X 15060</p> 	<p>Multivoltage</p> <p>standard 400 V 3N 50 Hz 5,15 kW</p> <p>-- 230 V 3 50 Hz 5,15 kW</p> <p>-- 230 V 50 Hz 5,15 kW</p>	<p> 325 H</p> <p> ø 340</p> <p> 500x500</p>	<p>600x610x850 H 63,5 kg</p> <p> GN 1/1 530x325x25 H</p>	<b>LUX 60 EL H+</b>
					<b>LUX 60 EL DA H+</b>
<b>LUX 70 EL</b> ELECTRONIC 4 PROGRAMS					
	<p><b>RACK EQUIPMENT</b></p> <p>1 X C40 1 X C44 1 X 15060</p> 	<p>Multivoltage</p> <p>standard 400 V 3N 50 Hz 6,7 kW</p> <p>-- 230 V 3 50 Hz 6,7 kW</p> <p>-- 230 V 50 Hz 6,7 kW</p>	<p> 400 H</p> <p> ø 400</p> <p> 500x500</p>	<p>600x680x850 H 68 kg</p> <p> 600x400x25 H</p> <p> GN 1/1 530x325x25 H</p>	<b>LUX 70 EL</b>
					<b>LUX 70 EL DA</b>
					Surface filters

Model	Voltage	Capacity	Dimensions	Code	
<b>LUX 40 EL PLUS</b> ELECTRONIC 4 PROGRAMS					
	<b>RACK EQUIPMENT</b> 2 X C121 1 X 10728 1 X 15060	Multivoltage	 310 H  ø 310  400x400	<b>LUX 40 EL PLUS</b>	
		standard		<b>LUX 40 EL PLUS DA</b>	
		230 V 50 Hz 3,05 kW		460x550x780 H 46,5 kg	<b>LUX 40 EL PLUS HR</b>
		230 V 3 50 Hz 4,45 kW		<b>LUX 40 EL PLUS HR DA</b>	
400 V 3N 50 Hz 4,45 kW	HR: Cold water supply				
<b>LUX 60 EL PLUS H+</b> ELECTRONIC 6 PROGRAMS					
	$A_0=30$ <b>HYGIENE +</b> <b>RACK EQUIPMENT</b> 1 X C40 1 X C44 1 X 15060	Multivoltage	 325 H  ø 340  500x500	<b>LUX 60 EL PLUS H+</b>	
		standard		<b>LUX 60 EL PLUS DA H+</b>	
		400 V 3N 50 Hz 5,15 kW		600x610x850 H 65 kg	<b>LUX 60 EL PLUS HR H+</b>
		230 V 3 50 Hz 5,15 kW		 530x325x25 H	<b>LUX 60 EL PLUS HR DA H+</b>
230 V 50 Hz 5,15 kW	HR: Cold water supply				
<b>LUX 85 EL PLUS</b> ELECTRONIC 4 PROGRAMS					
	<b>RACK EQUIPMENT</b> 1 X C40 1 X C43 1 X C44 1 X 15060	400 V 3N ~ 50 Hz 10,2 kW	 440 H  ø 450  500x500	<b>LUX 85 EL PLUS</b>	
				600x700x1380 H 87 kg	
				 600x400x25 H	
				 530x325x25 H	

**A<sub>0</sub>=30** Special programs complying with A<sub>0</sub>=30 on the scale of thermo-disinfection according to the norm EN ISO 15883-1. The Hygiene+ models include 2 special cycles, a short one of 180 seconds and a longer one of 630 seconds, ensuring compliance with high levels of hygiene thanks to high temperatures and long cycles.

**PLUS** Rinse with constant temperature, pressure and stabilized consumption

**X** With special basket to be ordered

## OPTIONS

Model	220-240 V 50 Hz	380-415 V 3N 50 Hz	220-240 V 3.50 Hz	380-415 V 3.50 Hz	440 V 3.60 Hz	60 Hz	RO Osmosis Connection	XP Extra Power	PS Drain Pump	DDE Detergent Dispenser	DB Rinse-Aid Dispenser	DBE Peristaltic Rinse-Aid Disp.
<b>LUX 40 EL</b>	●	M	M	----	----	€	----	□	€	●	●	€
<b>LUX 40 EL DA</b>	●	M	M	----	----	€	----	□	€	●	●	€
<b>LUX 60 EL</b>	M	●	M	€	€	€	----	€	€	●	●	€
<b>LUX 60 EL DA</b>	M	●	M	----	----	€	----	€	€	●	●	€
<b>LUX 60 EL H+</b>	M	●	M	€	€	€	----	€	€	●	●	€
<b>LUX 60 EL H+ DA</b>	M	●	M	----	----	€	----	€	€	●	●	€
<b>LUX 70 EL</b>	□	●	M	----	----	€	----	----	€	●	●	€
<b>LUX 70 EL DA</b>	□	●	M	----	----	€	----	----	€	●	●	€
<b>LUX 40 EL PLUS</b>	●	M	M	----	----	€	□	□	€	●	----	●
<b>LUX 40 EL PLUS DA</b>	●	M	M	----	----	€	----	□	€	●	----	●
<b>LUX 40 EL PLUS HR</b>	●	M	M	----	----	€	□	□	€	●	----	●
<b>LUX 40 EL PLUS HR DA</b>	●	M	M	----	----	€	----	□	€	●	----	●
<b>LUX 60 EL PLUS H+</b>	M	●	M	€	€	€	□	€	€	●	----	●
<b>LUX 60 EL PLUS DA H+</b>	M	●	M	----	----	€	----	€	€	●	----	●
<b>LUX 60 EL PLUS HR H+</b>	M	●	M	€	€	€	□	€	€	●	----	●
<b>LUX 60 EL PLUS HR DA H+</b>	M	●	M	----	----	€	----	€	€	●	----	●
<b>LUX 85 EL PLUS</b>	€	●	□	----	----	€	□	€	€	●	----	●

● Standard

---- Not available

□ Upon request

**DA** Built-in automatic water softener

**M** Multivoltage

**XP** Recommended with water 8-55 °C. For LUX 40 EL only with standard voltage.  
For other voltages please contact us

Water supply 55 °C (not on HR version)

EAC label upon request

Model	ST	FS	CR	PS+FS	TS	CONNECTIVITY	BT	WRAS	DVGW	PAP	FLOAT
	Soft start	Cold Rinse	Round Basket	PS + FS	Electronic timer+ thermo-stop System	Connectivity (HACCP)	Break tank	Wras	DVGW	Booster pump	Probes Lack det. and rinse aid
LUX 40 EL	●	€	€	€	●	€	€	€	€	€	€
LUX 40 EL DA	●	----	€	----	●	€	----	----	----	€	€
LUX 60 EL	●	€	----	€	●	€	€	€	€	€	€
LUX 60 EL DA	●	----	----	----	●	€	----	€	€	€	€
LUX 60 EL H+	●	€	----	€	●	€	€	€	€	€	€
LUX 60 EL H+ DA	●	----	----	----	●	€	----	€	€	€	€
LUX 70 EL	●	€	----	€	●	€	€	€	€	€	€
LUX 70 EL DA	●	----	----	----	●	€	----	€	€	----	€
LUX 40 EL PLUS	●	€	€	€	●	€	●	€	€	●	€
LUX 40 EL PLUS DA	●	----	€	----	●	€	----	----	----	●	€
LUX 40 EL PLUS HR	●	----	€	----	●	€	●	----	----	●	€
LUX 40 EL PLUS HR DA	●	----	€	----	●	€	----	----	----	●	€
LUX 60 EL PLUS H+	●	€	----	€	●	€	●	€	€	●	€
LUX 60 EL PLUS DA H+	●	----	----	----	●	€	----	----	---	●	€
LUX 60 EL PLUS HR H+	●	----	----	----	●	€	●	----	----	●	€
LUX 60 EL PLUS HR DA H+	●	----	----	----	●	€	----	----	----	●	€
LUX 85 EL PLUS	●	----	----	----	●	----	●	€	€	●	€

**380-415 V 3N 50 HZ** For the models LUX 40 EL "upon request" provide extra power  
**220-240 V 3 50 HZ**

**220 -240 V 50 HZ** For the models LUX 85 PLUS max boiler heating element 6000 W

**CONNECTIVITY** Includes HACCP option. 10 year plan

**BT - WRAS** Booster pump included







**DVGW** Components prescribed by DVGW on request (check option compatibility with the manufacturer)

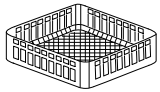

**SOFT START** Progressive start of the wash pump

**H+ (HYGIENE+)** 2 cycles of 630 and 180 seconds with high temperatures, reaching up to 70 °C for washing and 90°C for rinsing

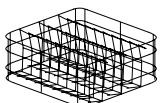
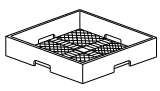
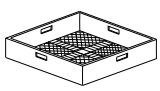
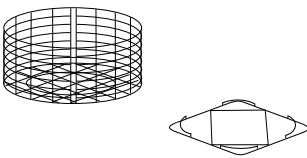
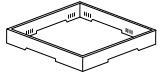
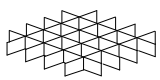
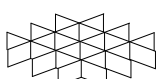
All models: independent wash and rinse arms

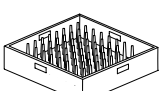
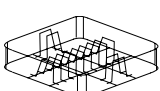
Option compatibility to be confirmed by the manufacturer after verification

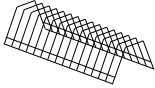
	Description	Capacity	Dimensions	Code	
	GLASS BASKET		400x400x135 H	<b>C 121</b>	
	SLOPED GLASS BASKET	Ø 100 max	500x500x200 H	<b>C 26</b>	
	REUSABLE CUP BASKET	5x5 Glass 30 < Ø < 90 mm H max 185 mm	500x500x235 H	<b>C 135</b> 	
	SLOPED GLASS BASKET	Ø 90 max Ø 120 max	400x400x185 H 400x400x160 H	<b>C 123</b> <b>C 79</b>	
	NARROW MESH CUTLERY BASKET		500x500x106 H	<b>C 41</b>	
	LARGE MESH BASKET	For glasses	500x500x105 H	<b>C 44</b>	
	ROUND GLASS BASKET ROUND BASKET SUPPORT	Basket Support	Ø 400x145 H 400x400	<b>C 16</b> <b>C 38</b>	
	HOLDER FOR GLASS SUPPORT	For glass support (C112-C113-C114)	500x500x50 H	<b>C 111</b>	
	GLASS SUPPORT	5x5 Glass Ø 87 mm (C111)	500x500x50 H	<b>C 112</b>	
	GLASS SUPPORT	4x4 Glass Ø 110 mm (C111)	500x500x50 H	<b>C 113</b>	
	GLASS SUPPORT	6x6 Glass Ø 72 mm (C111)	500x500x50 H	<b>C 114</b>	
	PLATE BASKET	18 plates	500x500x105 H	<b>C 40</b>	
	PLATE BASKET	12 plates	400x400x120 H	<b>C 31</b>	

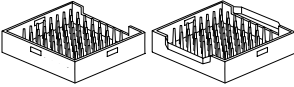
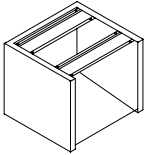
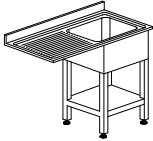
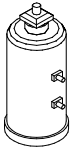
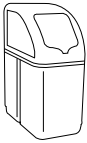
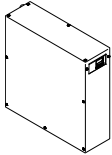
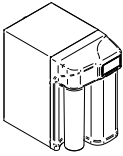
	Description	Capacity	Dimensions	Code	
	SAUCER HOLDER	14 saucers	300x100x90 H	<b>10728</b>	
	CUTLERY BASKET		Ø 120x120 H	<b>15060</b>	
	GASTRONORM TRAYS BASKET	6 pcs, max. depth 25 mm	500x500x105 H 500x500x105 H	<b>C 43</b> <b>C 43/B</b>	
	SUPPORT	Stainless steel stand	592x535x500 H	<b>999900517</b>	
	SINK UNIT FOR UNDER-COUNTER MODELS	Sink 500x400x300H	1200x700x850 H	<b>K 5/20*</b>	
	WATER SOFTENER	12 l	Ø 200x500 H	<b>DEP 12</b>	
	AUTOMATIC WATER SOFTENER	12 l (max 800 l)	315x510x685 H	<b>DEP 12-AUT</b>	
	OSMOSIS FOR LUX 40 EL PLUS	230 V 50 Hz - 250 W 5° C - 30° C Flow rate 180-210l/h - 15°C Not suitable for machine with integrated water softener Special basket dotation	145x560x580 H 25 Kg	<b>K OS180</b>	
	OSMOSIS FOR LUX 60 EL PLUS H+	230 V 50 Hz - 250 W 5° C - 30° C Flow rate 240 l/h Not suitable for machine with integrated water softener Special basket dotation	270x411x451 H 18 Kg	<b>K OS240</b>	

\* Wooden cage +2% minimum + €  
Special dimensions for tables upon request  
Tables shown in right-to-left version



We simply combined the highest specs and ultimate new technology to the time-tested name and features. PREMIUM is our answer to the new high standards of hygiene and cleanliness of the worldwide market, keeping our renowned low operating costs thanks to the Optimal Rinse system. Our HYGIENE+ cycles will guarantee to work safely by keeping top sanitation levels. The compact model with lower usable height, the settable additional cycle and the available self-

monitoring technology and Connectivity makes the PREMIUM the range you have been expecting. An intuitive and interactive electronic panel will lead you through the new functions of your dishwasher. Its self-diagnosis system notifies any anomaly and clearly shows the different steps of the cycle and status of your dishwasher. Eight wash cycles (ten for the HYGIENE+ version) and the easy change of voltage make these machines incredibly versatile and easy to install.



$A_0=60$   
**HYGIENE+**

## HYGIENE+ SYSTEM

Our HYGIENE + models, with high temperatures and long cycles, ensure compliance with high levels of hygiene, nowadays more essential than ever for our personal health. We designed this range according to strict standards and parameters of thermal disinfection. All our HYGIENE + models obtain the  $A_0$  60 level, reducing pathogenic microorganisms and bacterial load according to the norm EN ISO 15883-1. Two cycles with high temperatures (180 and 630 seconds), reaching up to 75°C for washing and 90°C for rinsing, guarantee a full compliance with the disinfection principles.



## FEATURES

- OPTIMAL-RINSE (optimal rinse technology): water consumption rate among the lowest on the market, consequent reduction of electricity and chemicals consumptions
- Soft door opening and programmable START function when the door gets closed
- Combined system of wash and rinse arms in stainless steel with unblockable nozzles
- Innovative S/S filter improving the filtration of the wash water
- Partial drain of the waste wash water before rinsing
- Standard version: Eight wash cycles, six with partial drain of the wash water and two with total drain of the wash water before rinsing
- HYGIENE+ version: Ten wash cycles, six with partial drain of the wash water, two with total drain of the wash water before rinsing and two HYGIENE+ programs
- Double skin machine and double skin insulated door
- Electronic control panel with TFT screen and multichromatic START key to instantly view all functions
- Self-diagnostic system with two different control levels for user and service people depending on the failure
- Easy-change voltage setting, directly from the cables connection
- Water consumption and working time control system
- Detergent and rinse-aid peristaltic dispensers included
- NEW: Detergent and rinse-aid dosage setting, directly from the control panel
- Built-in drain pump
- Thermostop with Energy Saving device
- Self-cleaning cycle
- Soft Start wash pump
- Thermal insulation of boiler
- CONNECTIVITY remote control compliant with the HACCP norms (on request)
- Automatic softened version with continuous self-regeneration

## CONNECTIVITY 4.0 & APP

WHEREVER YOU ARE...

YOUR DISHWASHER, JUST A CLICK AWAY

You will be constantly connected to the machine to monitor the work phases, review any eventual alarm and configure remotely the operating parameters according to your needs. Compliant with HACCP norms. Thanks to our brand new App, you will have access to connected machines and all commercial and technical documentation.

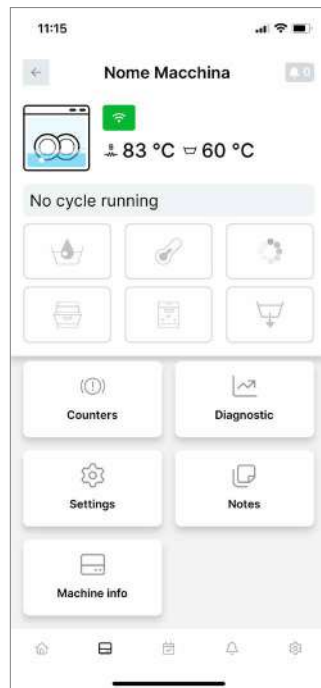

View all the working parameters and event records, working hours and any problem at any time.



In case of problem, the machine promptly alerts you. The technician can intervene remotely to solve the problem or anticipate the needed parts for an on-site intervention.



A daily activity report is available with all the events related to the dishwasher in a detailed spreadsheet with HACCP data.



Our Connectivity system is a revolutionary device limiting and facilitating the eventual intervention of a technician who can anticipate the necessary parts to be replaced, saving time and money.

## PLUS SYSTEM

GUARANTEED RINSE EVEN

WITH LOW PRESSURE OF THE WATER INLET

We have developed an innovative rinsing system at constant temperature, consumption and water pressure, regardless of external conditions.



STEADY WATER TEMPERATURE IN THE BOILER (85°C)



STABILIZED PRESSURE THROUGHOUT THE RINSE PHASE



CLEANER WATER  
LESS WASTE

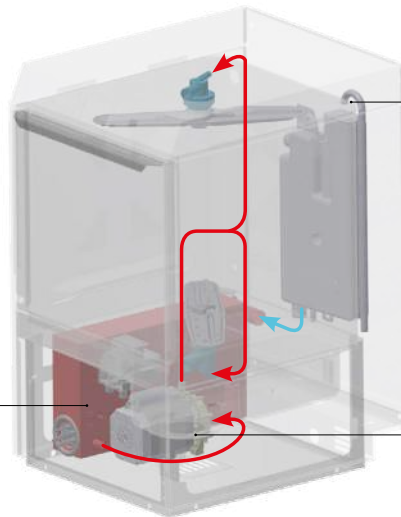

## BREAK TANK

The Break Tank system prevents the heated water of the boiler to go back and mix with the fresh water supply.

## ATMOSPHERIC BOILER

The water temperature in the boiler remains constant at 85°C throughout the rinse, as the boiler refill only occurs once the rinse cycle is done.

## RINSE PUMP

The water is sucked from the boiler through a rinse pump and is sent to the rinse nozzles. The correct pressure is ensured regardless of the water inlet pressure and temperature.

## ENERGY RECOVERY

(Heat recovery and steam condenser)











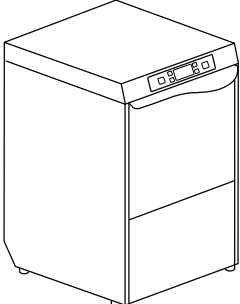

The ENERGY RECOVERY system uses the heat produced by the machine to preheat the inlet cold water. This is an immediate saving on energy costs. Additionally, an optimal temperature in the dishwashing area is achieved as the air is no more affected by steam and humidity.

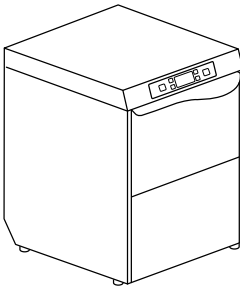



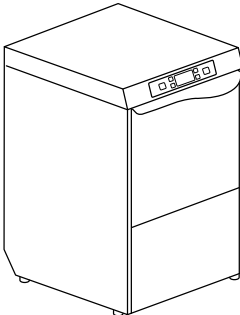

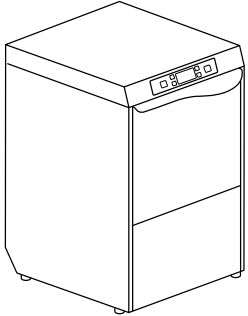

Heat Recovery

# PREMIUM

CONNECTED GLASS AND DISHWASHERS  
WITH CLEAN WATER TECHNOLOGY

Model	Voltage	Capacity	Dimensions	Code
<b>PREMIUM 40</b> ELECTRONIC 8 PROGRAMS				
 <div data-bbox="375 504 550 728" style="border: 1px solid black; padding: 5px;"> <p>RACK EQUIPMENT</p> <p>2 X C121 1 X 10728 1 X 15060</p> </div>	Multivoltage	 310 H   Ø 310   400x400	460x550x780 H 47 kg	<b>PREMIUM 40</b>
	standard 230 V 50 Hz 3,25 kW			<b>PREMIUM 40 DA</b>
	230 V 3 50 Hz 4,75 kW			<b>PREMIUM 40 HR</b>
	400 V 3N 50 Hz 4,75 kW -- HR: Cold water supply			<b>PREMIUM 40 HR DA</b>
<b>PREMIUM 50 SMALL</b> ELECTRONIC 8 PROGRAMS				
 <div data-bbox="375 1108 550 1332" style="border: 1px solid black; padding: 5px;"> <p>RACK EQUIPMENT</p> <p>1 X C40 1 X C44 1 X 15060</p> </div>	Multivoltage	 260 H   Ø 260   500x500	600x610x730 H 60 kg	<b>PREMIUM 50 SMALL</b>
	400 V 3N 50 Hz 6,35 kW			<b>PREMIUM 50 SMALL DA</b>
	230 V 3 50 Hz 6,35 kW			<b>PREMIUM 50 SMALL HR</b>
	230 V 50 Hz 6,35 kW -- HR: Cold water supply			<b>PREMIUM 50 SMALL HR DA</b>
<b>PREMIUM 50</b> ELECTRONIC 8 PROGRAMS				
 <div data-bbox="375 1713 550 1937" style="border: 1px solid black; padding: 5px;"> <p>RACK EQUIPMENT</p> <p>1 X C40 1 X C44 1 X 15060</p> </div>	Multivoltage	 340 H   Ø 340   500x500	600x610x850 H 65,5 kg   530x325x25 H	<b>PREMIUM 50</b>
	400 V 3N 50 Hz 6,65 kW			<b>PREMIUM 50 DA</b>
	230 V 3 50 Hz 6,65 kW			<b>PREMIUM 50 HR</b>
	230 V 50 Hz 6,65 kW -- HR: Cold water supply			<b>PREMIUM 50 HR DA</b>

Model	Voltage	Capacity	Dimensions	Code
<b>PREMIUM 50 H+</b> ELECTRONIC 10 PROGRAMS				
 <p><b>A<sub>0</sub>=60 HYGIENE +</b></p> <p><b>RACK EQUIPMENT</b></p> <ul style="list-style-type: none"> <li>1 X C40</li> <li>1 X C44</li> <li>1 X 15060</li> </ul> 	Multivoltage			<b>PREMIUM 50 H+</b>
	standard 400 V 3N 50 Hz 6,65 kW	 340 H	600x610x850 H 65,5 kg	<b>PREMIUM 50 DA H+</b>
	230 V 3 50 Hz 6,65 kW	 Ø 340	 530x325x25 H	<b>PREMIUM 50 HR H+</b>
	230 V 50 Hz 6,65 kW	 500x500		<b>PREMIUM 50 HR DA H+</b>
HR: Cold water supply				

**A<sub>0</sub>=60** Special programs complying with A<sub>0</sub>=60 on the scale of thermo-disinfection according to the norm EN ISO 15883-1. All our Hygiene+ models reach the A<sub>0</sub> 60 level defining the minimum reduction level of pathogenic microorganisms and bacterial load. In addition, our Plus Rinsing System guarantees a perfect rinse with steady temperature and water pressure for optimum hygienic results

**X** With special basket to be ordered

## OPTIONS

Model	220-240 V 50 Hz	380-415 V 3N 50 Hz	220-240 V 3 50 Hz	60 Hz	RO Osmosis Connection	PS Drain Pump	DDE Detergent Dispenser	ST Soft start	DBE Peristaltic Rinse-Aid Disp.
<b>PREMIUM 40</b>	●	M	M	€	□	●	●	●	●
<b>PREMIUM 40 DA</b>	●	M	M	€	----	●	●	●	●
<b>PREMIUM 40 HR</b>	●	M	M	€	□	●	●	●	●
<b>PREMIUM 40 HR DA</b>	●	M	M	€	----	●	●	●	●
<b>PREMIUM 50 SMALL</b>	M	●	M	€	□	●	●	●	●
<b>PREMIUM 50 SMALL DA</b>	M	●	M	€	----	●	●	●	●
<b>PREMIUM 50 SMALL HR</b>	M	●	M	€	□	●	●	●	●
<b>PREMIUM 50 SMALL HR DA</b>	M	●	M	€	----	●	●	●	●
<b>PREMIUM 50</b>	M	●	M	€	□	●	●	●	●
<b>PREMIUM 50 DA</b>	M	●	M	€	----	●	●	●	●
<b>PREMIUM 50 HR</b>	M	●	M	€	□	●	●	●	●
<b>PREMIUM 50 HR DA</b>	M	●	M	€	----	●	●	●	●
<b>PREMIUM 50 H+</b>	M	●	M	€	□	●	●	●	●
<b>PREMIUM 50 DA H+</b>	M	●	M	€	----	●	●	●	●
<b>PREMIUM 50 HR H+</b>	M	●	M	€	□	●	●	●	●
<b>PREMIUM 50 HR DA H+</b>	M	●	M	€	----	●	●	●	●

**DA** Built-in automatic water softener

**HR** In case of osmotic water supply, it is suggested to feed the machine with electrical conductivity of more than 200 microsiemens  
In case of cold water supply for rinse (8-15 °C), the heat recovery option is mandatory

**M** Multivoltage

● Standard







---- Not available

□ Upon request

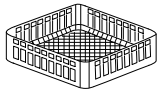
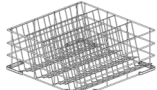

Model	FS Cold Rinse	CR Round Basket	TS Electronic timer + thermostat System	CONNECTIVITY Connectivity (HACCP)	BT Break tank	WRAS Wras	DVGW DVGW	PR Rinse pump	FLOAT Probes Lack det. and rinse aid
<b>PREMIUM 40</b>	€	€	●	€	●	€	€	●	€
<b>PREMIUM 40 DA</b>	----	€	●	€	----	----	----	●	€
<b>PREMIUM 40 HR</b>	----	€	●	€	●	----	----	●	€
<b>PREMIUM 40 HR DA</b>	----	€	●	€	----	----	----	●	€
<b>PREMIUM 50 SMALL</b>	€	----	●	€	●	€	€	●	€
<b>PREMIUM 50 SMALL DA</b>	----	----	●	€	----	----	----	●	€
<b>PREMIUM 50 SMALL HR</b>	----	----	●	€	●	----	----	●	€
<b>PREMIUM 50 SMALL HR DA</b>	----	----	●	€	----	----	----	●	€
<b>PREMIUM 50</b>	€	----	●	€	●	€	€	●	€
<b>PREMIUM 50 DA</b>	----	----	●	€	----	----	----	●	€
<b>PREMIUM 50 HR</b>	----	----	●	€	●	----	----	●	€
<b>PREMIUM 50 HR DA</b>	----	----	●	€	----	----	----	●	€
<b>PREMIUM 50 H+</b>	€	----	●	€	●	€	€	●	€
<b>PREMIUM 50 DA H+</b>	----	----	●	€	----	----	----	●	€
<b>PREMIUM 50 HR H+</b>	----	----	●	€	●	----	----	●	€
<b>PREMIUM 50 HR DA H+</b>	----	----	●	€	----	----	----	●	€

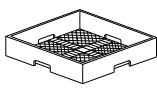
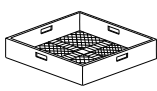
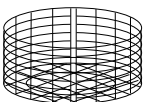
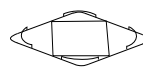
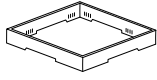
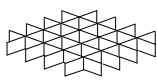
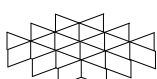
- SOFT START** Progressive start of the wash pump
  - WRAS - DVGW** Not available with FS
  - DVGW** Components prescribed by DVGW on request (check option compatibility with the manufacturer)
  - CONNECTIVITY** Includes HACCP option. 10 year plan
  - 380-415 V 3N 50 HZ  
220-240 V 3 50 HZ** For the models PREMIUM 40 "upon request" provide extra power
  - H+ (HYGIENE+)** 2 cycles of 630 and 180 seconds with high temperatures, reaching up to 75 °C for washing and 90°C for rinsing
- Option compatibility to be confirmed by the manufacturer after verification
- Water supply 55 °C
- EAC label upon request

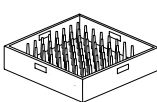
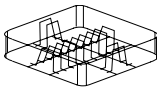
# PREMIUM

	Description	Capacity	Dimensions	Code	
	GLASS BASKET		400x400x135 H	<b>C 121</b>	
	SLOPED GLASS BASKET	Ø 100 max	500x500x200 H	<b>C 26</b>	
	REUSABLE CUP BASKET	5x5 Glass 30 < Ø < 90 mm H max 185 mm	500x500x235 H	<b>C 135</b> 	
	SLOPED GLASS BASKET	Ø 90 max Ø 120 max	400x400x185 H 400x400x160 H	<b>C 123</b> <b>C 79</b>	
	NARROW MESH CUTLERY BASKET		500x500x106 H	<b>C 41</b>	
	LARGE MESH BASKET	For glasses	500x500x105 H	<b>C 44</b>	
	ROUND GLASS BASKET	Basket	Ø 400x145 H	<b>C 16</b>	
	ROUND BASKET SUPPORT	Support	400x400	<b>C 38</b>	
	HOLDER FOR GLASS SUPPORT	For glass support (C112-C113-C114)	500x500x50 H	<b>C 111</b>	
	GLASS SUPPORT	5x5 Glass Ø 87 mm (C111)	500x500x50 H	<b>C 112</b>	
	GLASS SUPPORT	4x4 Glass Ø 110 mm (C111)	500x500x50 H	<b>C 113</b>	
	GLASS SUPPORT	6x6 Glass Ø 72 mm (C111)	500x500x50 H	<b>C 114</b>	
	PLATE BASKET	18 plates	500x500x105 H	<b>C 40</b>	
	PLATE BASKET	12 plates	400x400x120 H	<b>C 31</b>	

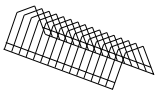

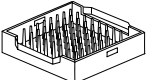
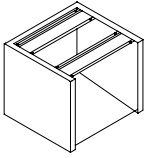
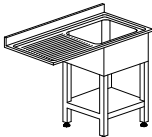
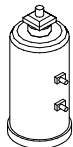
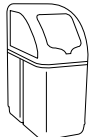
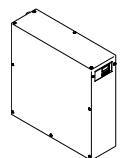
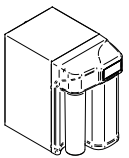
	Description	Capacity	Dimensions	Code	
	SAUCER HOLDER	14 saucers	300x100x90 H	<b>10728</b>	
	CUTLERY BASKET		Ø 120x120 H	<b>15060</b>	
	GASTRONORM TRAYS BASKET	6 pcs, max. depth 25 mm	500x500x105 H	<b>C 43/B</b>	
	SUPPORT	Stainless steel stand	592x535x500 H	<b>999900517</b>	
	SINK UNIT FOR UNDER-COUNTER MODELS	Sink 500x400x300H	1200x700x850 H	<b>K 5/20*</b>	
	WATER SOFTENER	12 l	Ø 200x500 H	<b>DEP 12</b>	
	AUTOMATIC WATER SOFTENER	12 l (max 800 l)	315x510x685 H	<b>DEP 12-AUT</b>	
	OSMOSIS FOR LUX 40 EL PLUS	230 V 50 Hz - 250 W 5° C - 30° C Flow rate 180-210l/h - 15°C Not suitable for machine with integrated water softener Special basket dotation	145x560x580 H 25 Kg	<b>K OS180</b>	
	OSMOSIS FOR LUX 60 EL PLUS H+	230 V 50 Hz - 250 W 5° C - 30° C Flow rate 240 l/h Not suitable for machine with integrated water softener Special basket dotation	270x411x451 H 18 Kg	<b>K OS240</b>	

\* Wooden cage +2% minimum + €

Special dimensions for tables upon request

Tables shown in right-to-left version

# HOOD 70

ROBUST AND ESSENTIAL  
HOOD-TYPE DISHWASHERS



You asked and we listened! We are thrilled to announce our brand new range: HOOD 70. These robust and essential hood-type dishwashers simply make sense. Nothing superfluous:

solid S/S body with single skin hood, sloped tank, innovative and light arms, controlled temperatures and, only if needed, detergent dispenser and drain pump. Wash, rinse, restart. It is really that simple.



## ELECTRONIC VERSION







The intuitive LED control panel of the HOOD 70 L model will display if the correct temperatures of both tank and boiler have been reached. You can choose among 3 different wash programs to perfectly tailor the performances of the machine to the crockery that needs to be cleaned.

## FEATURES

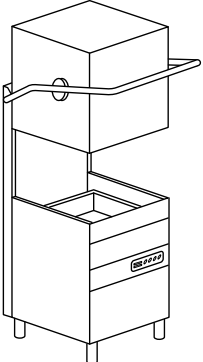





- 1 wash cycle (HOOD 70)
- 3 wash cycles (HOOD 70 L)
- Self-cleaning cycle on the electronic version (HOOD 70 L)
- Tank and boiler thermometers
- Hood operating start/stop functions
- Deep-formed tank
- Innovative system of coupled wash and rinse arms in polypropylene and fiber of glass
- Standard surface filters in polypropylene
- Pump filter
- Standard rinse aid dispenser
- Easily removable basket support
- Linear or corner layouts

# HOOD 70

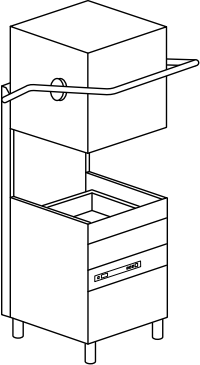
ROBUST AND ESSENTIAL  
HOOD-TYPE DISHWASHERS

Model		Voltage	Capacity	Dimensions	Code
<b>HOOD 70</b>	1 PROGRAM				
	<p><b>New</b></p> <p><b>RACK EQUIPMENT</b></p> <p>1 X C40 1 X C44 1 X 15060</p> 	<p>400 V 3N ~ 50 Hz 6,55 kW</p>	<p> 355 H</p> <p> Ø 410</p> <p> 500x500</p>	<p>720x735x 1445/1880 H 100 kg</p> <p> <b>X</b></p> <p>530x325x25 H</p>	<b>HOOD 70</b>

**X** With special basket to be ordered

Model		Voltage	Capacity	Dimensions	Code
<b>HOOD 70 L</b>	3 PROGRAMS				
	<p><b>NEW</b></p> <p>RACK EQUIPMENT</p> <p>1 X C40 1 X C44 1 X 15060</p> 	<p>400 V 3N ~ 50 Hz 6,55 kW</p>	<p> 355 H</p> <p> Ø 410</p> <p> 500x500</p>	<p>720x735x 1445/1880 H 100 kg</p> <p> GN 1/1</p> <p>530x325x25 H</p>	<b>HOOD 70 L</b>

## OPTIONS

		PS	DDE	DB	TS	DF
Model	380-415 V 3N 50 Hz	Drain Pump	Detergent Dispenser	Rinse-Aid Dispenser	thermostop System	Surface Filters Kit
<b>HOOD 70</b>	●	€	€	●	●	●
<b>HOOD 70 L</b>	●	€	€	●	●	●

● Standard







--- Not available

**L** LED electronic

EAC label upon request

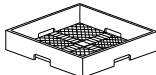
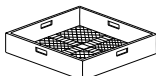
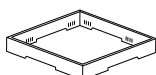
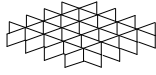
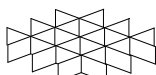
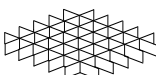
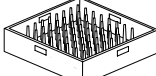
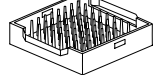
Water supply 55 °C

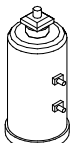

	Description	Capacity	Dimensions	Code	
	SLOPED GLASS BASKET	Ø 100 max	500x500x200 H	<b>C 26</b>	
	REUSABLE CUP BASKET	5x5 Glass 30 < Ø < 90 mm H max 185 mm	500x500x235 H	<b>C 135</b> 	
	NARROW MESH CUTLERY BASKET		500x500x106 H	<b>C 41</b>	
	LARGE MESH BASKET	For glasses	500x500x105 H	<b>C 44</b>	
	HOLDER FOR GLASS SUPPORT	For glass support (C112-C113-C114)	500x500x50 H	<b>C 111</b>	
	GLASS SUPPORT	5x5 Glass Ø 87 mm (C111)	500x500x50 H	<b>C 112</b>	
	GLASS SUPPORT	4x4 Glass Ø 110 mm (C111)	500x500x50 H	<b>C 113</b>	
	GLASS SUPPORT	6x6 Glass Ø 72 mm (C111)	500x500x50 H	<b>C 114</b>	
	PLATE BASKET	18 plates	500x500x105 H	<b>C 40</b>	
	GASTRONORM TRAYS BASKET	6 pcs, max. depth 25 mm	500x500x105 H	<b>C 43/B</b>	
	CUTLERY BASKET		Ø 120x120 H	<b>15060</b>	
	WATER SOFTENER	12 l	Ø 200x500 H	<b>DEP 12</b>	
	AUTOMATIC WATER SOFTENER	12 l (max 800 l)	315x510x685 H	<b>DEP 12-AUT</b>	

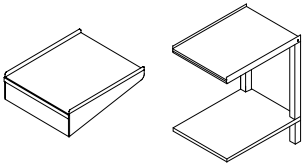
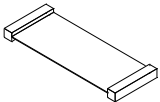
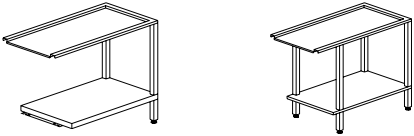
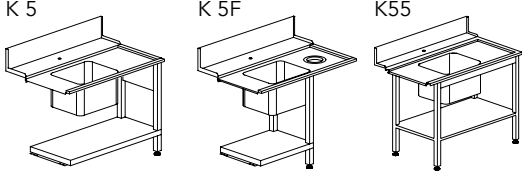
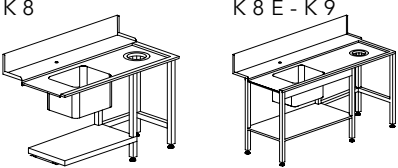
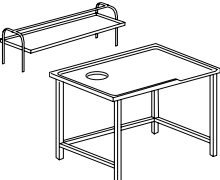
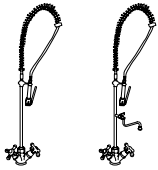
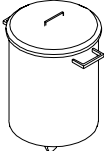

	Description	Capacity	Dimensions	Code	
	SHELF	Only for exit	600x510	<b>K 2ME</b>	
	TABLE		650x510x860 H	<b>K 4/65</b>	
	HOOD CONNECTION SHELF			<b>KIT DUO</b>	
	TABLE		700x590x860 H	<b>K 4/70B</b>	
			1200x590x860 H	<b>K 4/120B</b>	
			1200x590x860 H	<b>K 4B</b>	
	Sink 500x400x270 H		1200x730x860 H	<b>K 5</b>	
			1200x730x860 H	<b>K 5F</b>	
			1200x730x860 H	<b>K 55</b>	
	Sink 500x400x270 H		1500x730x860 H	<b>K 8</b>	
			1500x730x860 H	<b>K 8E</b>	
			1800x730x860 H	<b>K 9</b>	
	SHELF		1515x620x660 H	<b>K 7M16*</b>	
	GRADING TABLE WITH RUBBER RING	Waste hole and special dimensions upon request	2315x620x660 H	<b>K 7M24*</b>	
	FLEXIBLE SHOWER complete with mixing group and lever tap, to be fixed to the wall		1000 H	<b>K 1</b>	
	FLEXIBLE SHOWER complete with mixing group and lever tap, to be fixed to the wall and intermediate tap		1000 H	<b>K 1HR</b>	
	STAINLESS STEEL WASTE BIN	Basic model	Ø 400x570 H	<b>K 7/1</b>	
		With wheels	Ø 400x570 H	<b>K 7/2</b>	
		With wheels and pedal board	Ø 400x570 H	<b>K 7/3</b>	

\* Wooden cage +2% minimum + €

Special dimensions for tables upon request

Tables shown in right-to-left version

# HOOD 80 - 110

SINGLE SKIN HOOD-TYPE  
DISHWASHERS



The KROMO hood-type dishwashers offer a wide range of models, from the ones that can be equipped with the most advanced options, to the most innovative types, designed with avant-garde electronics and with all options included. Our products have evolved together with our experience and our customers' hints and insights.

Therefore we are able to produce tailor-made models that fulfil our final customers' criteria of functionality, reliability and versatility. Our aim is to reduce consumptions in terms of energy, water and chemical products, therefore granting the final user global savings, but also less pollution and waste of natural resources.



## TOUCH PANEL

The LED panel displays the temperatures of both tank and boiler, the wash cycle and status and eventual main alarm codes for malfunctions. There are four wash cycles available. These innovations are designed to provide KROMO's customers with even more user friendly machines, maintaining the same high performances. The soft start function grants extra protection for fragile objects.

## FEATURES HOOD 80 / HOOD 110







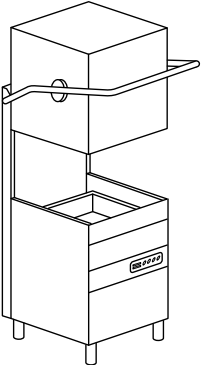

- Two wash cycles
- Hood operating start/stop functions
- Tank deep-formed bottom
- Pump filter
- Built-in rinse-aid pump
- Tank and boiler thermometres
- Easily removable basket support
- Linear or corner layouts
- Innovative system of coupled wash and rinse arms in polypropylene and fiber of glass ( HOOD 80 )
- Independent stainless steel wash arms and polypropylene and fiber of glass rinse arms ( HOOD 110 )
- Surface filters in polypropylene ( HOOD 80 )
- S/S surface filters ( HOOD 110 )
- Built-in water softener available ( HOOD 110 )

## FEATURES HOOD 80 T / HOOD 110 T



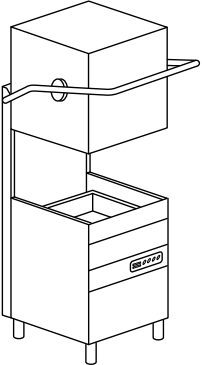



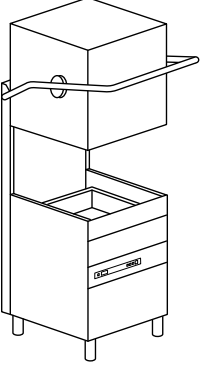

- Easy and intuitive LED control panel
- Four wash cycles
- Hood operating start/stop functions
- Tank deep-formed bottom
- Built-in rinse-aid pump
- Tank and boiler thermometres
- Surface filters
- Easily removable basket support
- Linear or corner layouts
- Self-cleaning cycle
- Innovative system of coupled wash and rinse arms in polypropylene and fiber of glass ( HOOD 80 T )
- Independent stainless steel wash arms and polypropylene and fiber of glass rinse arms ( HOOD 110 T )
- Surface filters in polypropylene ( HOOD 80 T )
- S/S surface filters ( HOOD 110 T )
- Automatic built-in water softener available ( HOOD 110 T )

# HOOD 80 - 110

SINGLE SKIN HOOD-TYPE  
DISHWASHERS

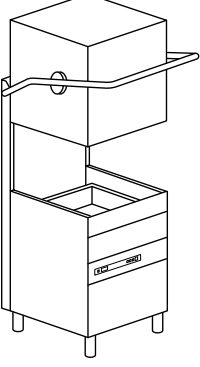
Model		Voltage	Capacity	Dimensions	Code
<b>HOOD 80</b>	2 PROGRAMS				
	<p>RACK EQUIPMENT</p> <p>2 X C40 1 X C44 2 X 15060</p> 	400 V 3N ~ 50 Hz 6,9 kW	 Ø 410   500x500	<p>720x735x 1445/1880 H 100 kg</p> <p> GN 1/1</p> <p>530x325x25 H</p>	<b>HOOD 80</b>
<b>HOOD 110</b>	2 PROGRAMS				
	<p>RACK EQUIPMENT</p> <p>2 X C40 1 X C44 2 X 15060</p> 	400 V 3N ~ 50 Hz 10,2 kW	 Ø 410   500x500	<p>720x735x 1445/1880 H 100 kg</p> <p> GN 1/1</p> <p>530x325x25 H</p>	<p><b>HOOD 110</b></p> <p><b>HOOD 110 D</b></p>

**X** With special basket to be ordered

Model		Voltage	Capacity	Dimensions	Code
<b>HOOD 80 T</b>	ELECTRONIC 4 PROGRAMS				
	<p>RACK EQUIPMENT</p> <p>2 X C40 1 X C44 2 X 15060</p> 	400 V 3N ~ 50 Hz 6,9 kW	 Ø 410   500x500	<p>720x735x 1445/1880 H 100 kg</p> <p> GN 1/1 530x325x25 H</p>	<p><b>HOOD 80 T</b></p> <p><b>HOOD 80 T DA</b></p>
<b>HOOD 110 T</b>	ELECTRONIC 4 PROGRAMS				
	<p>RACK EQUIPMENT</p> <p>2 X C40 1 X C44 2 X 15060</p> 	400 V 3N ~ 50 Hz 10,2 kW	 Ø 410   500x500	<p>720x735x 1445/1880 H 100 kg</p> <p> GN 1/1 530x325x25 H</p>	<p><b>HOOD 110 T</b></p> <p><b>HOOD 110 T DA</b></p>

# HOOD 80 - 110

SINGLE SKIN HOOD-TYPE  
DISHWASHERS

## OPTIONS

Model							XP	PS	DDE
	220-240 V 50 Hz	380-415 V 3N 50 Hz	220-240 V 3 50 Hz	380-415 V 3 50 Hz	440 V 3 60 Hz	60 Hz	Extra Power	Drain Pump	Detergent Dispenser
<b>HOOD 80</b>	€	●	□	----	----	€	€	€	€
<b>HOOD 110 *</b>	€	●	□	----	----	€	€	€	€
<b>HOOD 110 D</b>	€	●	□	----	----	€	€	€	€
<b>HOOD 80 T</b>	€	●	□	----	----	€	€	€	€
<b>HOOD 80 T DA</b>	€	●	□	----	----	€	€	€	€
<b>HOOD 110 T</b>	€	●	□	----	----	€	€	€	€
<b>HOOD 110 T DA</b>	€	●	□	----	----	€	€	€	€

- Standard
- Upon request
- Not available
- D** Built-in water softener
- DA** Built-in automatic water softener
- T** LED Eletronic (Soft Touch)
- \* Construction according to UL-NSF standards upon request

EAC label upon request

Water supply 55 °C

	DB	DBE	TS	ST	BT	WRAS	DVGW	PAP	DF
Model	Rinse-Aid Dispenser	Peristaltic Rinse-Aid Disp.	Electronic timer + thermostop System	Soft start	Break tank	Wras	DVGW	Booster pump	Surface Filters Kit
<b>HOOD 80</b>	●	€	●	----	€	€	€	€	●
<b>HOOD 110 *</b>	●	€	●	----	€	€	€	€	●
<b>HOOD 110 D</b>	●	€	●	----	----	----	----	€	●
<b>HOOD 80 T</b>	●	€	●	●	€	€	€	€	●
<b>HOOD 80 T DA</b>	●	€	●	●	----	----	----	€	●
<b>HOOD 110 T</b>	●	€	●	●	€	€	€	€	●
<b>HOOD 110 T DA</b>	●	€	●	●	----	----	----	€	●

**230-240 V 50 HZ** For HOOD 110 total power 7,2 kW upon request

**XP** In case of cold water supply for rinse 8 °C 55 °C, and without any heat recovery, the extra power option is mandatory. + 3000 W with standard voltage only, for other voltages please contact us. In case of cold water supply for rinse 8-15 °C, We recommend the heat recovery option, if available on the selected model







**BT - WRAS - DVGW** Booster pump included

**DVGW** Components prescribed by DVGW on request (check option compatibility with the manufacturer)

Option compatibility to be confirmed by the manufacturer after verification

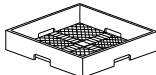
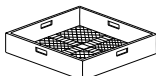
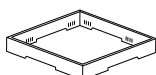
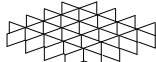
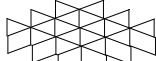
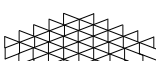
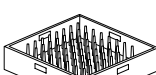
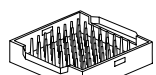
# HOOD 80 - 110

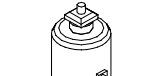
## ACCESSORIES

	Description	Capacity	Dimensions	Code	
	SLOPED GLASS BASKET	Ø 100 max	500x500x200 H	<b>C 26</b>	
	REUSABLE CUP BASKET	5x5 Glass 30 < Ø < 90 mm H max 185 mm	500x500x235 H	<b>C 135</b> 	
	NARROW MESH CUTLERY BASKET		500x500x106 H	<b>C 41</b>	
	LARGE MESH BASKET	For glasses	500x500x105 H	<b>C 44</b>	
	HOLDER FOR GLASS SUPPORT	For glass support (C112-C113-C114)	500x500x50 H	<b>C 111</b>	
	GLASS SUPPORT	5x5 Glass Ø 87 mm (C111)	500x500x50 H	<b>C 112</b>	
	GLASS SUPPORT	4x4 Glass Ø 110 mm (C111)	500x500x50 H	<b>C 113</b>	
	GLASS SUPPORT	6x6 Glass Ø 72 mm (C111)	500x500x50 H	<b>C 114</b>	
	PLATE BASKET	18 plates	500x500x105 H	<b>C 40</b>	
	GASTRONORM TRAYS BASKET	6 pcs, max. depth 25 mm	500x500x105 H	<b>C 43/B</b>	
	CUTLERY BASKET		Ø 120x120 H	<b>15060</b>	
	WATER SOFTENER	12 l	Ø 200x500 H	<b>DEP 12</b>	
	AUTOMATIC WATER SOFTENER	12 l (max 800 l)	315x510x685 H	<b>DEP 12-AUT</b>	

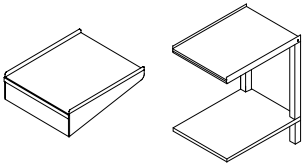
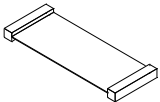
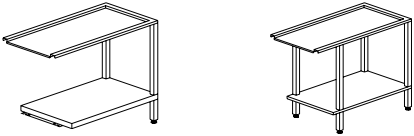
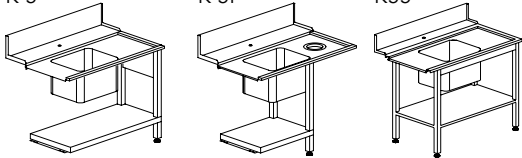
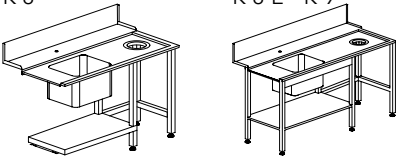
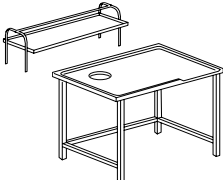
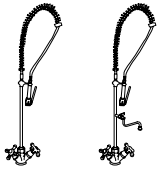
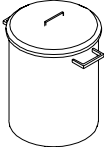

	Description	Capacity	Dimensions	Code	
	SHELF	Only for exit	600x510	<b>K 2ME</b>	
	TABLE		650x510x860 H	<b>K 4/65</b>	
	HOOD CONNECTION SHELF			<b>KIT DUO</b>	
K 4/70 B - K 4/120 B 	K 4B		700x590x860 H 1200x590x860 H 1200x590x860 H	<b>K 4/70B</b> <b>K 4/120B</b> <b>K 4B</b>	
K 5 K 5F K55 		Sink 500x400x270 H	1200x730x860 H 1200x730x860 H 1200x730x860 H	<b>K 5</b> <b>K 5F</b> <b>K 55</b>	
K 8 K 8 E - K 9 		Sink 500x400x270 H	1500x730x860 H 1500x730x860 H 1800x730x860 H	<b>K 8</b> <b>K 8E</b> <b>K 9</b>	
	SHELF		1515x620x660 H 2315x620x660 H	<b>K 7M16*</b> <b>K 7M24*</b>	
	GRADING TABLE WITH RUBBER RING	Waste hole and special dimensions upon request	1600x1000x850 H 2400x1000x850 H	<b>K 7A/1600*</b> <b>K 7A/2400*</b>	
	FLEXIBLE SHOWER complete with mixing group and lever tap, to be fixed to the wall		1000 H	<b>K 1</b>	
	FLEXIBLE SHOWER complete with mixing group and lever tap, to be fixed to the wall and intermediate tap		1000 H	<b>K 1HR</b>	
	STAINLESS STEEL WASTE BIN	Basic model With wheels With wheels and pedal board	Ø 400x570 H Ø 400x570 H Ø 400x570 H	<b>K 7/1</b> <b>K 7/2</b> <b>K 7/3</b>	

\* Wooden cage +2% minimum + €

Special dimensions for tables upon request

Tables shown in right-to-left version

# HOOD 110 I

INSULATED  
HOOD-TYPE DISHWASHERS



The KROMO hood-type dishwashers offer a wide range of models, from the ones that can be equipped with the most advanced options, to the most innovative types, designed with avant-garde electronics and with all options included. Our products have evolved together with our experience and our customers' hints and insights.

Therefore we are able to produce tailor-made models that fulfil our final customers' criteria of functionality, reliability and versatility. Our aim is to reduce consumptions in terms of energy, water and chemical products, therefore granting the final user global savings, but also less pollution and waste of natural resources.



## TOUCH PANEL

The LED panel displays the temperatures of both tank and boiler, the wash cycle and status and eventual main alarm codes for malfunctions. There are four wash cycles available. These innovations are designed to provide KROMO's customers with even more user friendly machines, maintaining the same high performances. The soft start function grants extra protection for fragile objects.

## FEATURES HOOD 110 I





- Two wash cycles
- Hood operating start/stop functions
- Tank deep-formed bottom
- Pump filter
- S/S surface filters
- Double skin insulated hood
- Built-in rinse-aid pump
- Tank and boiler thermometres
- Easily removable basket support
- Linear or corner layouts
- Independent stainless steel wash arms and polypropylene and fiber of glass rinse arms
- Built-in water softener available

## FEATURES HOOD 110 I T



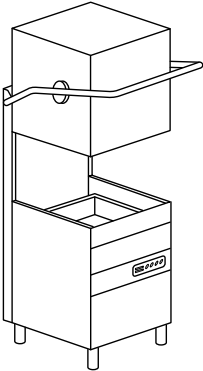

- Easy and intuitive LED control panel
- Four wash cycles
- Hood operating start/stop functions
- Tank deep-formed bottom
- Built-in rinse-aid pump
- Tank and boiler thermometres
- Surface filters
- Easily removable basket support
- Double skin insulated hood
- Linear or corner layouts
- Independent stainless steel wash arms and polypropylene and fiber of glass rinse arms
- Self-cleaning cycle
- Automatic built-in water softener available

# HOOD 110 I

INSULATED  
HOOD-TYPE DISHWASHERS

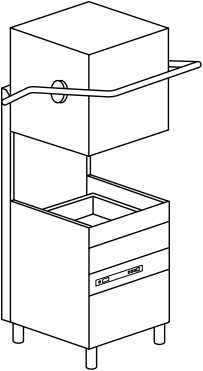
Model		Voltage	Capacity	Dimensions	Code
<b>HOOD 110 I</b>	2 PROGRAMS				
	<p>RACK EQUIPMENT</p> <p>2 X C40 1 X C44 2 X 15060</p> 	400 V 3N ~ 50 Hz 10,2 kW	 ø 410   500x500	<p>720x735x 1445/1880 H 100 kg</p> <p> GN 1/1 530x325x25 H</p>	<p><b>HOOD 110 I</b></p> <p><b>HOOD 110 I D</b></p>

**X** With special basket to be ordered

Model	Voltage	Capacity	Dimensions	Code
<b>HOOD 110 I T</b> 	ELECTRONIC 4 PROGRAMS  <b>RACK EQUIPMENT</b> 2 X C40 1 X C44 2 X 15060 	400 V 3N ~ 50 Hz 10,2 kW   ø 410   500x500	720x735x 1445/1880 H 100 kg   530x325x25 H	<b>HOOD 110 I T</b>  <b>HOOD 110 I T DA</b>

## OPTIONS

	220-240 V 50 Hz		380-415 V 50 Hz		220-240 V 60 Hz		380-415 V 60 Hz		440 V 60 Hz		XP	PS	DDE	DB
Model	3N		3N		3N		3N		3N		Extra Power	Drain Pump	Detergent Dispenser	Rinse-Aid Dispenser
<b>HOOD 110 I</b>	€	●	□	----	----	€	€	€	€	€	€	€	€	●
<b>HOOD 110 I D</b>	€	●	□	----	----	€	€	€	€	€	€	€	€	●
<b>HOOD 110 I T</b>	€	●	□	----	----	€	€	€	€	€	€	€	€	●
<b>HOOD 110 I T DA</b>	€	●	□	----	----	€	€	€	€	€	€	€	€	●

- Standard
- Upon request
- Not available
- I Insulated hood
- D Built-in water softener
- DA Built-in automatic water softener
- T LED Eletronic (Soft Touch)

EAC label upon request

Water supply 55 °C

Model	DBE	TS	ST	BT	WRAS	DVGW	PAP	ID	DF
	Peristaltic Rinse-Aid Disp.	Electronic timer + thermostat System	Soft start	Break tank	Wras	DVGW	Booster pump	Double Skin	Surface Filters Kit
<b>HOOD 110 I</b>	€	●	----	€	€	€	€	●	●
<b>HOOD 110 I D</b>	€	●	----	----	----	----	€	●	●
<b>HOOD 110 I T</b>	€	●	●	€	€	€	€	●	●
<b>HOOD 110 I T DA</b>	€	●	●	----	----	----	€	●	●







**230-240 V 50 HZ** For HOOD 110 I total power 7,2 kW upon request

**XP** In case of cold water supply for rinse 8 °C 55 °C, and without any heat recovery, the extra power option is mandatory. + 3000 W with standard voltage only, for other voltages please contact us. In case of cold water supply for rinse 8-15 °C, We recommend the heat recovery option, if available on the selected model

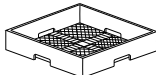
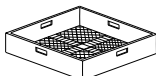
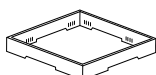
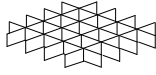
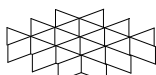
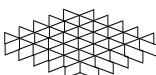
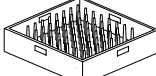
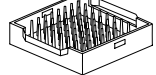

**BT - WRAS - DVGW** Booster pump included

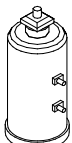
**DVGW** Components prescribed by DVGW on request (check option compatibility with the manufacturer)

Option compatibility to be confirmed by the manufacturer after verification

	Description	Capacity	Dimensions	Code
	SLOPED GLASS BASKET	Ø 100 max	500x500x200 H	<b>C 26</b>
	REUSABLE CUP BASKET	5x5 Glass 30 < Ø < 90 mm H max 185 mm	500x500x235 H	<b>C 135</b> 
	NARROW MESH CUTLERY BASKET		500x500x106 H	<b>C 41</b>
	LARGE MESH BASKET	For glasses	500x500x105 H	<b>C 44</b>
	HOLDER FOR GLASS SUPPORT	For glass support (C112-C113-C114)	500x500x50 H	<b>C 111</b>
	GLASS SUPPORT	5x5 Glass Ø 87 mm (C111)	500x500x50 H	<b>C 112</b>
	GLASS SUPPORT	4x4 Glass Ø 110 mm (C111)	500x500x50 H	<b>C 113</b>
	GLASS SUPPORT	6x6 Glass Ø 72 mm (C111)	500x500x50 H	<b>C 114</b>
	PLATE BASKET	18 plates	500x500x105 H	<b>C 40</b>
	GASTRONORM TRAYS BASKET	6 pcs, max. depth 25 mm	500x500x105 H	<b>C 43/B</b>
	CUTLERY BASKET		Ø 120x120 H	<b>15060</b>
	WATER SOFTENER	12 l	Ø 200x500 H	<b>DEP 12</b>
	AUTOMATIC WATER SOFTENER	12 l (max 800 l)	315x510x685 H	<b>DEP 12-AUT</b>

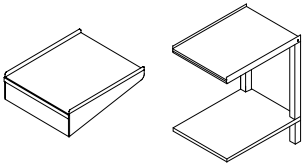
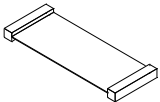
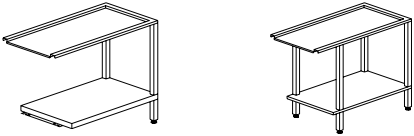
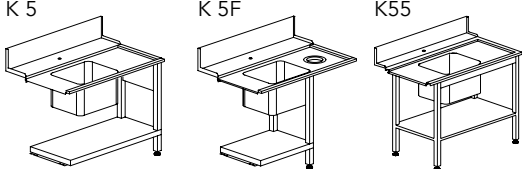
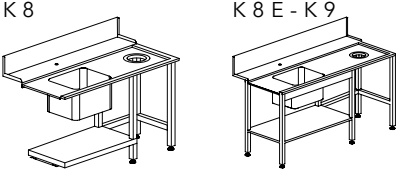
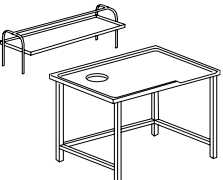

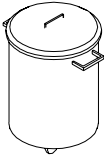
	Description	Capacity	Dimensions	Code	
	SHELF	Only for exit	600x510	<b>K 2ME</b>	
	TABLE		650x510x860 H	<b>K 4/65</b>	
	HOOD CONNECTION SHELF			<b>KIT DUO</b>	
	TABLE		700x590x860 H	<b>K 4/70B</b>	
			1200x590x860 H	<b>K 4/120B</b>	
			1200x590x860 H	<b>K 4B</b>	
	Sink 500x400x270 H		1200x730x860 H	<b>K 5</b>	
			1200x730x860 H	<b>K 5F</b>	
			1200x730x860 H	<b>K 55</b>	
	Sink 500x400x270 H		1500x730x860 H	<b>K 8</b>	
			1500x730x860 H	<b>K 8E</b>	
			1800x730x860 H	<b>K 9</b>	
	SHELF		1515x620x660 H	<b>K 7M16*</b>	
	GRADING TABLE WITH RUBBER RING	Waste hole and special dimensions upon request	2315x620x660 H	<b>K 7M24*</b>	
	FLEXIBLE SHOWER complete with mixing group and lever tap, to be fixed to the wall		1000 H	<b>K 1</b>	
	FLEXIBLE SHOWER complete with mixing group and lever tap, to be fixed to the wall and intermediate tap		1000 H	<b>K 1HR</b>	
	STAINLESS STEEL WASTE BIN	Basic model	Ø 400x570 H	<b>K 7/1</b>	
		With wheels	Ø 400x570 H	<b>K 7/2</b>	
		With wheels and pedal board	Ø 400x570 H	<b>K 7/3</b>	

\* Wooden cage +2% minimum + €

Special dimensions for tables upon request

Tables shown in right-to-left version

# HOOD 130 LUX

LATEST GENERATION  
HOOD-TYPE DISHWASHERS



The latest generation KROMO hoodtype dishwashers. These machines are built with fully double-skin hoodtype, designed for being silent and reliable. Beside the standard electronic versions with four programmable cycles, we have developed the PLUS models with guaranteed steady rinse temperature and pressure and two cycles with HYGIENE+ superior features ( $A_0=30$  on the scale

of thermo-disinfection according to the norm EN ISO 15883-1). Thanks to these latest technological features, the sturdy PLUS versions will promote the almost total elimination of the bacterial load. The customization of our new generation machines has never been so easy!

**A<sub>0</sub>=30**  
**HYGIENE +**

## HYGIENE+ SYSTEM

The HYGIENE+ models perform long cycles at high temperatures to fulfill high levels of hygiene, now more essential than ever for our health. These special programs comply with A<sub>0</sub>=30 on the scale of thermo-disinfection according to the norm EN ISO 15883-1. The HYGIENE+ models include 2 special cycles, a short one of 180 seconds and a longer one of 630 seconds, ensuring compliance with high levels of hygiene thanks to high temperatures and long cycles.

## FEATURES

- Easy and intuitive electronic control panel
- Modification of the dosage of detergent and rinse-aid directly on the control panel (PLUS versions)
- Remote control panel available on request instead of the standard control panel (PLUS versions)
- Four customizable programs
- Hygiene + version (H+ models): two special additional programs complying with A<sub>0</sub>=30 according to the norm EN ISO 15883-1
- Double skin insulated hood
- Deep tank
- Double tank filters, with dirt collection system and pump filter (improved system for a better filtration of the wash water)
- Self-cleaning vertical pump
- Rinse-aid and detergent dispensers included (peristaltic rinse-aid dispenser included on Plus versions)
- Water consumption and working time control system (PLUS versions)
- Easy to access for maintenance
- Anti-drop roof panel
- Easily removable basket support
- Linear or corner layouts
- Self-cleaning cycle
- Built-in peristaltic detergent dispenser and built-in rinse-aid dispenser (peristaltic rinse-aid dispenser included in the PLUS versions)
- The PLUS system grants a constant rinse temperature and pressure (PLUS models)
- LIFT: automatic hood lift at the end of cycle
- HR: ENERGY RECOVERY system ( HOOD 130 LUX PLUS HR H+ )
- CONNECTIVITY remote control compliant with the HACCP norms (on request)
- Predisposition for connection to an external device of reverse osmosis (on request on PLUS versions)



## CONNECTIVITY 4.0 & APP

WHEREVER YOU ARE...  
YOUR DISHWASHER, JUST A CLICK AWAY

You will be constantly connected to the machine to monitor the work phases, review any eventual alarm and configure remotely the operating parameters according to your needs. Compliant with HACCP norms. Thanks to our brand new App, you will have access to connected machines and all commercial and technical documentation.

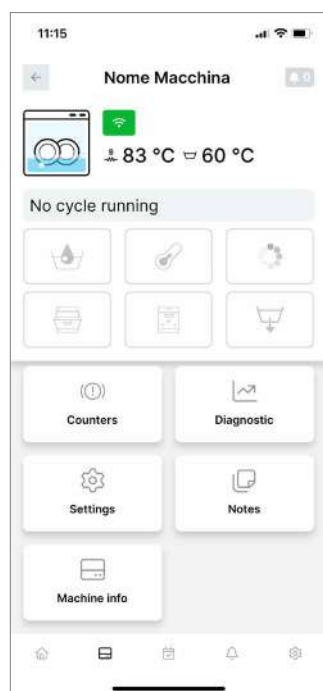

View all the working parameters and event records, working hours and any problem at any time.



In case of problem, the machine promptly alerts you. The technician can intervene remotely to solve the problem or anticipate the needed parts for an on-site intervention.



A daily activity report is available with all the events related to the dishwasher in a detailed spreadsheet with HACCP data.



Our Connectivity system is a revolutionary device limiting and facilitating the eventual intervention of a technician who can anticipate the necessary parts to be replaced, saving time and money.

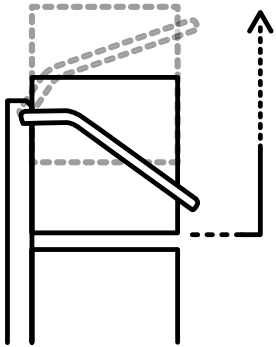

## IMPROVED LIFT SYSTEM:

### AUTOMATIC TWO-STEP HOOD LIFT AT THE END OF THE CYCLE

The hydraulic system has been replaced by an electric motor. Its simplicity limits maintenance and the formation of limescale. The latter, freeing up space, allows to add more options to the LIFT models such as the integrated automatic softener.

## PLUS SYSTEM

### GUARANTEED RINSE EVEN WITH LOW PRESSURE OF THE WATER INLET

We have developed an innovative rinsing system at constant temperature, consumption and water pressure, regardless of external conditions.

## ATMOSPHERIC BOILER

The water temperature in the boiler remains constant at 85°C throughout the rinse, as the boiler refill only occurs once the rinse cycle is done.

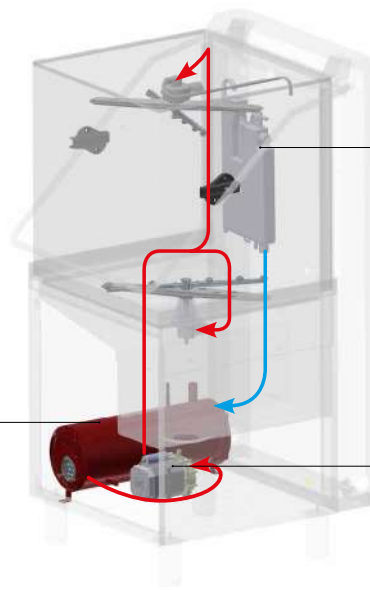

## BREAK TANK

The Break Tank system prevents the heated water of the boiler to go back and mix with the fresh water supply.

## RINSE PUMP

The water is sucked from the boiler through a rinse pump and is sent to the rinse nozzles. The correct pressure is ensured regardless of the water inlet pressure and temperature.

## HR - ENERGY RECOVERY

The ENERGY RECOVERY system uses the heat produced by the machine to preheat the inlet cold water (8-15 °C). This is an immediate saving on energy costs. Additionally, an optimal temperature in the dishwashing area is achieved as the air is no more affected by steam and humidity.

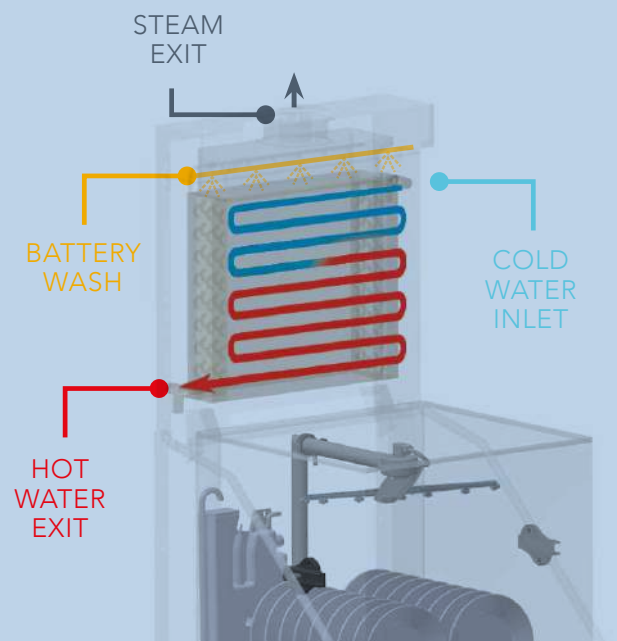

# HOOD 130 LUX

LATEST GENERATION  
HOOD-TYPE DISHWASHERS

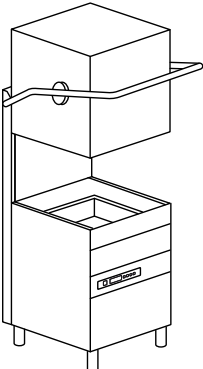
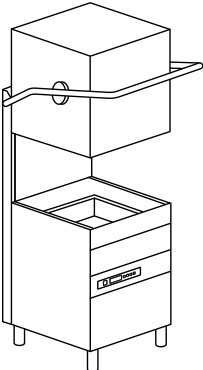
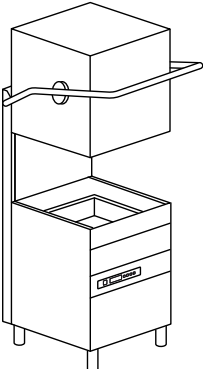
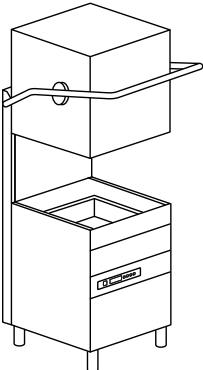
Model	Voltage	Capacity	Dimensions	Code	
<b>HOOD 130 LUX</b> ELECTRONIC 4 PROGRAMS					
	<p>RACK EQUIPMENT</p> <ul style="list-style-type: none"> <li>2 X C40</li> <li>1 X C44</li> <li>2 X 15060</li> </ul>	<p>400 V 3N ~ 50 Hz 10,5 kW</p>	<p>∅ 410</p> <p>500x500</p>	<p>720x735x 1445/1880 H 115 kg</p> <p>GN 1/1 X</p> <p>530x325x25 H</p>	<p><b>HOOD 130 LUX</b></p> <p><b>HOOD 130 LUX DA</b></p>
<b>HOOD 130 LUX H+</b> ELECTRONIC 4 PROGRAMS					
	<p>RACK EQUIPMENT</p> <ul style="list-style-type: none"> <li>2 X C40</li> <li>1 X C44</li> <li>2 X 15060</li> </ul>	<p>400 V 3N ~ 50 Hz 10,5 kW</p>	<p>∅ 410</p> <p>500x500</p>	<p>720x735x 1445/1880 H 115 kg</p> <p>GN 1/1 X</p> <p>530x325x25 H</p>	<p><b>HOOD 130 LUX H+</b></p> <p><b>HOOD 130 LUX DA H+</b></p>
<b>HOOD 130 LUX LIFT</b> ELECTRONIC 4 PROGRAMS					
	<p>RACK EQUIPMENT</p> <ul style="list-style-type: none"> <li>2 X C40</li> <li>1 X C44</li> <li>2 X 15060</li> </ul>	<p>400 V 3N ~ 50 Hz 10,5 kW</p>	<p>∅ 410</p> <p>500x500</p>	<p>720x735x 1445/1880 H 119 kg</p> <p>GN 1/1 X</p> <p>530x325x25 H</p>	<p><b>HOOD 130 LUX LIFT</b></p> <p><b>HOOD 130 LUX LIFT DA</b></p>
<b>HOOD 130 LUX LIFT H+</b> ELECTRONIC 4 PROGRAMS					
	<p>RACK EQUIPMENT</p> <ul style="list-style-type: none"> <li>2 X C40</li> <li>1 X C44</li> <li>2 X 15060</li> </ul>	<p>400 V 3N ~ 50 Hz 10,5 kW</p>	<p>∅ 410</p> <p>500x500</p>	<p>720x735x 1445/1880 H 119 kg</p> <p>GN 1/1 X</p> <p>530x325x25 H</p>	<p><b>HOOD 130 LUX LIFT H+</b></p> <p><b>HOOD 130 LUX LIFT DA H+</b></p>

Model	Voltage	Capacity	Dimensions	Code
<b>HOOD 130 LUX PLUS H+ ELECTRONIC 6 PROGRAMS</b>				
	<p><b>A<sub>0</sub>=30</b> <b>HYGIENE +</b></p> <p>RACK EQUIPMENT</p> <p>2 X C40 1 X C44 2 X 15060</p>	<p>400 V 3N ~ 50 Hz 10,5 kW</p>	<p>∅ 410</p> <p>500x500</p>	<p>720x735x 1445/1880 H 115 kg</p> <p><b>HOOD 130 LUX PLUS H+</b></p>
				<p>GN 1/1</p> <p>530x325x25 H</p> <p><b>HOOD 130 LUX PLUS DA H+</b></p>
<b>HOOD 130 LUX PLUS HR H+ ELECTRONIC 6 PROGRAMS - HR: HEAT RECOVERY</b>				
	<p><b>A<sub>0</sub>=30</b> <b>HYGIENE +</b></p> <p>RACK EQUIPMENT</p> <p>2 X C40 1 X C44 2 X 15060</p>	<p>400 V 3N ~ 50 Hz 10,5 kW</p> <p>HR: Cold water supply</p>	<p>∅ 410</p> <p>500x500</p>	<p>720x735x 2095 H 145 kg</p> <p><b>HOOD 130 LUX PLUS HR H+</b></p>
				<p>GN 1/1</p> <p>530x325x25 H</p> <p><b>HOOD 130 LUX PLUS HR DA H+</b></p>
<b>HOOD 130 LUX PLUS LIFT H+ ELECTRONIC 6 PROGRAMS</b>				
	<p><b>A<sub>0</sub>=30</b> <b>HYGIENE +</b></p> <p>RACK EQUIPMENT</p> <p>2 X C40 1 X C44 2 X 15060</p>	<p>400 V 3N ~ 50 Hz 10,5 kW</p>	<p>∅ 410</p> <p>500x500</p>	<p>720x735x 1445/1880 H 115 kg</p> <p><b>HOOD 130 LUX PLUS LIFT H+</b></p>
				<p>GN 1/1</p> <p>530x325x25 H</p> <p><b>HOOD 130 LUX PLUS LIFT DA H+</b></p>
<b>HOOD 130 LUX PLUS HR LIFT H+ ELECTRONIC 6 PROGRAMS - HR: HEAT RECOVERY</b>				
	<p><b>A<sub>0</sub>=30</b> <b>HYGIENE +</b></p> <p>RACK EQUIPMENT</p> <p>2 X C40 1 X C44 2 X 15060</p>	<p>400 V 3N ~ 50 Hz 10,5 kW</p> <p>HR: Cold water supply</p>	<p>∅ 410</p> <p>500x500</p>	<p>720x735x 2095 H 145 kg</p> <p><b>HOOD 130 LUX PLUS HR LIFT H+</b></p>
				<p>GN 1/1</p> <p>530x325x25 H</p> <p><b>HOOD 130 LUX PLUS HR LIFT DA H+</b></p>

## OPTIONS

Model	380-415 V	220-240 V	380-415 V	440 V	60 Hz	RO	XP	PS	DDE	DB
	3N 50 Hz	3 50 Hz	3 50 Hz	3 60 Hz		Osmosis Connection	Extra Power	Drain Pump	Detergent Dispenser	Rinse-Aid Dispenser
<b>HOOD 130 LUX</b>	●	□	€	€	€	----	€	€	●	●
<b>HOOD 130 LUX DA</b>	●	□	€	€	€	----	€	€	●	●
<b>HOOD 130 LUX H+</b>	●	□	€	€	€	----	€	€	●	●
<b>HOOD 130 LUX DA H+</b>	●	□	€	€	€	----	€	€	●	●
<b>HOOD 130 LUX LIFT</b>	●	□	€	€	€	----	€	€	●	●
<b>HOOD 130 LUX LIFT DA</b>	●	□	€	€	€	----	€	€	●	●
<b>HOOD 130 LUX LIFT H+</b>	●	□	€	€	€	----	€	€	●	●
<b>HOOD 130 LUX LIFT DA H+</b>	●	□	€	€	€	----	€	€	●	●
<b>HOOD 130 LUX PLUS H+</b>	●	□	€	€	€	□	€	€	●	----
<b>HOOD 130 LUX PLUS DA H+</b>	●	□	€	€	€	----	€	€	●	----
<b>HOOD 130 LUX PLUS HR H+</b>	●	□	€	€	€	□	€	€	●	----
<b>HOOD 130 LUX PLUS HR DA H+</b>	●	□	€	€	€	----	€	€	●	----
<b>HOOD 130 LUX PLUS LIFT H+</b>	●	□	€	€	€	□	€	€	●	----
<b>HOOD 130 LUX PLUS LIFT DA H+</b>	●	□	€	€	€	----	€	€	●	----
<b>HOOD 130 LUX PLUS HR LIFT H+</b>	●	□	€	€	€	□	€	€	●	----
<b>HOOD 130 LUX PLUS HR LIFT DA H+</b>	●	□	€	€	€	----	€	€	●	----

● Standard

□ Upon request

---- Not available

**DA** Built-in automatic water softener

**HR** Available in case of osmotic water supply, if the electrical conductivity is higher than 200 microsiemens

**LIFT** Automatic hood lift at the end of the cycle

**PLUS** Rinse with constant temperature and stabilized consumption

**H+** 2 cycles of 630 and 180 seconds with high temperatures, reaching up to 70 °C for washing and 90°C for rinsing

**PS** Not available with 380-415 V 3 50 Hz and 440 V 3 60 Hz (PLUS models)

EAC label upon request

Water supply 55 °C (not on HR version)



Model	DBE	BT	WRAS	DVGW	CONN.	PAP	ID	DF	FLOAT	CONTROL
	Peristaltic Rinse-Aid Disp.	Break tank	Wras	DVGW	Connectivity (HACCP)	Booster pump	Double Skin	Surface Filters Kit	Probes Lack det. and rinse aid	Substitute remote control panel
<b>HOOD 130 LUX</b>	€	€	€	€	€	€	●	●	€	----
<b>HOOD 130 LUX DA</b>	€	----	€	€	€	€	●	●	€	----
<b>HOOD 130 LUX H+</b>	€	€	€	€	€	€	●	●	€	----
<b>HOOD 130 LUX DA H+</b>	€	----	€	€	€	€	●	●	€	----
<b>HOOD 130 LUX LIFT</b>	€	€	€	€	€	----	●	●	€	----
<b>HOOD 130 LUX LIFT DA</b>	€	----	€	€	€	----	●	●	€	----
<b>HOOD 130 LUX LIFT H+</b>	€	€	€	€	€	----	●	●	€	----
<b>HOOD 130 LUX LIFT DA H+</b>	€	----	€	€	€	----	●	●	€	----
<b>HOOD 130 LUX PLUS H+</b>	●	●	€	€	€	●	●	●	€	€
<b>HOOD 130 LUX PLUS DA H+</b>	●	----	----	----	€	●	●	●	€	€
<b>HOOD 130 LUX PLUS HR H+</b>	●	●	----	----	€	●	●	●	€	€
<b>HOOD 130 LUX PLUS HR DA H+</b>	●	----	----	----	€	●	●	●	€	€
<b>HOOD 130 LUX PLUS LIFT H+</b>	●	●	€	€	€	●	●	●	€	€
<b>HOOD 130 LUX PLUS LIFT DA H+</b>	●	----	----	----	€	●	●	●	€	€
<b>HOOD 130 LUX PLUS HR LIFT H+</b>	●	●	----	----	€	●	●	●	€	€
<b>HOOD 130 LUX PLUS HR LIFT DA H+</b>	●	----	----	----	€	●	●	●	€	€







**XP** In case of cold water supply for rinse 8 °C 55 °C, and without any heat recovery, the extra power option is mandatory. + 3000 W with standard voltage only, for other voltages please contact us. In case of cold water supply for rinse 8-15 °C, We recommend the heat recovery option, if available on the selected model

**BT-WRAS-DVGW** Booster pump included

**DVGW** Components prescribed by DVGW on request (check option compatibility with the manufacturer)

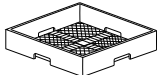
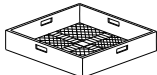
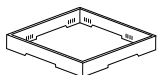
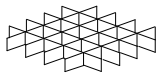
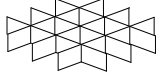
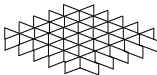
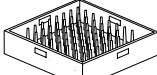
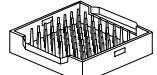
**CONNECTIVITY** Includes HACCP option. 10 year plan

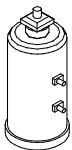
Option compatibility to be confirmed by the manufacturer after verification

	Description	Capacity	Dimensions	Code	
	SLOPED GLASS BASKET	Ø 100 max	500x500x200 H	<b>C 26</b>	
	REUSABLE CUP BASKET	5x5 Glass 30 < Ø < 90 mm H max 185 mm	500x500x235 H	<b>C 135</b> 	
	NARROW MESH CUTLERY BASKET		500x500x106 H	<b>C 41</b>	
	LARGE MESH BASKET	For glasses	500x500x105 H	<b>C 44</b>	
	HOLDER FOR GLASS SUPPORT	For glass support (C112-C113-C114)	500x500x50 H	<b>C 111</b>	
	GLASS SUPPORT	5x5 Glass Ø 87 mm (C111)	500x500x50 H	<b>C 112</b>	
	GLASS SUPPORT	4x4 Glass Ø 110 mm (C111)	500x500x50 H	<b>C 113</b>	
	GLASS SUPPORT	6x6 Glass Ø 72 mm (C111)	500x500x50 H	<b>C 114</b>	
	PLATE BASKET	18 plates	500x500x105 H	<b>C 40</b>	
	GASTRONORM TRAYS BASKET	6 pcs, max. depth 25 mm	500x500x105 H	<b>C 43/B</b>	
	CUTLERY BASKET		Ø 120x120 H	<b>15060</b>	
	WATER SOFTENER	12 l	Ø 200x500 H	<b>DEP 12</b>	
	AUTOMATIC WATER SOFTENER	12 l (max 800 l)	315x510x685 H	<b>DEP 12-AUT</b>	

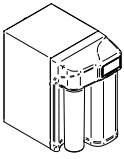
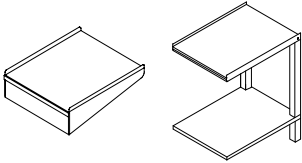
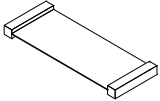
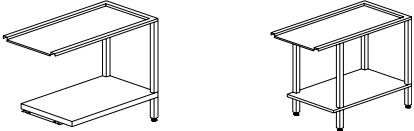
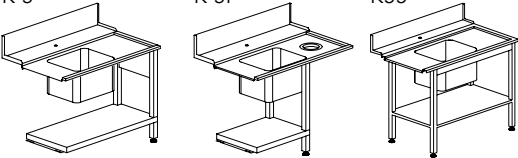
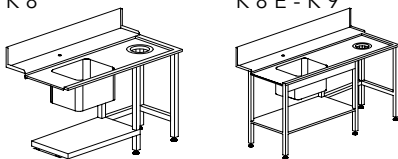
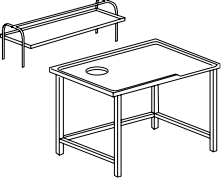
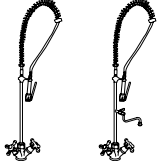
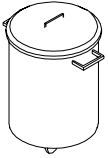
	Description	Capacity	Dimensions	Code	
	OSMOSIS FOR PLUS MODELS	230 V 50 Hz - 250 W 5° C - 30° C Flow rate 240 l/h Not suitable for machine with integrated water softener Special basket dotation	270x411x451 H 18 Kg	<b>K OS240</b>	
	SHELF  TABLE	Only for exit	600x510  650x510x860 H	<b>K 2ME</b>  <b>K 4/65</b>	
	HOOD CONNECTION SHELF			<b>KIT DUO</b>	
	K 4/70 B - K 4/120 B  K 4B	TABLE	700x590x860 H 1200x590x860 H 1200x590x860 H	<b>K 4/70B</b> <b>K 4/120B</b> <b>K 4B</b>	
	K 5 K 5F K 55	Sink 500x400x270 H	1200x730x860 H 1200x730x860 H 1200x730x860 H	<b>K 5</b> <b>K 5F</b> <b>K 55</b>	
	K 8 K 8E - K 9	Sink 500x400x270 H	1500x730x860 H 1500x730x860 H 1800x730x860 H	<b>K 8</b> <b>K 8E</b> <b>K 9</b>	
	SHELF  GRADING TABLE WITH RUBBER RING	Waste hole and special dimensions upon request	1515x620x660 H 2315x620x660 H 1600x1000x850 H 2400x1000x850 H	<b>K 7M16*</b> <b>K 7M24*</b> <b>K 7A/1600*</b> <b>K 7A/2400*</b>	
	FLEXIBLE SHOWER complete with mixing group and lever tap, to be fixed to the wall  FLEXIBLE SHOWER complete with mixing group and lever tap, to be fixed to the wall and intermediate tap		1000 H  1000 H	<b>K 1</b>  <b>K 1HR</b>	
	STAINLESS STEEL WASTE BIN	Basic model  With wheels  With wheels and pedal board	Ø 400x570 H Ø 400x570 H Ø 400x570 H	<b>K 7/1</b>  <b>K 7/2</b>  <b>K 7/3</b>	

\* Wooden cage +2% minimum + €  
Special dimensions for tables upon request  
Tables shown in right-to-left version

# HOOD 140 PREMIUM

CONNECTED HOOD-TYPE DISHWASHERS  
WITH CLEAN WATER TECHNOLOGY



We simply combined the highest specs and ultimate new technology to the time-tested name and features. HOOD 140 PREMIUM is our answer to the new high standards of hygiene and cleanliness of the worldwide market, keeping our renowned low operating costs thanks to the OPTIMAL RINSE system. Our HYGIENE+ cycles ( $A_0=60$ ) will guarantee to work safely by keeping top sanitation levels.

The settable additional cycle and the available self-monitoring technology and CONNECTIVITY

makes the HOOD 140 PREMIUM the range you have been expecting. An intuitive and interactive electronic panel will lead you through the new functions of your dishwasher. Its self-diagnosis system notifies any anomaly and clearly shows the different steps of the cycle and status of your dishwasher. 6 wash cycles (8 for the HYGIENE+ version) and the easy change of voltage make these machines incredibly versatile and easy to install.

$A_0=60$   
**HYGIENE+**

## HYGIENE+ SYSTEM

Our HYGIENE + models, with high temperatures and long cycles, ensure compliance with high levels of hygiene, nowadays more essential than ever for our personal health. We designed this range according to strict standards and parameters of thermal disinfection. All our HYGIENE + models obtain the  $A_0$  60 level, reducing pathogenic microorganisms and bacterial load according to the norm EN ISO 15883-1. Two cycles with high temperatures (180 and 630 seconds), reaching up to 75°C for washing and 90°C for rinsing, guarantee a full compliance with the disinfection principles.

## FEATURES

- Partial anticipated drain of waste water thanks to the standard drain-pump, waste wash water is partially drained before rinsing. At each cycle, wash water is cleaner, already warm and added with detergent and rinse-aid
- The innovative deep-formed tank with reduced volume allows significant savings on water, energy and chemicals also avoiding water stagnation
- Standard version: six wash cycles with partial drain of the wash water before rinsing
- Hygiene+ version: eight wash cycles, six with partial drain of the wash water before rinsing and two Hygiene+ programs
- Detergent and rinse-aid dosage setting, directly from the control panel
- Self-cleaning vertical pump
- Built-in peristaltic detergent and rinse-aid dispensers
- Double skin insulated hood
- PLUS system to grant a constant rinse temperature and pressure
- Water consumption and working time control system (PLUS versions)
- Break Tank system to prevent backflow contaminations in the piping network
- User-friendly multichrome START key
- Electronic control panel with TFT screen
- Language selection and menu personalization
- Self-diagnostic system, for users and service staff
- Self-cleaning cycle
- Soft Start wash pump
- Automatic built-in water softener version available on demand
- Option available remote control panel
- CONNECTIVITY remote control compliant with the HACCP norms (on request)



# HOOD 140 PREMIUM

CONNECTED HOOD-TYPE DISHWASHERS  
WITH CLEAN WATER TECHNOLOGY

## CONNECTIVITY 4.0 & APP

WHEREVER YOU ARE...

YOUR DISHWASHER, JUST A CLICK AWAY

You will be constantly connected to the machine to monitor the work phases, review any eventual alarm and configure remotely the operating parameters according to your needs. Compliant with HACCP norms. Thanks to our brand new App, you will have access to connected machines and all commercial and technical documentation.

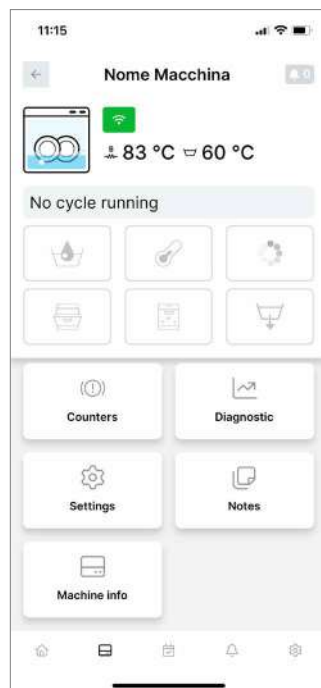

View all the working parameters and event records, working hours and any problem at any time.



In case of problem, the machine promptly alerts you. The technician can intervene remotely to solve the problem or anticipate the needed parts for an on-site intervention.



A daily activity report is available with all the events related to the dishwasher in a detailed spreadsheet with HACCP data.



Our Connectivity system is a revolutionary device limiting and facilitating the eventual intervention of a technician who can anticipate the necessary parts to be replaced, saving time and money.

## NEW HIGH-TECH BACKLIT DISPLAY

This new intuitive technology with colored icons, combined with a handy multi-color START, make the machine simple and efficient to use. In addition, the introduction of the new 'customizable cycles' function allows the installer to easily change all parameters related to the wash phase, pause and rinse length and temperatures according to the user's needs. The LED display provides information on the current status of the machine and on ongoing events such as errors, anomalies, temperatures, cycle selection, cycle progression, lack of salt if water softener included and many other indicators depending on the options selected during the configuration phase.

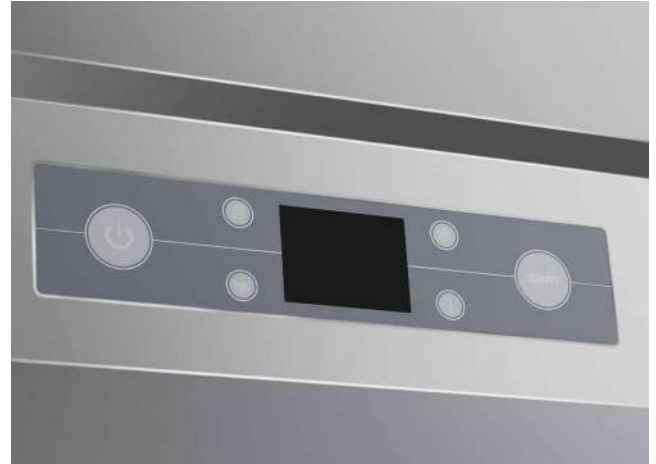

## IMPROVED LIFT SYSTEM:

**AUTOMATIC TWO-STEP HOOD LIFT AT THE END OF THE CYCLE**

The hydraulic system has been replaced by an electric motor. Its simplicity limits maintenance and the formation of limescale. The latter, freeing up space, allows to add more options to the LIFT models such as the integrated automatic softener.

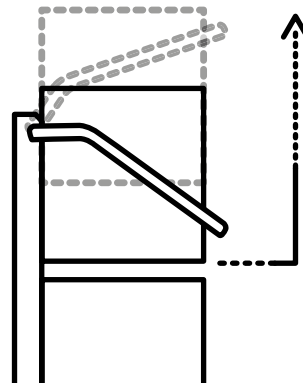





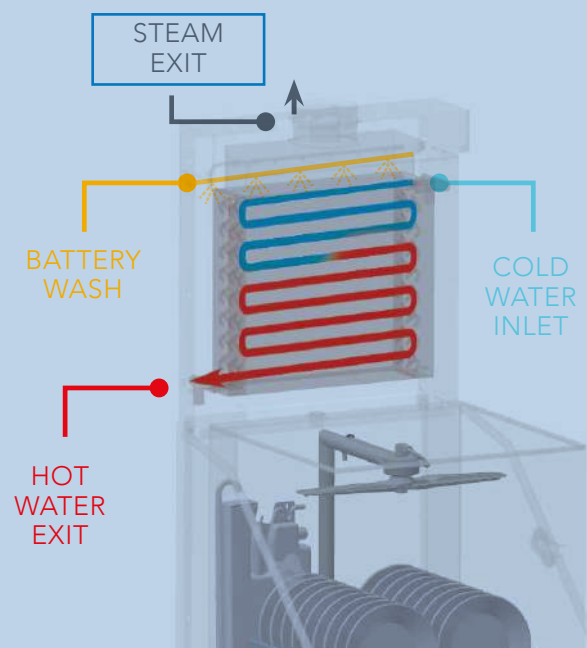





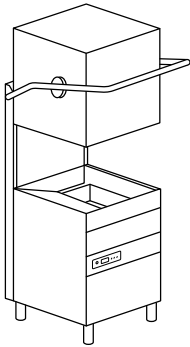



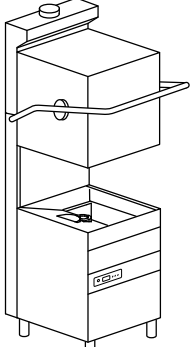

## HR - ENERGY RECOVERY

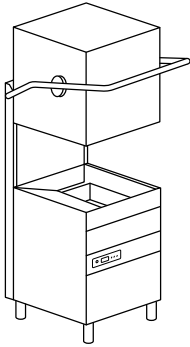
The ENERGY RECOVERY system uses the heat produced by the machine to preheat the inlet cold water (8-15 °C). This is an immediate saving on energy costs. Additionally, an optimal temperature in the dishwashing area is achieved as the air is no more affected by steam and humidity.

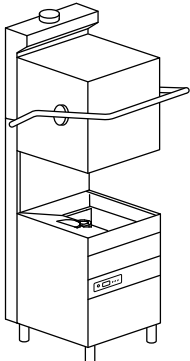

# HOOD 140 PREMIUM

CONNECTED HOOD-TYPE DISHWASHERS  
WITH CLEAN WATER TECHNOLOGY

Model		Voltage	Capacity	Dimensions	Code
<b>HOOD 140 PREMIUM</b> ELECTRONIC 6 PROGRAMS					
	<b>RACK EQUIPMENT</b> 2 X C40 1 X C44 2 X 15060	Multivoltage	 ø 410  500x500	720x735x 1445/1880 H 125 kg  530x325x25 H	<b>HOOD 140 PREMIUM</b>
		standard 400 V 3N 50 Hz (9,9 kW) -- 230 V 3 50 Hz (9,9 kW) -- 230 V 50 Hz (9,9 kW)			<b>HOOD 140 PREMIUM DA</b>
<b>HOOD 140 PREMIUM HR</b> ELECTRONIC 6 PROGRAMS - HR: HEAT RECOVERY					
	<b>RACK EQUIPMENT</b> 2 X C40 1 X C44 2 X 15060	Multivoltage	 ø 410  500x500	720x735x 2095 H 145 kg  530x325x25 H	<b>HOOD 140 PREMIUM HR</b>
		standard 400 V 3N 50 Hz (9,9 kW) -- 230 V 3 50 Hz (9,9 kW) -- 230 V 50 Hz (9,9 kW) HR: Cold water supply			<b>HOOD 140 PREMIUM HR DA</b>
<b>HOOD 140 PREMIUM LIFT</b> ELECTRONIC 6 PROGRAMS					
	<b>RACK EQUIPMENT</b> 2 X C40 1 X C44 2 X 15060	Multivoltage	 ø 410  500x500	720x735x 1445/1880 H 125 kg  530x325x25 H	<b>HOOD 140 PREMIUM LIFT</b>
		standard 400 V 3N 50 Hz (9,9 kW) -- 230 V 3 50 Hz (9,9 kW) -- 230 V 50 Hz (9,9 kW)			<b>HOOD 140 PREMIUM LIFT DA</b>
<b>HOOD 140 PREMIUM HR LIFT</b> ELECTRONIC 6 PROGRAMS - HR: HEAT RECOVERY					
	<b>RACK EQUIPMENT</b> 2 X C40 1 X C44 2 X 15060	Multivoltage	 ø 410  500x500	720x735x 1445/1880 H 125 kg  530x325x25 H	<b>HOOD 140 PREMIUM HR LIFT</b>
		standard 400 V 3N 50 Hz (9,9 kW) -- 230 V 3 50 Hz (9,9 kW) -- 230 V 50 Hz (9,9 kW) HR: Cold water supply			<b>HOOD 140 PREMIUM HR LIFT DA</b>

**X** With special basket to be ordered



Model	Voltage	Capacity	Dimensions	Code
<b>HOOD 140 PREMIUM H+</b> ELECTRONIC 8 PROGRAMS				
<p><b>RACK EQUIPMENT</b></p> <p>2 X C40 1 X C44 2 X 15060</p> <p><b>A<sub>0</sub>=60 HYGIENE +</b></p>	Multivoltage			
	standard 400 V 3N 50 Hz (9,9 kW)	 ø 410	720x735x 1445/1880 H 125 kg	<b>HOOD 140 PREMIUM H+</b>
	230 V 3 50 Hz (9,9 kW)	 500x500	 530x325x25 H	<b>HOOD 140 PREMIUM DA H+</b>
	230 V 50 Hz (9,9 kW)			
<b>HOOD 140 PREMIUM HR H+</b> ELECTRONIC 8 PROGRAMS - HR: HEAT RECOVERY				
<p><b>RACK EQUIPMENT</b></p> <p>2 X C40 1 X C44 2 X 15060</p> <p><b>A<sub>0</sub>=60 HYGIENE +</b></p>	Multivoltage			
	standard 400 V 3N 50 Hz (9,9 kW)	 ø 410	720x735x 2095 H 145 kg	<b>HOOD 140 PREMIUM HR H+</b>
	230 V 3 50 Hz (9,9 kW)	 500x500	 530x325x25 H	<b>HOOD 140 PREMIUM HR DA H+</b>
	230 V 50 Hz (9,9 kW)			
	HR: Cold water supply			
<b>HOOD 140 PREMIUM LIFT H+</b> ELECTRONIC 8 PROGRAMS				
<p><b>RACK EQUIPMENT</b></p> <p>2 X C40 1 X C44 2 X 15060</p> <p><b>A<sub>0</sub>=60 HYGIENE +</b></p>	Multivoltage			
	standard 400 V 3N 50 Hz (9,9 kW)	 ø 410	720x735x 2095 H 145 kg	<b>HOOD 140 PREMIUM LIFT H+</b>
	230 V 3 50 Hz (9,9 kW)	 500x500	 530x325x25 H	<b>HOOD 140 PREMIUM LIFT DA H+</b>
	230 V 50 Hz (9,9 kW)			
<b>HOOD 140 PREMIUM HR LIFT H+</b> ELECTRONIC 8 PROGRAMS - HR: HEAT RECOVERY				
<p><b>RACK EQUIPMENT</b></p> <p>2 X C40 1 X C44 2 X 15060</p> <p><b>A<sub>0</sub>=60 HYGIENE +</b></p>	Multivoltage			
	standard 400 V 3N 50 Hz (9,9 kW)	 ø 410	720x735x 2095 H 145 kg	<b>HOOD 140 PREMIUM HR LIFT H+</b>
	230 V 3 50 Hz (9,9 kW)	 500x500	 530x325x25 H	<b>HOOD 140 PREMIUM HR LIFT DA H+</b>
	230 V 50 Hz (9,9 kW)			
	HR: Cold water supply			

**A<sub>0</sub>=60** Special programs complying with A<sub>0</sub>=60 on the scale of thermo-disinfection according to the norm EN ISO 15883-1. All our Hygiene+ models reach the A<sub>0</sub> 60 level defining the minimum reduction level of pathogenic microorganisms and bacterial load. In addition, our Plus Rinsing System guarantees a perfect rinse with steady temperature and water pressure for optimum hygienic results

## OPTIONS

Model	220-240 V 50 Hz	380-415 V 3N 50 Hz	220-240 V 3 50 Hz	60 Hz	CONTROL Additional remote control panel	RO Osmosis Connection	XP Extra Power	PS Drain Pump	DDE Deter- gent Dispen- ser	DBE Peristaltic Rinse-Aid Disp.
<b>HOOD 140 PREMIUM</b>	M	●	M	€	€	□	€	●	●	●
<b>HOOD 140 PREMIUM DA</b>	M	●	M	€	€	----	€	●	●	●
<b>HOOD 140 PREMIUM HR</b>	M	●	M	€	€	□	----	●	●	●
<b>HOOD 140 PREMIUM HR DA</b>	M	●	M	€	€	----	----	●	●	●
<b>HOOD 140 PREMIUM H+</b>	M	●	M	€	€	□	€	●	●	●
<b>HOOD 140 PREMIUM DA H+</b>	M	●	M	€	€	----	€	●	●	●
<b>HOOD 140 PREMIUM HR H+</b>	M	●	M	€	€	□	----	●	●	●
<b>HOOD 140 PREMIUM HR DA H+</b>	M	●	M	€	€	----	----	●	●	●
<b>HOOD 140 PREMIUM LIFT</b>	M	●	M	€	€	□	€	●	●	●
<b>HOOD 140 PREMIUM LIFT DA</b>	M	●	M	€	€	----	€	●	●	●
<b>HOOD 140 PREMIUM HR LIFT</b>	M	●	M	€	€	□	----	●	●	●
<b>HOOD 140 PREMIUM HR LIFT DA</b>	M	●	M	€	€	----	----	●	●	●
<b>HOOD 140 PREMIUM LIFT H+</b>	M	●	M	€	€	□	€	●	●	●
<b>HOOD 140 PREMIUM LIFT DA H+</b>	M	●	M	€	€	----	€	●	●	●
<b>HOOD 140 PREMIUM HR LIFT H+</b>	M	●	M	€	€	□	----	●	●	●
<b>HOOD 140 PREMIUM HR LIFT DA H+</b>	M	●	M	€	€	----	----	●	●	●

● Standard

□ Upon request

---- Not available

**M** Multivoltage

**DA** Built-in automatic water softener

**HR** Available in case of osmotic water supply, if the electrical conductivity is higher than 200 microsiemens





**H+ (HYGIENE+)** 2 cycles of 630 and 180 seconds with high temperatures, reaching up to 75 °C for washing and 90°C for rinsing



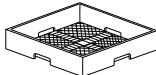
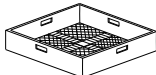
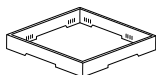
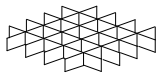
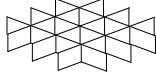
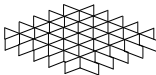
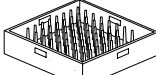
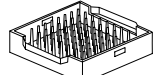

EAC label upon request

Water supply 55 °C (not on HR version)

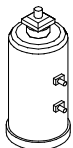
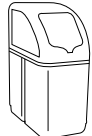
Model	TS	ST	BT	WRAS	DVGW	CONN.	PR	ID	DF	FLOAT
	Electronic timer + thermostop System	Soft start	Break tank	Wras	DVGW	Connectivity (HACCP)	Rinse pump	Double Skin	Surface Filters Kit	Probes Lack det. and rinse aid
<b>HOOD 140 PREMIUM</b>	●	●	●	€	€	€	●	●	●	€
<b>HOOD 140 PREMIUM DA</b>	●	●	----	----	----	€	●	●	●	€
<b>HOOD 140 PREMIUM HR</b>	●	●	●	----	----	€	●	●	●	€
<b>HOOD 140 PREMIUM HR DA</b>	●	●	----	----	----	€	●	●	●	€
<b>HOOD 140 PREMIUM H+</b>	●	●	●	€	€	€	●	●	●	€
<b>HOOD 140 PREMIUM DA H+</b>	●	●	----	----	----	€	●	●	●	€
<b>HOOD 140 PREMIUM HR H+</b>	●	●	●	----	----	€	●	●	●	€
<b>HOOD 140 PREMIUM HR DA H+</b>	●	●	----	----	----	€	●	●	●	€
<b>HOOD 140 PREMIUM LIFT</b>	●	●	●	€	€	€	●	●	●	€
<b>HOOD 140 PREMIUM LIFT DA</b>	●	●	----	----	----	€	●	●	●	€
<b>HOOD 140 PREMIUM HR LIFT</b>	●	●	●	----	----	€	●	●	●	€
<b>HOOD 140 PREMIUM HR LIFT DA</b>	●	●	----	----	----	€	●	●	●	€
<b>HOOD 140 PREMIUM LIFT H+</b>	●	●	●	€	€	€	●	●	●	€
<b>HOOD 140 PREMIUM LIFT DA H+</b>	●	●	----	----	----	€	●	●	●	€
<b>HOOD 140 PREMIUM HR LIFT H+</b>	●	●	●	----	----	€	●	●	●	€
<b>HOOD 140 PREMIUM HR LIFT DA H+</b>	●	●	----	----	----	€	●	●	●	€

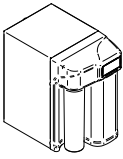
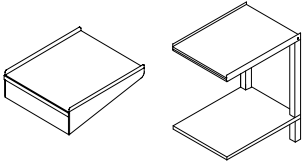
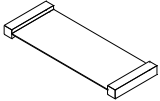
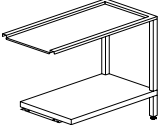
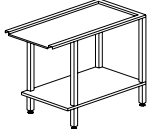
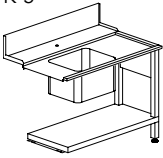
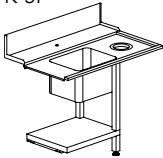
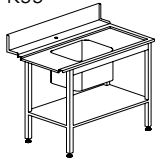
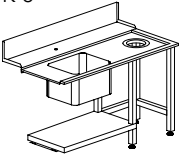
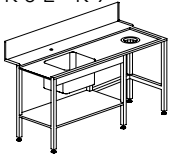
- SOFT START** Progressive start of the wash pump
  - XP** In case of cold water supply for rinse 8 °C 55 °C, and without any heat recovery, the extra power option is mandatory. + 3000 W with standard voltage only, for other voltages please contact us. In case of cold water supply for rinse 8-15 °C, We recommend the heat recovery option, if available on the selected model
  - BT - WRAS - DVGW** Booster pump included
  - DVGW** Components prescribed by DVGW on request (check option compatibility with the manufacturer)
  - CONNECTIVITY** Includes HACCP option. 10 year plan
  - LIFT** Automatic two-step hood lift at the end of the cycle
- Option compatibility to be confirmed by the manufacturer after verification

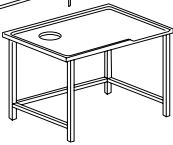
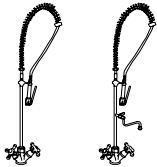
	Description	Capacity	Dimensions	Code
	SLOPED GLASS BASKET	Ø 100 max	500x500x200 H	<b>C 26</b>
	REUSABLE CUP BASKET	5x5 Glass 30 < Ø < 90 mm H max 185 mm	500x500x235 H	<b>C 135</b> 
	NARROW MESH CUTLERY BASKET		500x500x106 H	<b>C 41</b>
	LARGE MESH BASKET	For glasses	500x500x105 H	<b>C 44</b>
	HOLDER FOR GLASS SUPPORT	For glass support (C112-C113-C114)	500x500x50 H	<b>C 111</b>
	GLASS SUPPORT	5x5 Glass Ø 87 mm (C111)	500x500x50 H	<b>C 112</b>
	GLASS SUPPORT	4x4 Glass Ø 110 mm (C111)	500x500x50 H	<b>C 113</b>
	GLASS SUPPORT	6x6 Glass Ø 72 mm (C111)	500x500x50 H	<b>C 114</b>
	PLATE BASKET	18 plates	500x500x105 H	<b>C 40</b>
	GASTRONORM TRAYS BASKET	6 pcs, max. depth 25 mm	500x500x105 H	<b>C 43/B</b>
	CUTLERY BASKET		Ø 120x120 H	<b>15060</b>
	WATER SOFTENER	12 l	Ø 200x500 H	<b>DEP 12</b>
	AUTOMATIC WATER SOFTENER	12 l (max 800 l)	315x510x685 H	<b>DEP 12-AUT</b>

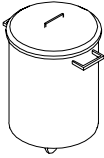
	Description	Capacity	Dimensions	Code	
	OSMOSIS	230 V 50 Hz - 250 W 5° C - 30° C Flow rate 240 l/h Not suitable for machine with integrated water softener Special basket dotation	270x411x451 H 18 Kg	<b>K OS240</b>	
	SHELF	Only for exit	600x510	<b>K 2ME</b>	
	TABLE		650x510x860 H	<b>K 4/65</b>	
	HOOD CONNECTION SHELF			<b>KIT DUO</b>	
			700x590x860 H 1200x590x860 H 1200x590x860 H	<b>K 4/70B</b> <b>K 4/120B</b> <b>K 4B</b>	
			Sink 500x400x270 H	1200x730x860 H 1200x730x860 H 1200x730x860 H	<b>K 5</b> <b>K 5F</b> <b>K 55</b>
			Sink 500x400x270 H	1500x730x860 H 1500x730x860 H 1800x730x860 H	<b>K 8</b> <b>K 8E</b> <b>K 9</b>
	SHELF		1515x620x660 H 2315x620x660 H	<b>K 7M16*</b> <b>K 7M24*</b>	
	GRADING TABLE WITH RUBBER RING	Waste hole and special dimensions upon request	1600x1000x850 H 2400x1000x850 H	<b>K 7A/1600*</b> <b>K 7A/2400*</b>	
	FLEXIBLE SHOWER complete with mixing group and lever tap, to be fixed to the wall		1000 H	<b>K 1</b>	
	FLEXIBLE SHOWER complete with mixing group and lever tap, to be fixed to the wall and intermediate tap		1000 H	<b>K 1HR</b>	
	STAINLESS STEEL WASTE BIN	Basic model With wheels With wheels and pedal board	Ø 400x570 H Ø 400x570 H Ø 400x570 H	<b>K 7/1</b> <b>K 7/2</b> <b>K 7/3</b>	

\* Wooden cage +2% minimum + €

Special dimensions for tables upon request

Tables shown in right-to-left version

# WASH & STORE

STOCK & WASH  
DISHWASHERS



WASH & STORE does the job for you in full comfort, thanks to its ultra-low-sound level and minimal heat loss in the room.

Less handling, less breakages, less repeated job, easy load/unload in full ergonomics. WASH & STORE takes care of it all. Dishes can be used immediately, after the cycles end, or can be left stocked in the machine, as in a shelf.

WASH & STORE can be installed in whatever room, as needing one third of space only, when compared to a traditional dishwashing system.

WASH & STORE consumes much less water i.e. much less chemicals. The electrical consumption is minimal and, thanks to the delayed Start, you can run it far from electrical peak times. This allows the reduction of power supply and, mainly, reduces the electricity bill.



## DOUBLE FACE VERSION

SAVES 65% ON OVERALL SPACE

WASH & STORE is available in two versions: a front-load one and a pass-through one -embedded in a wall- the second allowing a connection between two rooms, providing a net separation between loading area and clean area (kitchen) reducing even more the needed space.



## FEATURES

- Thermo-resistant independent glass doors
- Double-wall construction with thermo-acoustic insulation
- Chemicals dosing and monitoring station
- Cold-fog drying system
- Standard steam condenser
- Automatic, built-in water softener (not for HI TEMP version)
- AISI 316 wash-tank, insulated, with four independent self-cleaning pumps
- Low-sound level
- Can be installed in whatever room
- Consumes remarkably much less water i.e. much less chemicals
- Minimal electrical consumption and possibility to run the machine far from electrical peak times with the delayed Start, reducing the electricity bill
- Installing is easy and fast
- Due to the innovative drying concept, you can immediately pick and use the dishes after the cycle ends
- With the average costs level in Europe, the investment depreciation time ranges between 9 and 12 months depending on the machine's use
- According to our laboratory tests, we deem a life span between 12 to 15 years if the machine is used properly



1. Doors opening not interfering with equipment aside the machine
2. Thermo-resistant independant glass doors
3. Double-wall construction with thermo-acoustic insulation
4. Chemicals dosing and monitoring station, in a front load drawer
5. Cold-fog drying system

6. Standard steam condenser
7. Automatic, built-in water softener (no in HI TEMP version)
8. AISI 316 wash-tank, insulated, with 4 independent self-cleaning pumps
9. New system of wash and rinse arms, ensuring improved wash results





## FEATURES

WASH & STORE changes color at each cycle phase, displaying the actual working temperature. A water change at each cycle-stage, grants top hygiene levels. Thanks to the 9 wash-cycles available, just any washing needs are matched: from fragile crystal glasses, to heavily soiled pots.

## INNOVATIVE WASH ARMS

The WASH & STORE wash arms keep moving on behalf of your own arms, combining the advantages of the tunnel machines and those of the cycle-machines. With WASH & STORE you can divide the wash areas, according to your needs. Due to the innovative drying concept, you can immediately pick and use the dishes after the cycle ends if needed.

## INSTALLATION

Installing a WASH & STORE is easy and fast. Just connect the water circuit drainage and the supply cable and the machine is ready on duty.

No steam hoods or vent needed, no floor grids, no water treatment necessary: WASH & STORE is full optional.

Standard applications for the WASH & STORE are: wine-cellars, business restaurants up to 50 covers, family restaurants up to 75 covers, schools, pizzerias, hospital departments, retirement homes, clinics, Police stations and equivalent.



**-46%**

WATER  
CONSUMPTION



**-38%**

INSTALLED  
POWER



**-82%**

CHEMICAL  
CONSUMPTION







**-90%**

LABOUR

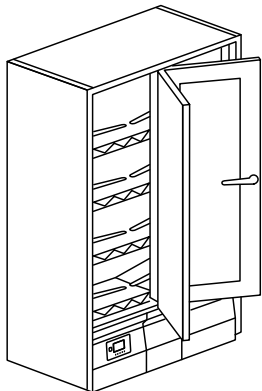
# WASH & STORE

STOCK & WASH  
DISHWASHERS

Model	Voltage	Capacity	Dimensions	Code
<b>WASH &amp; STORE</b>				
<b>PATENTED</b>				
	400 V 3N ~ 50 Hz 6,5 kW	 220 H - 320 H*   Ø 240 - Ø 330*   530x325x25 H*	1315x747x2043 H 390 kg  or 1315x747x1988 H 390 kg ( with wheels )	<b>WASH &amp; STORE</b>  <b>WASH &amp; STORE HI TEMP</b>





\* Upper level only

## OPTIONS

		DA	SC	PS		
Model	380-415 V 3N 50H	220-240 V 3 50 Hz	220-240 V 50 Hz	Water Softener	Steam Condenser	Drain Pump
<b>WASH &amp; STORE</b>	●	□	□	●	●	●
<b>WASH &amp; STORE HI TEMP</b>	●	□	□	----	●	●
<b>WASH &amp; STORE DOUBLE FACE</b>	●	□	□	●	●	●
<b>WASH &amp; STORE DOUBLE FACE HI TEMP</b>	●	□	□	----	●	●

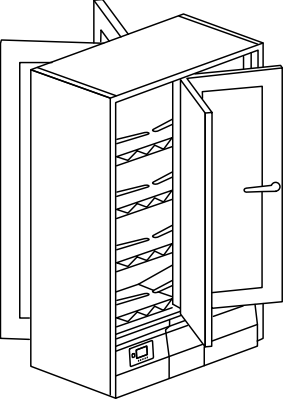
- Standard
- Upon request
- Not available

EAC label upon request







Model	Voltage	Capacity	Dimensions	Code
<b>WASH &amp; STORE DOUBLE FACE</b>				
<b>PATENTED</b>				
	400 V 3N ~ 50 Hz 6,5 kW	 220 H - 320 H*   Ø 240 - Ø 330*   530x325x25 H*	1315x810x2043 H 400 kg  or 1315x810x1988 H 400 kg ( with wheels )	<b>WASH &amp; STORE DOUBLE FACE</b>  <b>WASH &amp; STORE DOUBLE FACE HI TEMP</b>

	DDE	DB	D-SAN	FLOAT	ID	DR-F	R
Model	Detergent Dispenser	Rinse-Aid Dispenser	Sanitizer Dispenser	Probes Lack det. and rinse aid	Double Skin	Cold fog drying system	Wheels
<b>WASH &amp; STORE</b>	●	●	●	●	●	●	€
<b>WASH &amp; STORE HI TEMP</b>	●	●	●	●	●	●	€
<b>WASH &amp; STORE DOUBLE FACE</b>	●	●	●	●	●	●	€
<b>WASH &amp; STORE DOUBLE FACE HI TEMP</b>	●	●	●	●	●	●	€

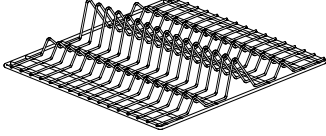

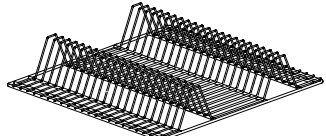

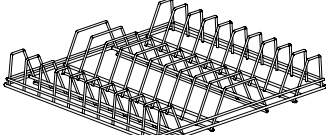

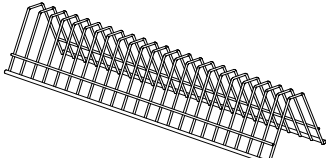
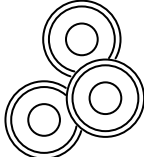
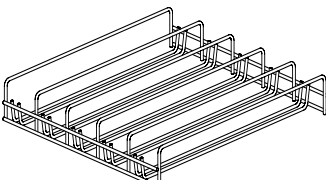
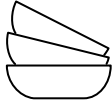

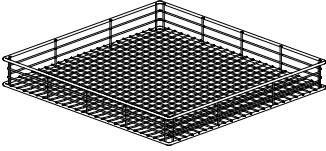

**WASH & STORE** With water softener, water supply max 45 °C - Water hardness < 20 °f

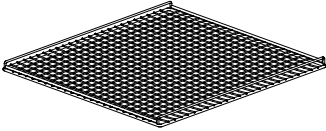
**WASH & STORE HI TEMP** Without water softener, water supply max 65 °C - Max water hardness 5 °f, if higher an external water softener is required

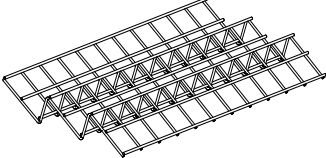
Option compatibility to be confirmed by the manufacturer after verification

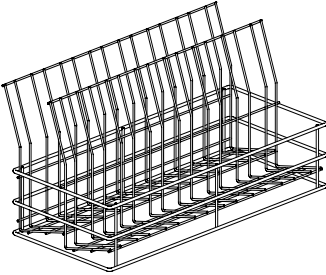
	Description	Capacity	Dimensions	Code
	RACK FOR PLATES AND TRAYS	30 pcs 15 pcs	 210 <math><\varnothing></math> 240 250 <math><\varnothing></math> 330* max depth 40	<b>590071</b>
		15 pcs	 530x325x25 H*	
	RACK FOR FLAT DISHES	42 pcs	 250x15 max depth 15	<b>590072</b>
	RACK FOR PLATES	20 pcs 10 pcs	 210 <math><\varnothing></math> 240 250 <math><\varnothing></math> 330* max depth 70	<b>590124</b>
		10 pcs	 530x325x25 H*	
	SAUCER SUPPORT in combination with 590074 or 590075	23 pcs	 $\varnothing < 240$	<b>590078</b>
	BOWLS SUPPORT in combination with 590074	8 pcs	 $\varnothing$ 235 depth 100	<b>590128</b>
		20 pcs	$\varnothing$ 110 depth 50	

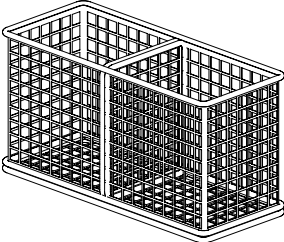
\* upper level only

	Description	Capacity	Dimensions	Code	
	RACK FOR MUGS AND LOW GLASSEST	25 pcs	 Ø 100	<b>590074</b>	
	RACK FOR MUGS AND LOW GLASSEST	25 pcs	 Ø 100	<b>590075</b>	
	CUPS SUPPORT for 590074 / 590075 in combination with 590074	24 pcs	 Ø < 55	<b>590076</b>	
	SUPPORT FOR TALL GLASSES in combination with 590075	8 pcs	 Ø 100	<b>590077</b>	
	CUTLERY SUPPORT in combination with 590074 or 590075	30 pcs		<b>590080</b>	



The RK COMPACT dishwashers line has been designed to satisfy the demand of medium and small restaurants. These machines combine com-

pact dimensions with high performances. We now introduce the new line with electromechanical panel to enhance the usability.

## CUSTOMIZABLE AND REVERSIBLE

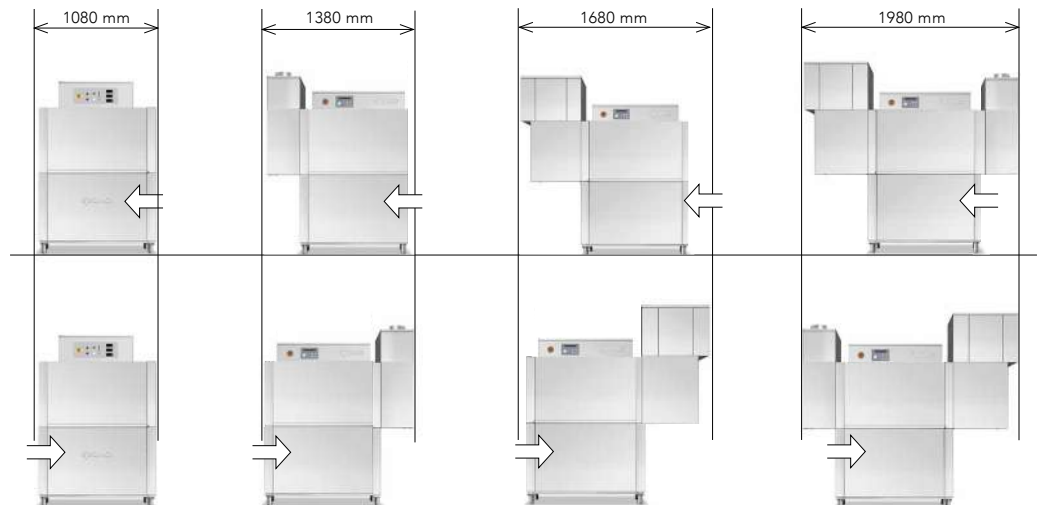

## FEATURES

- Sloped radial wash tanks to help emptying the tanks
- Self-cleaning vertical wash pumps, protected from electrical overloads
- Traction system with built-in clutch preventing derailment
- AISI 304 stainless steel boilers, fully insulated to reduce thermal losses
- Simple and intuitive touch control panel or electromechanical panel
- S/S wash and rinse arms. These are removable without using any tool
- S/S surface filters on every tank, easily removable without detaching wash arms
- Insulated double skin door, counterbalanced, equipped with anti-drop safety system
- DRIVE speed variator with 3 speeds on the electromechanical versions and 5 speeds on the electronic versions
- Autotimer in order to switch off the rack conveyor motor as well as other machine's options (electronic version)
- Economizers to allow operation only when the rack is detected on that specific area
- Pressure reducer, to stabilize the water pressure and grant an optimal final rinse
- Non-return valve to prevent the water backflow
- Linear or 90° arc drying module (Option)
- Sanitization system which includes the sanitizing product dispensers (Option for electronic version only)
- Heat recovery in case of cold water inlet (8-15 °C) (Option)

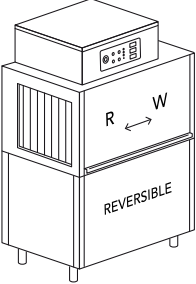
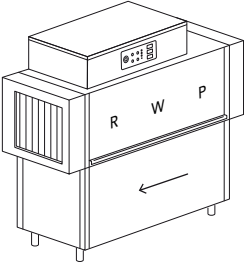
Model		Voltage	Capacity	Dimensions	Code
<b>RK 1010</b>	3 SPEEDS				
<b>IMPROVED</b>					
	<p>RACK EQUIPMENT</p> <ul style="list-style-type: none"> <li>1 X C40</li> <li>1 X C43</li> <li>1 X C44</li> <li>1 X C47</li> </ul>	<p>400 V 3N ~ 50 Hz 19,1 kW</p>	<p>Ø 450</p> <p>500x500</p> <p>66* - 100 racks / h</p>	<p>1080 x 715 1690/1900 H 210 kg</p> <p>GN 1/1</p> <p>530x325x25 H</p>	<b>RK 1010</b>
<b>RK 1640</b>	3 SPEEDS				
<b>IMPROVED</b>					
	<p>RACK EQUIPMENT</p> <ul style="list-style-type: none"> <li>1 X C40</li> <li>1 X C43</li> <li>1 X C44</li> <li>1 X C47</li> </ul>	<p>400 V 3N ~ 50 Hz 23,6 kW</p>	<p>Ø 450</p> <p>500x500</p> <p>86* - 150 racks / h</p>	<p>1880 x 715 1690/1900 H 270 kg</p> <p>GN 1/1</p> <p>530x325x25 H</p>	<b>RK 1640</b>







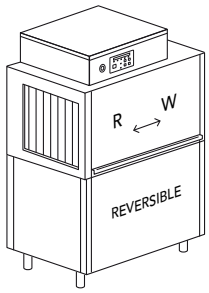

**P** Prewash

**W** Wash

**R** Single rinse

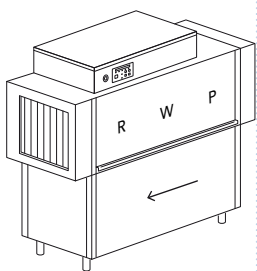
**\*** Productivity according to DIN SPEC 10534 regulation ( contact time )



Model	Voltage		Capacity	Dimensions	Code
<b>RK 1010 E</b>	ELECTRONIC 5 SPEEDS				
<i>IMPROVED</i>					
	<p>RACK EQUIPMENT</p> <ul style="list-style-type: none"> <li>1 X C40</li> <li>1 X C43</li> <li>1 X C44</li> <li>1 X C47</li> </ul> 	<p>400 V 3N ~ 50 Hz 19,1 kW</p>	<p>Ø 450</p>  <p>500x500</p> <p>66* - 100 racks / h</p>	<p>1080 x 715 1565/1900 H 210 kg</p>  <p>530x325x25 H</p>	<b>RK 1010 E</b>
<b>RK 1640 E</b>	ELECTRONIC 5 SPEEDS				
<i>IMPROVED</i>					
	<p>RACK EQUIPMENT</p> <ul style="list-style-type: none"> <li>1 X C40</li> <li>1 X C43</li> <li>1 X C44</li> <li>1 X C47</li> </ul> 	<p>400 V 3N ~ 50 Hz 23,6 kW</p>	<p>Ø 450</p>  <p>500x500</p> <p>86* - 150 racks / h</p>	<p>1880 x 715 1565/1900 H 270 kg</p>  <p>530x325x25 H</p>	<b>RK 1640 E</b>

## OPTIONS

Model	220-240 V 3 50 Hz	380-415 V 3N 50 Hz	60 Hz	XP Extra Power	PRE DOS Kromo disp. connections	DDE-GROUP Dispensers kit	DOS/S Dispenser with probe	Rinse econom.	Pressure reducer	High speed	DRIVE Smart drive	AUTOTIMER Autotimer	Soft Touch panel
<b>RK 1010</b>	€	●	+3%	€	●	€	€	●	●	----	●	----	----
<b>RK 1640</b>	€	●	+3%	€	●	€	€	●	●	----	●	----	----
<b>RK 1010 E</b>	€	●	+3%	€	●	€	€	●	●	€	●	●	●
<b>RK 1640 E</b>	€	●	+3%	€	●	€	€	●	●	----	●	●	●

● Standard

---- Not available

**E** Electronic panel

**KDRA924** Available only without KM22 - KM23 on entry

**KM22 - KM23** Available on entry or exit connections, one per layout

**DDE-GROUP** Both detergent (with probe) and rinse-aid dispensers included

**DOS/S** For detergent dispenser only

**HIGH SPEED** Extra power included. Hot water inlet 55°C

**AUTOTIMER** Functioning only when combined with KDR24, KDRA924, KSC5, KHR5

Water supply 55 °C - We recommend to install the machine in a well ventilated room, with a properly sized steam exhausting system

Construction according to UL-NSF standards upon request

EAC label upon request

Option compatibility to be confirmed by the manufacturer after verification

### AVAILABLE ARCS:

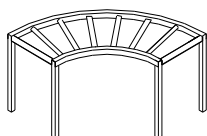

**K21**  
1300x1300x860 H  
90° roller arc with tank

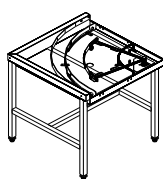

**KM22**  
850x850x885 H  
90° mechanized arc  
( clockwise/counter-clockwise )

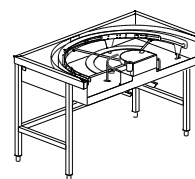

**KM23**  
850x1500x885 H  
180° mechanized arc  
( clockwise/counter-clockwise )

	BT	DVGW	DWI/T	DWI	PI	PAP	SAN	PAP-SAN	DIV	KSC5	KHR5	KDR24	KDRA924	K16AC
Model	Break tank	DVGW	Tank insulation	Thermoacoustic insulation	S/S pumps	Booster pump	Sanitization System	Booster Pump Sanitization	Price for division	Steam cond.	Heat recovery	Dryer	Dryer 90° arc	Splash guard
<b>RK 1010</b>	----	----	€	€	€	€	----	----	€	€	€	€	€	€
<b>RK 1640</b>	----	----	€	€	€	€	----	----	€	€	€	€	€	●
<b>RK 1010 E</b>	€	€	€	€	€	€	€	€	€	€	€	€	€	€
<b>RK 1640 E</b>	€	€	€	€	€	€	€	€	€	€	€	€	€	●

**BT** Booster pump included

**DVGW** Not available with heat recovery and steam condenser  
Components prescribed by DVGW on request (check option compatibility with the manufacturer)

**DWI - DWI/T** Recommended with KHR5

**PI** Available with 50 Hz frequency only

**SAN** Including dosing system for sanitizing product

**KHR5** With osmotic water supply and electrical conductivity lower than 200 microsiemens, it is mandatory to install a stainless steel heat exchanger

**XP** In case of cold water supply for rinse 8 °C 55 °C, and without any heat recovery, the extra power option is mandatory. In case of cold water supply for rinse 8-15 °C, We recommend the heat recovery option

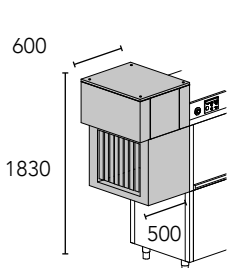

**KDR24**

4,5 kW

Dryer

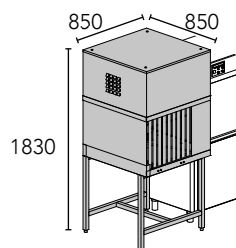

**KDRA924**

4,5 kW

Dryer with mechanized arc 90°  
to be used with original Kromo racks only

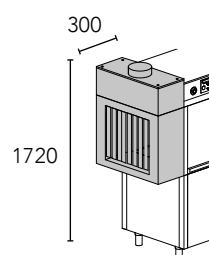

**KSC5**

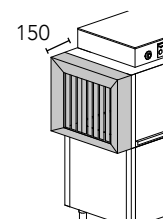

Steam condenser

Compact heat recovery

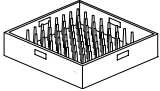
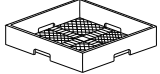
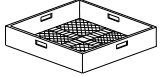
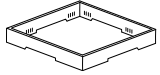
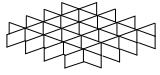
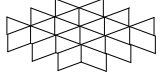
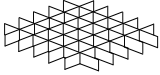
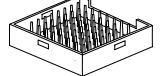

**K16AC**

Splash guard

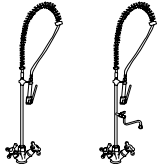
	Description	Capacity	Dimensions	Code	
	PLATE BASKET	18 plates	500x500x105 H	<b>C 40</b>	
	NARROW MESH CUTLERY BASKET		500x500x106 H	<b>C 41</b>	
	LARGE MESH BASKET	For glasses	500x500x105 H	<b>C 44</b>	
	HOLDER FOR GLASS SUPPORT	For glass support (C112-C113-C114)	500x500x50 H	<b>C 111</b>	
	GLASS SUPPORT	5x5 Glass Ø 87 mm (C111)	500x500x50 H	<b>C 112</b>	
	GLASS SUPPORT	4x4 Glass Ø 110 mm (C111)	500x500x50 H	<b>C 113</b>	
	GLASS SUPPORT	6x6 Glass Ø 72 mm (C111)	500x500x50 H	<b>C 114</b>	
	TRAYS BASKET	8 pcs, max. depth 25 mm	500x500x105 H	<b>C 43</b>	
	CUTLERY BASKET		490x180x140 H	<b>C 47</b>	
	FLEXIBLE SHOWER complete with mixing group and lever tap, to be fixed to the wall		1000 H	<b>K 1</b>	
	FLEXIBLE SHOWER complete with mixing group and lever tap, to be fixed to the wall and intermediate tap		1000 H	<b>K 1HR</b>	

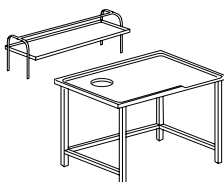
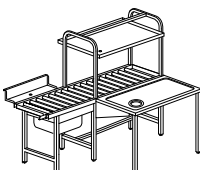
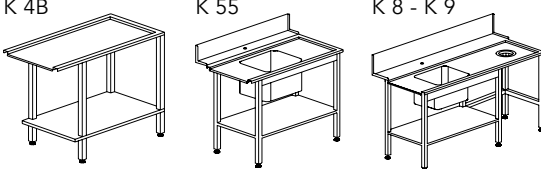
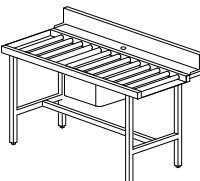
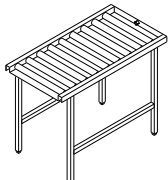
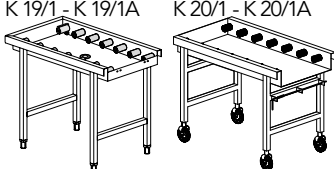
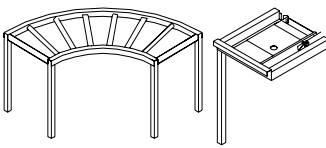
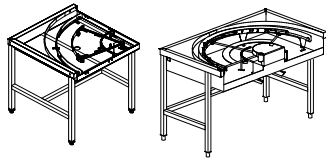
	Description	Capacity	Dimensions	Code
	SHELF		1515x620x660 H	<b>K 7M16*</b>
			2315x620x660 H	<b>K 7M24*</b>
	GRADING TABLE WITH RUBBER RING	Waste hole and special dimensions upon request	1600x1000x850 H	<b>K 7A/1600*</b>
			2400x1000x850 H	<b>K 7A/2400*</b>
	MECHANIZED GRADING TABLE With mechanized basket advancement system	1 waste hole	1800x1240 1525 H	<b>K M7/1800*</b>
		2 waste holes	2400x1240 1525 H	<b>K M7/2400*</b>
			1200x590x860 H	<b>K 4B</b>
			1200x730x860 H	<b>K 55</b>
		Standard rubber ring	1500x730x860 H	<b>K 8</b>
		Standard rubber ring	1800x730x860 H	<b>K 9</b>
	Sink 500x400x270 H	Sink 500x400x270 H		
	ROLLER TABLE + sink, right or left version		1600x730x860 H	<b>K 195</b>
	Sink 500x400x270 H			
	LINEAR ROLLER TABLE WITH TANK		1100x650x860 H	<b>K 19*</b>
			1600x650x860 H	<b>K 19/B*</b>
			2100x650x860 H	<b>K 19/C*</b>
		Option end microswitch		<b>K 18</b>
	LINEAR ROLLER TABLE WITH TANK complete with end microswitch	Not compatible with same references Not on 180° arcs	1100x650x860 H	<b>K 19/1</b>
			1600x650x860 H	<b>K 19/1A</b>
		To be connected to KM23 only and to dryer on 180°	1150x650x860 H	<b>K 20/1</b>
			1650x650x860 H	<b>K 20/1A</b>
	90°roller arc with tank (exit only with roller table)		1300x1300x860 H	<b>K 21*</b>
	ANGLE LOADING TABLE complete with basket pull-through system	Optional connection to prewash tables	700x610x820 H	<b>K 25</b>
	90° MECHANIZED ARC ( clockwise/counter-clockwise ) not available at the entry on K10 version	Available on entry or exit connections, one per layout.	850x850x885 H	<b>KM 22*</b>
	180° MECHANIZED ARC ( clockwise/counter-clockwise )	To be used with original KROMO racks only	850x1500x885 H	<b>KM 23*</b>

\* Wooden cage +2% minimum + € / Special dimensions for tables upon request / Tables shown in right-to-left version

We strongly recommend the presence of a roller table with end microswitch at the exit of our rack type machines for a correct operation



KROMO introduces RK UP with single rinse. This new range of rack conveyor dishwashers, thanks to the new single tank configuration, meets the DIN 10512 norm with a contact of 90 seconds.

Combined with numerous accessories, this new line of RK UP offers personalized solutions for all demands.





## FEATURES

### STANDARD

- Double-skin, insulated and counterbalanced doors, equipped with anti-drop safety system
- Ergonomic handles
- Thermo barrier system for comfort in use
- Acid proof AISI 316 stainless steel radial wash tanks
- CLEAN+ filters
- Self-cleaning vertical wash pumps, protected from electrical overloads
- Wash arms ALL-IN-1
- CPF System
- Side traction system with built-in clutch
- DRIVE speed variator with 5 speeds
- Use economizer
- Acid proof AISI 316 stainless steel boilers, fully insulated to reduce thermal loss
- Autotimer switching off the rack conveyor motor and all electrical options after a preset lapse of inactivity
- Single rinse R with limited consumptions
- Control panel with IPX5 membrane keyboard

### OPTIONS

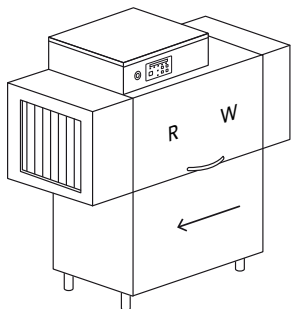
- Linear and 90°/180° corner drying modules, power 4,5 kW or 9 kW (double skin dryer available for linear models only)
- Steam condenser (KSC10)
- Two models of heat recovery to be chosen according to the type of machine (compact or with integrated heat pump)
- Detergent dispenser with probe or dispensers kit
- Booster pump
- Hydraulic security system Break Tank
- Extra power for the boiler
- Thermal and acoustic insulation
- Stainless steel pumps
- Centralized drain 1-DRAIN
- Delivery in 2 or more parts to facilitate handling
- Machine sanitization also with dedicated booster pump

Model	Voltage	Capacity	Dimensions	Code
<b>RK 1020 E</b> 5 SPEEDS				
<b>IMPROVED</b>				
	400 V 3N ~ 50 Hz 21,9 kW		1900x805x 1830/2120 H 300 kg  GN 1/1 530x325x25 H	<b>RK 1020 E</b>



- P** Prewash
- W** Wash
- R** Single rinse

## OPTIONS

Model	220-240 V 3 50 Hz	380-415 V 3N 50 Hz	60 Hz	PRE DOS Kromo disp. connections	DDE-GROUP Dispensers kit	DOS/S Dispenser with probe	SAN Sanitization System	PAP-SAN Booster Pump Sanitiz.	DWI Thermoacoustic insulation	PAP Booster pump
<b>RK 1020 E</b>	€	●	+3%	●	€	€	€	€	€	€
<b>RK 1420 E</b>	€	●	+3%	●	€	€	€	€	€	€

- Standard
- Not available
- E** Settable electronic panel
- DDE-GROUP** Both detergent (with probe) and rinse-aid dispensers included
- DOS/S** For detergent dispenser only
- SAN** Including dosing system for sanitizing product
- DWI** Insulation option for the tunnel only, dryer excluded. Shelf dryer can be insulated upon request. Recommended with KHR10 – KHRP40
- DIV** Only splash guards removable
- XP** In case of cold water supply for rinse 8 °C 55 °C, and without any heat recovery, the extra power option is mandatory



Model	Voltage	Capacity	Dimensions	Code
<b>RK 1420 E</b> 5 SPEEDS <i>IMPROVED</i>	400 V 3N ~ 50 Hz 19,7 kW	 Ø 450  500x500 93 - 144 racks / h 119* racks / h	2100x805x 1830/2120 H 310 kg  530x325x25 H	<b>RK 1420 E</b>

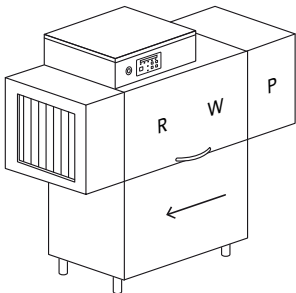

**RACK EQUIPMENT**  
 1 X C40  
 1 X C43  
 1 X C44  
 1 X C47

\* Productivity according to DIN SPEC 10512 regulation ( contact time )

	DRIVE	AUTOTIMER	BT	DVGW	XP	DIV	PI	1-DRAIN
Model	Smart drive	Autotimer	Break tank	DVGW	Extra Power	Price for division	S/S pumps	Centralized Drain
<b>RK 1020 E</b>	●	●	€	€	€	€	€	●
<b>RK 1420 E</b>	●	●	€	€	€	€	€	●

- PI** Available with 50 Hz frequency only
- DVGW** Not available with heat recovery and steam condenser
- BT** Booster pump included
- DRIVE** Check voltage compatibility

With osmotic water supply and electrical conductivity lower than 200 microsiemens, it is mandatory to install a stainless steel heat exchanger

We recommend to install the machine in a well ventilated room, with a properly sized steam exhausting system

Peak-cut connect upon request

Water supply 55 °C

EAC label upon request

Option compatibility to be confirmed by the manufacturer after verification

## OPTIONS

	KSC10	KHR10	KHRP40	KDR64	KDR69	KDR94
Model	Steam cond.	Heat recovery	Heat recovery	Dryer + 400 mm / 4,5 kW	Dryer + 400 mm / 9 kW	Dryer + 700 mm / 4,5 kW
<b>RK 1020 E</b>	€	€	€	€	€	€
<b>RK 1420 E</b>	€	€	----	€	€	€

- Standard
- Not available

**KHRP40** Available with 400 V 3N 50 Hz frequency only

**KHR10 - KHRP40** In case of cold water supply for rinse (8-15 °C), we recommend to install the heat recovery system optional. Extra power included

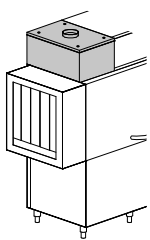

**KSC10**  
Steam condenser

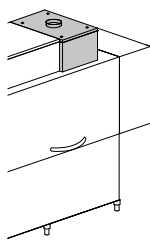

**KHR10**  
Compact heat recovery

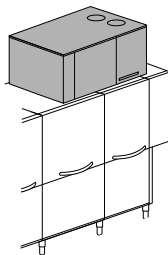

**KHRP40**  
Heat recovery with heat pump

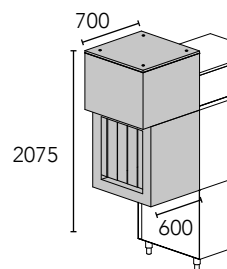

**KDR64** 4,5 kW Electric  
**KDR69** 9 kW Electric  
Dryer

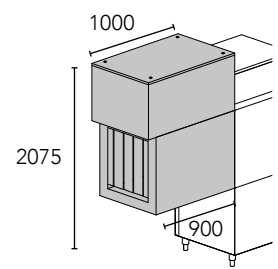

**KDR94** 4,5 kW Electric  
**KDR99** 9 kW Electric  
Dryer

	KDR99	KDRA94MC	KDRA99MC	KDRA184MC	KDRA189MC	ID
Model	Dryer + 700 mm / 9 kW	Mechanized dryer 90° arc 4,5 kW	Mechanized dryer 90° arc 9 kW	Mechanized dryer 180° arc 4,5 kW	Mechanized dryer 180° arc 9 kW	Double skin for dryer
<b>RK 1020 E</b>	€	€	€	€	€	€
<b>RK 1420 E</b>	€	€	€	€	€	€

**ID** Recommended for KDR69 - KDR99. Not available for corner dryers

**KM22 - KM23** Available on entry or exit connections, one per layout

**KDRA184MC - KDRA189MC** Mandatory division

**KDR64 - KDR94 - KDRA94MC - KDRA184MC** Verify feasibility with manufacturer

**KDRA94MC - KDRA99MC - KDRA184MC - KDRA189MC** Available only without KM22 - KM23 on entry

## AVAILABLE ARCS:

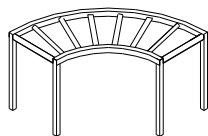

**K21**  
1300x1300x860 H  
90° roller arc with tank

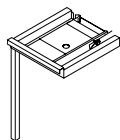

**K25**  
700x610x820 H  
Angle loading table complete  
with basket  
pull-through system

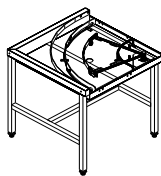

**KM22**  
850x850x885 H  
90° mechanized arc  
( clockwise/counter-clockwise )  
to be used with original Kromo racks  
only

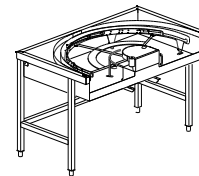

**KM23**  
850x1500x885 H  
180° mechanized arc  
( clockwise/counter-clockwise )  
to be used with original Kromo  
racks only

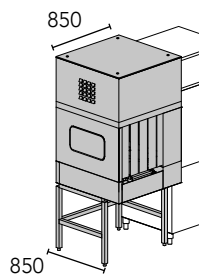

**KDRA94MC** 4,5 kW Electric  
**KDRA99MC** 9 kW Electric  
Dryer with mechanized arc 90° to be  
used with original Kromo racks only

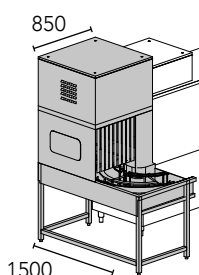

**KDRA184MC** 4,5 kW Electric  
**KDRA189MC** 9 kW Electric  
Dryer with mechanized arc 180° to be  
used with original Kromo racks only



KROMO presents the RK UP line of rack conveyor dishwashers with double rinse: a range of models with multiple accessories to offer tailor-made solutions for any customer needs.

Thanks to the efficient pre-rinse and rinse system, we have achieved a radical reduction in water consumption, up to using approximately one liter of water per basket only.

Pre-rinse saves water, rinse-aid and electricity because the water used for rinsing is collected and sent to the pre-rinse arms.. This result, besides respecting the environment, significantly saves chemicals and reduces the need for energy.



## CONTROL PANEL

The RK UP control panel with IPX5 membrane keyboard, allows both technicians and users to obtain comprehensive and detailed information on the machine operation. Its display with scrolling text provides data about the current status of the machine, such as boiler and tank temperatures, main alert codes and various programmable settings. The user-friendly control board, combined with the clear set of information provided to the user, make of Kromo display a reliable and effective control device for our machine.













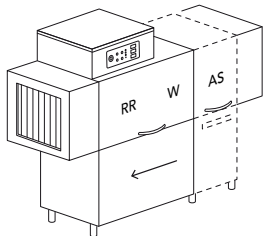



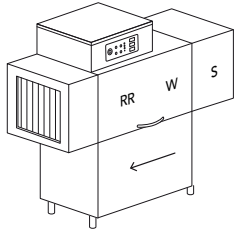



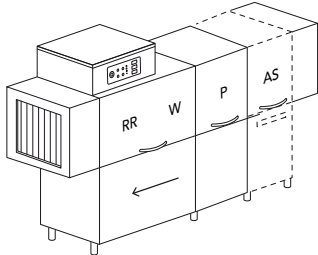

## FEATURES

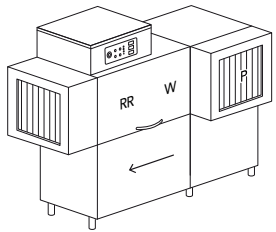
### STANDARD

- Electromechanical control panel
- Improved double rinse RR, more effective and with limited consumptions
- Double lateral drive system with incorporated clutch
- DRIVE speed variator with 3 speeds on the electromechanical versions and 5 speeds on the electronic versions
- AISI 316 stainless steel tanks and boilers

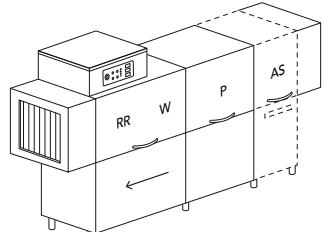









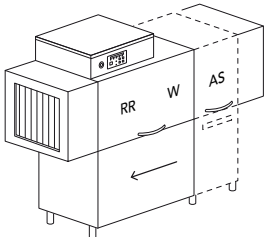



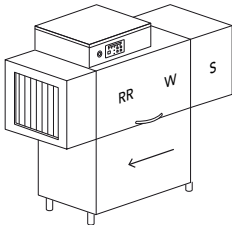



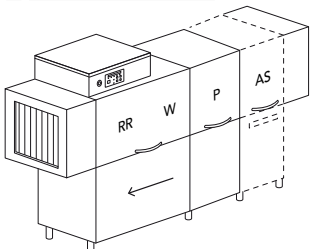

### OPTIONS

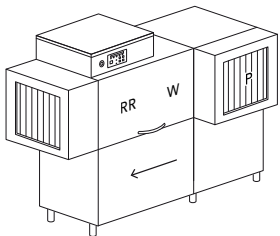
- Control panel with IPX5 membrane keyboard
- Linear and 90°/180° corner drying modules, power 4,5 kW or 9 kW (double skin dryer available for linear models only)
- Steam condenser (KSC10)
- Three models of heat recovery to be chosen according to the type of machine (compact, standard, or with built-in heat pump)
- Detergent dispenser with probe or dispensers kit
- Booster pump
- Water pressure security system Break Tank
- Extra power for the boiler
- Thermal and acoustic insulation
- Stainless steel pumps
- Centralized drain 1-DRAIN
- Variable speed inverter "drive" with 5 speeds (electronic version).
- Delivery in 2 or more parts to facilitate handling
- Machine sanitization (for electronic versions only) with dedicated booster pump

Model	Voltage	Capacity	Dimensions	Code
<b>RK 1040</b> 3 SPEEDS <b>IMPROVED</b> 	400 V 3N ~ 50 Hz 19,90 kW	 Ø 450  500x500 80* - 112 racks / h	1900x805 1830/2120 H 245 kg AS + 450 mm  530x325x25H	<b>RK 1040</b> <b>RK 1040 AS</b>
<b>RK 1440</b> 3 SPEEDS <b>IMPROVED</b> 	400 V 3N ~ 50 Hz 20,60 kW	 Ø 450  500x500 93* - 144 racks / h	2100x805 1830/2120 H 270 kg AS + 450 mm  530x325x25H	<b>RK 1440</b>
<b>RK 1840</b> 3 SPEEDS <b>IMPROVED</b> 	400 V 3N ~ 50 Hz 23,82 kW	 Ø 450  500x500 115* - 192 racks / h	2500x805 1830/2120 H 355 kg AS + 450 mm  530x325x25H	<b>RK 1840</b> <b>RK 1840 AS</b>
<b>RK 1840-K10</b> 3 SPEEDS - CORNER PREWASH <b>IMPROVED</b> 	400 V 3N ~ 50 Hz 23,82 kW	 Ø 450  500x500 115 - 192 racks / h	2225x985 1830/2120 H 355 kg AS + 450 mm  530x325x25H	<b>RK 1840-K10</b>
<b>RK 2440</b> 3 SPEEDS <b>IMPROVED</b> 	400 V 3N ~ 50 Hz 28,10 kW	 Ø 450  500x500 132* - 240 racks / h	2800x805 1830/2120 H 395 kg AS + 450 mm  530x325x25H	<b>RK 2440</b> <b>RK 2440 AS</b>

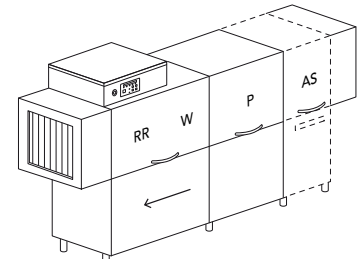
**P** Prewash  
**W** Wash  
**RR** Pre-rinse + rinse

**K10** Corner prewash  
**AS** Automatic shower with filter drawer +450 mm  
**S** Soaking

Model	Voltage	Capacity	Dimensions	Code	
<b>RK 1040 E 5 SPEEDS</b> <i>IMPROVED</i> 	RACK EQUIPMENT 1 X C40 1 X C43 1 X C44 1 X C47	400 V 3N ~ 50 Hz 19,90 kW	 Ø 450  500x500 80* - 112 racks / h	1900x805 1830/2120 H 245 kg AS + 450 mm  GN 1/1 530x325x25H	<b>RK 1040 E</b> <b>RK 1040 E AS</b>
<b>RK 1440 E 5 SPEEDS</b> <i>IMPROVED</i> 	RACK EQUIPMENT 1 X C40 1 X C43 1 X C44 1 X C47	400 V 3N ~ 50 Hz 20,60 kW	 Ø 450  500x500 93* - 144 racks / h	2100x805 1830/2120 H 270 kg  GN 1/1 530x325x25H	<b>RK 1440 E</b>
<b>RK 1840 E 5 SPEEDS</b> <i>IMPROVED</i> 	RACK EQUIPMENT 1 X C40 1 X C43 1 X C44 1 X C47	400 V 3N ~ 50 Hz 23,82 kW	 Ø 450  500x500 115* - 192 racks / h	2500x805 1830/2120 H 355 kg AS + 450 mm  GN 1/1 530x325x25H	<b>RK 1840 E</b> <b>RK 1840 E AS</b>
<b>RK 1840 E-K10 5 SPEEDS - CORNER PREWASH</b> <i>IMPROVED</i> 	RACK EQUIPMENT 1 X C40 1 X C43/B 1 X C44 1 X C47	400 V 3N ~ 50 Hz 23,82 kW	 Ø 450  500x500 115 - 192 racks / h	2225x985 1830/2120 H 355 kg  GN 1/1 530x325x25H	<b>RK 1840 E-K10</b>
<b>RK 2440 E 5 SPEEDS</b> <i>IMPROVED</i> 	RACK EQUIPMENT 1 X C40 1 X C43 1 X C44 1 X C47	400 V 3N ~ 50 Hz 28,10 kW	 Ø 450  500x500 132* - 240 racks / h	2800x805 1830/2120 H 395 kg AS + 450 mm  GN 1/1 530x325x25H	<b>RK 2440 E</b> <b>RK 2440 E AS</b>

\* Productivity according to DIN SPEC 10534 regulation ( contact time )

## OPTIONS

Model	220-240 V3 50 Hz		380-415 V 3N 50 Hz		60 Hz	Kromo disp. connections	Dispensers kit	Dispenser with probe	SAN Sanitization System	PAP-SAN Booster Pump Sanitiz.	KSC10 Steam cond.	KHR10 Heat recovery	KHR20 Heat recovery	KHRP40 Heat recovery
	€	●	+3%	●										
<b>RK 1040</b>	€	●	+3%	●		€	€	----	----	€	€	----	----	
<b>RK 1040 AS</b>	€	●	+3%	●		€	€	----	----	€	€	----	----	
<b>RK 1040 E*</b>	€	●	+3%	●		€	€	€	€	€	€	----	€	
<b>RK 1040 E AS</b>	€	●	+3%	●		€	€	€	€	€	€	----	€	
<b>RK 1440</b>	€	●	+3%	●		€	€	----	----	€	€	----	----	
<b>RK 1440 E</b>	€	●	+3%	●		€	€	€	€	€	€	----	€	
<b>RK 1840</b>	€	●	+3%	●		€	€	----	----	€	€	€	----	
<b>RK 1840 AS</b>	€	●	+3%	●		€	€	----	----	€	€	€	----	
<b>RK 1840 E</b>	€	●	+3%	●		€	€	€	€	€	€	€	€	
<b>RK 1840 E AS</b>	€	●	+3%	●		€	€	€	●	€	€	€	€	
<b>RK 1840-K10</b>	€	●	+3%	●		€	€	----	----	€	€	----	----	
<b>RK 1840 E-K10</b>	€	●	+3%	●		€	€	€	€	€	€	----	€	
<b>RK 2440</b>	€	●	+3%	●		€	€	----	----	€	€	€	----	
<b>RK 2440 AS</b>	€	●	+3%	●		€	€	----	----	€	€	€	----	
<b>RK 2440 E*</b>	€	●	+3%	●		€	€	€	€	€	€	€	€	
<b>RK 2440 E AS</b>	€	●	+3%	●		€	€	€	●	€	€	€	€	

● Standard

---- Not available

**E** Settable electronic panel

**KHRP40** Available with 400 V 3N 50 Hz frequency only

**KHR10 - KHR20 - KHRP40** In case of cold water supply for rinse (8-15 °C), we recommend to install the heat recovery system optional. Extra power included

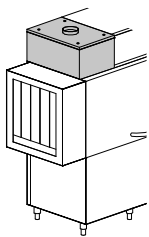

**KSC10**

Steam condenser

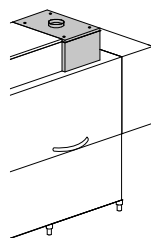

**KHR10**

Compact heat recovery

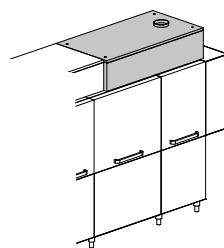

**KHR20**

heat recovery

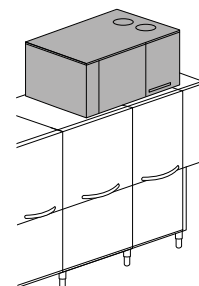

**KHRP40**

Heat recovery with heat pump



	DWI	PAP	DRIVE	AUTOTIMER	BT	DVGW	XP	DIV	PI	1-DRAIN
Model	Thermoacoustic insulation	Booster pump	Smart drive	Autotimer	Break tank	DVGW	Extra Power	Price for division	S/S pumps	Centralized Drain
<b>RK 1040</b>	€	€	●	----	----	----	€	€	€	€
<b>RK 1040 AS</b>	€	€	●	----	----	----	€	€	€	€
<b>RK 1040 E*</b>	€	€	●	●	€	€	€	€	€	€
<b>RK 1040 E AS</b>	€	€	●	●	€	€	€	€	€	€
<b>RK 1440</b>	€	€	●	----	----	----	€	€	€	€
<b>RK 1440 E</b>	€	€	●	●	€	€	€	€	€	€
<b>RK 1840</b>	€	€	●	----	----	----	€	€	€	€
<b>RK 1840 AS</b>	€	€	●	----	----	----	€	€	€	€
<b>RK 1840 E</b>	€	€	●	●	€	€	€	€	€	€
<b>RK 1840 E AS</b>	€	€	●	●	€	€	€	€	€	€
<b>RK 1840-K10</b>	€	€	●	----	----	----	€	€	€	€
<b>RK 1840 E-K10</b>	€	€	●	●	€	€	€	€	€	€
<b>RK 2440</b>	€	€	●	----	----	----	€	€	€	€
<b>RK 2440 AS</b>	€	€	●	----	----	----	€	€	€	€
<b>RK 2440 E*</b>	€	€	●	●	€	€	€	€	€	€
<b>RK 2440 E AS</b>	€	€	●	●	€	€	€	€	€	€

**+** Not available for K10 version if the machine is next to the wall

**\*** Construction according to UL-NSF standards upon request

**DDE-GROUP** Both detergent (with probe) and rinse-aid dispensers included

**DOS/S** For detergent dispenser only

**SAN** Including dosing system for sanitizing product

**DWI** Insulation option for the tunnel only, dryer excluded. Shelf dryer can be insulated upon request. Recommended with KHR10 – KHR20 – KHRP40

**DRIVE** Check voltage compatibility

**BT** Booster pump included

**DIV** For models RK 1040, RK 1040 E, RK 1440, RK 1440 E, Only splash guards removable

**PI** Available with 50 Hz frequency only. Not available for AS module

**DVGW** Not available with heat recovery and steam condenser  
Components prescribed by DVGW on request (check option compatibility with the manufacturer)

**XP** In case of cold water supply for rinse 8 °C 55 °C, and without any heat recovery, the extra power option is mandatory  
With osmotic water supply and electrical conductivity lower than 200 microsiemens, it is mandatory to install a stainless steel heat exchanger

We recommend to install the machine in a well ventilated room, with a properly sized steam exhausting system

Peak-cut connect upon request

Water supply 55 °C

Option compatibility to be confirmed by the manufacturer after verification

### OPTIONS

	KDR64	KDR69	KDR94	KDR99
Model	Dryer + 400 mm / 4,5 kW	Dryer + 400 mm / 9 kW	Dryer + 700 mm / 4,5 kW	Dryer + 700 mm / 9 kW
<b>RK 1040</b>	€	€	€	€
<b>RK 1040 AS</b>	€	€	€	€
<b>RK 1040 E *</b>	€	€	€	€
<b>RK 1040 E AS</b>	€	€	€	€
<b>RK 1440</b>	€	€	€	€
<b>RK 1440 E</b>	€	€	€	€
<b>RK 1840</b>	€	€	€	€
<b>RK 1840 AS</b>	€	€	€	€
<b>RK 1840 E</b>	€	€	€	€
<b>RK 1840 E AS</b>	€	€	€	€
<b>RK 1840-K10</b>	€	€	€	€
<b>RK 1840 E-K10</b>	€	€	€	€
<b>RK 2440</b>	€	€	€	€
<b>RK 2440 AS</b>	€	€	€	€
<b>RK 2440 E *</b>	€	€	€	€
<b>RK 2440 E AS</b>	€	€	€	€

**ID** Recommended for KDR69 - KDR99. Not available for corner dryers

**\*** Construction according to UL-NSF standards upon request

**KDR64 - KDR94 - KDRA94MC - KDRA184MC** With the models RK 1840 - RK 2440 verify feasibility with manufacturer

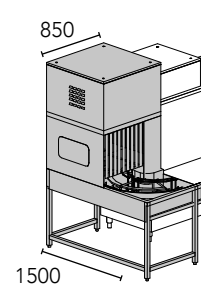
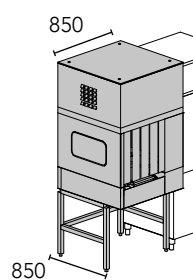
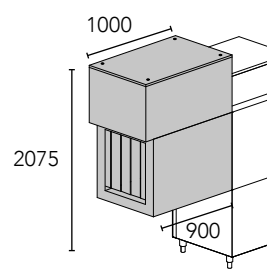
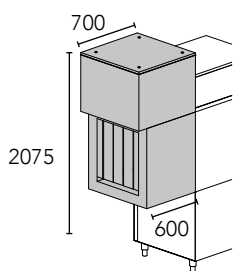

**KDR64** 4,5 kW Electric  
**KDR69** 9 kW Electric  
Dryer

**KDR94** 4,5 kW Electric  
**KDR99** 9 kW Electric  
Dryer

**KDRA94MC** 4,5 kW Electric  
**KDRA99MC** 9 kW Electric  
Dryer with mechanized arc 90°  
to be used with original Kromo  
racks only

**KDRA184MC** 4,5 kW Electric  
**KDRA189MC** 9 kW Electric  
Dryer with mechanized arc 180°  
to be used with original Kromo  
racks only

	KDRA94MC	KDRA99MC	KDRA184MC	KDRA189MC	ID
Model	Mechanized dryer 90° arc 4,5 kW	Mechanized dryer 90° arc 9 kW	Mechanized dryer 180° arc 4,5 kW	Mechanized dryer 180° arc 9 kW	Double skin for dryer
<b>RK 1040</b>	€	€	€	€	€
<b>RK 1040 AS</b>	€	€	€	€	€
<b>RK 1040 E *</b>	€	€	€	€	€
<b>RK 1040 E AS</b>	€	€	€	€	€
<b>RK 1440</b>	€	€	€	€	€
<b>RK 1440 E</b>	€	€	€	€	€
<b>RK 1840</b>	€	€	€	€	€
<b>RK 1840 AS</b>	€	€	€	€	€
<b>RK 1840 E</b>	€	€	€	€	€
<b>RK 1840 E AS</b>	€	€	€	€	€
<b>RK 1840-K10</b>	€	€	€	€	€
<b>RK 1840 E-K10</b>	€	€	€	€	€
<b>RK 2440</b>	€	€	€	€	€
<b>RK 2440 AS</b>	€	€	€	€	€
<b>RK 2440 E *</b>	€	€	€	€	€
<b>RK 2440 E AS</b>	€	€	€	€	€

**KM22 - KM23** Available on entry or exit connections, one per layout

**KDRA184MC - KDRA189MC** Mandatory division

**KDRA94MC - KDRA99MC - KDRA184MC - KDRA189MC** Available only without KM22 - KM23 on entry

## AVAILABLE ARCS:

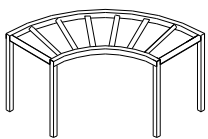

**K21**  
1300x1300x860 H  
90° roller arc with tank

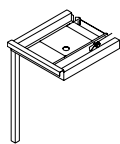



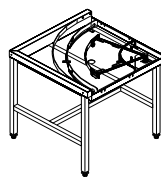

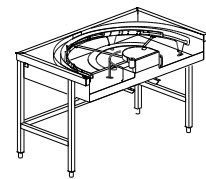

**K25**  
700x610x820 H  
Angle loading table complete  
with basket  
pull-through system

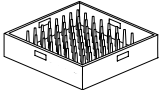
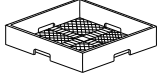
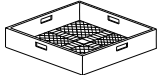
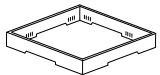

**KM22**  
850x850x885 H  
90° mechanized arc  
( clockwise/counter-clockwise )  
to be used with original Kromo  
racks only

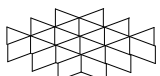

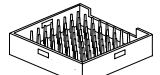
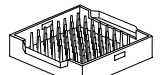
**KM23**  
850x1500x885 H  
180° mechanized arc  
( clockwise/counter-clockwise )  
to be used with original Kromo  
racks only

	Description	Capacity	Dimensions	Code	
	PLATE BASKET	18 plates	500x500x105 H	<b>C 40</b>	
	NARROW MESH CUTLERY BASKET		500x500x106 H	<b>C 41</b>	
	LARGE MESH BASKET	For glasses	500x500x105 H	<b>C 44</b>	
	HOLDER FOR GLASS SUPPORT	For glass support (C112-C113-C114)	500x500x50 H	<b>C 111</b>	
	GLASS SUPPORT	5x5 Glass Ø 87 mm (C111)	500x500x50 H	<b>C 112</b>	
	GLASS SUPPORT	4x4 Glass Ø 110 mm (C111)	500x500x50 H	<b>C 113</b>	
	GLASS SUPPORT	6x6 Glass Ø 72 mm (C111)	500x500x50 H	<b>C 114</b>	
	TRAYS BASKET	8 pcs, max. depth 25 mm	500x500x105 H	<b>C 43</b>	
	GASTRONORM TRAYS BASKET GN 1/1	6 pcs, max. depth 25 mm	500x500x105 H	<b>C 43/B</b>	
	CUTLERY BASKET		490x180x140 H	<b>C 47</b>	
	FLEXIBLE SHOWER complete with mixing group and lever tap, to be fixed to the wall		1000 H	<b>K 1</b>	
	FLEXIBLE SHOWER complete with mixing group and lever tap, to be fixed to the wall and intermediate tap		1000 H	<b>K 1HR</b>	

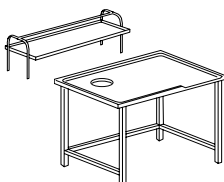
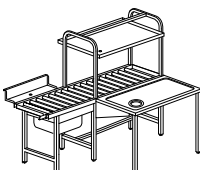
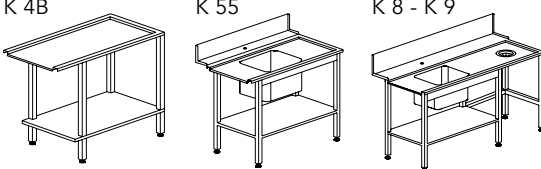
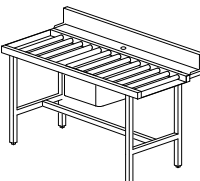
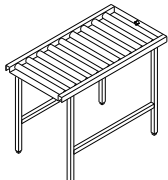
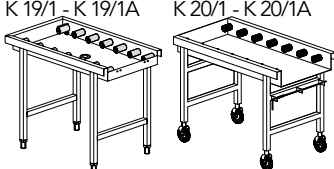
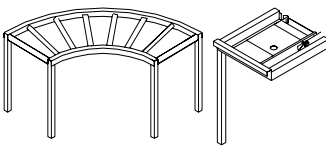
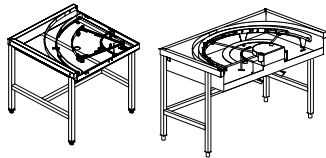
	Description	Capacity	Dimensions	Code
	SHELF		1515x620x660 H	<b>K 7M16*</b>
			2315x620x660 H	<b>K 7M24*</b>
	GRADING TABLE WITH RUBBER RING	Waste hole and special dimensions upon request	1600x1000x850 H	<b>K 7A/1600*</b>
			2400x1000x850 H	<b>K 7A/2400*</b>
	MECHANIZED GRADING TABLE With mechanized basket advancement system	1 waste hole	1800x1240 1525 H	<b>K M7/1800*</b>
		2 waste holes	2400x1240 1525 H	<b>K M7/2400*</b>
			1200x590x860 H	<b>K 4B</b>
			1200x730x860 H	<b>K 55</b>
		Standard rubber ring	1500x730x860 H	<b>K 8</b>
		Standard rubber ring	1800x730x860 H	<b>K 9</b>
	Sink 500x400x270 H	Sink 500x400x270 H		
	ROLLER TABLE + sink, right or left version		1600x730x860 H	<b>K 195</b>
	Sink 500x400x270 H			
	LINEAR ROLLER TABLE WITH TANK		1100x650x860 H	<b>K 19*</b>
			1600x650x860 H	<b>K 19/B*</b>
			2100x650x860 H	<b>K 19/C*</b>
		Option end microswitch		<b>K 18</b>
	LINEAR ROLLER TABLE WITH TANK complete with end microswitch	Not compatible with same references Not on 180° arcs	1100x650x860 H	<b>K 19/1</b>
			1600x650x860 H	<b>K 19/1A</b>
		To be connected to KM23 only and to dryer on 180°	1150x650x860 H	<b>K 20/1</b>
			1650x650x860 H	<b>K 20/1A</b>
	90°roller arc with tank (exit only with roller table)		1300x1300x860 H	<b>K 21*</b>
	ANGLE LOADING TABLE complete with basket pull-through system	Optional connection to prewash tables	700x610x820 H	<b>K 25</b>
	90° MECHANIZED ARC ( clockwise/counter-clockwise ) not available at the entry on K10 version	Available on entry or exit connections, one per layout.	850x850x885 H	<b>KM 22 *</b>
	180° MECHANIZED ARC ( clockwise/counter-clockwise )	To be used with original KROMO racks only	850x1500x885 H	<b>KM 23 *</b>

\* Wooden cage +2% minimum + € / Special dimensions for tables upon request / Tables shown in right-to-left version

We strongly recommend the presence of a roller table with end microswitch at the exit of our rack type machines for a correct operation



The KROMO rack-type dishwashers are the ideal answer for demanding customers such as restaurants, canteens, schools, hospitals, hotel of any size, cruise-liners, caterers and airports. Models equipped with reinforced double rinse on an independent module. Wash and rinse areas are completely separated, this avoids any interference between detergent and rinse aid, increasing its effectiveness and achieving a consequent reduction in consumption.

The wider distance between the pre-rinse arms also avoids the contamination in the rinse zone. Thanks to the renewed double rinsing system, we achieved a radical reduction of water consumption down to less than one liter per basket: far below the best market standards. This result, showing the green heart of the RK LUX line, allows significant savings on chemicals and electricity bills.



## FEATURES

### STANDARD

- SMART DRIVE advancement system with 5 speeds
- IPX5 electronic board
- TFT 5.7" display and soft touch keyboard
- Frequently used keys shortcut and menu language setting
- Constant monitoring of key operating parameters with integrated HACCP interface
- Alarms and events report
- ECO-DET Detergent economizer
- Reinforced double rinse 2R+, more effective and with limited consumptions
- 1-DRAIN Centralized drain
- Preset configuration to install our KROMO dispensers
- Water, energy consumptions and working time readout
- Preset maintenance reminder
- Possible working modes for dryer unit: all off, only fan or total power + fan (4,5 kW or 9 kW, maximum power according to the model)
- AISI 316 stainless steel tanks and boilers

### OPTIONS

- Linear and 90°/180° corner drying modules, power 4,5 kW or 9 kW (double skin door available only for linear models) and steam dryer available
- Steam condenser (KSC10) or 3 heat recovery systems, to be chosen according to the type of machine (XP included)
- Detergent dispenser with probe or dispensers kit
- Booster pump
- Hydraulic security system Break Tank
- Extra power for boiler
- Thermal and acoustic insulation
- Insulated tanks
- Stainless steel pumps
- Machine sanitization (with dedicated booster pump upon request)
- Delivery in 2 or more parts for easy handling
- CONNECTIVITY remote control compliant with the HACCP norms

## CONNECTIVITY 4.0 & APP

WHEREVER YOU ARE...  
YOUR DISHWASHER, JUST A CLICK AWAY

You will be constantly connected to the machine to monitor the work phases, review any eventual alarm and configure remotely the operating parameters according to your needs. Compliant with HACCP norms. Thanks to our brand new App, you will have access to connected machines and all commercial and technical documentation.

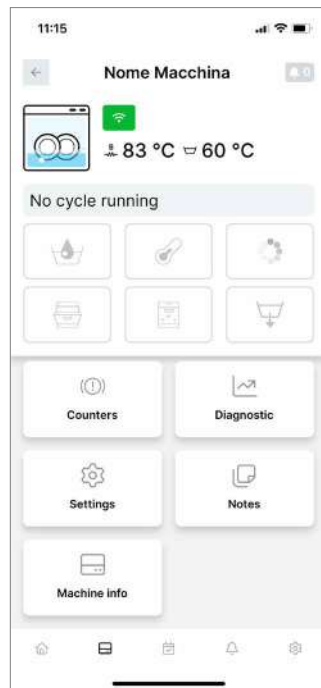

View all the working parameters and event records, working hours and any problem at any time.



In case of problem, the machine promptly alerts you. The technician can intervene remotely to solve the problem or anticipate the needed parts for an on-site intervention.



A daily activity report is available with all the events related to the dishwasher in a detailed spreadsheet with HACCP data.



Our Connectivity system is a revolutionary device limiting and facilitating the eventual intervention of a technician who can anticipate the necessary parts to be replaced, saving time and money.



## AS OPTION

### AUTOMATIC SHOWER WITH FILTER DRAWER EASY+

Time and energy savings are increased thanks to AS and EASY+, a combined and specific filtering device. Dishes will only need a superficial manual clearing and the automatic shower of the AS module will do a pre-treatment action. (Not available with an installed K10 option).

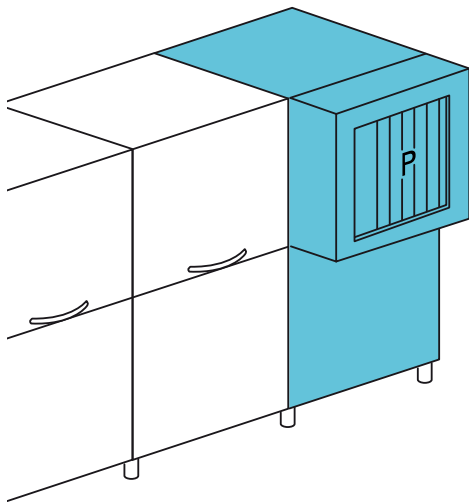
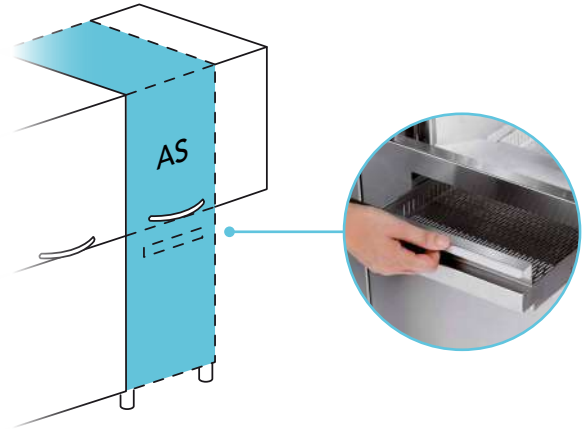

## K10 OPTION

### 90° CORNER PRE-WASH









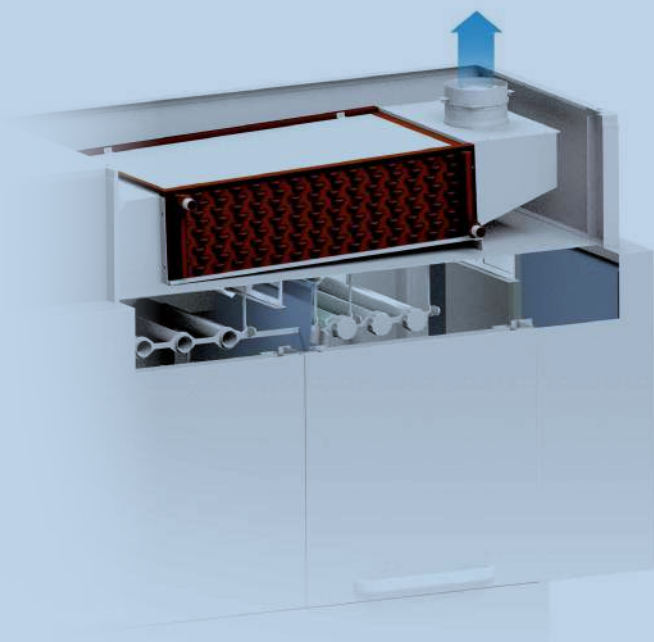

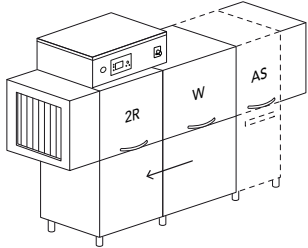



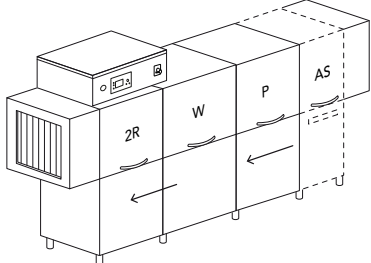

The design of our 90° corner pre-wash ensures the best solution taking up the minimal amount of space. Smaller dimensions, same productivity (Available on selected models and without AS option).

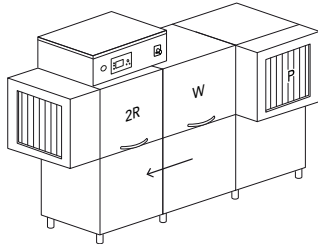



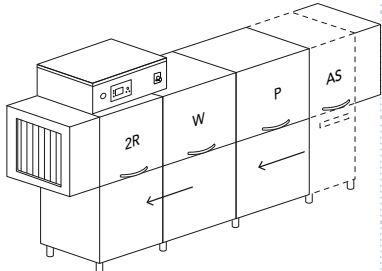





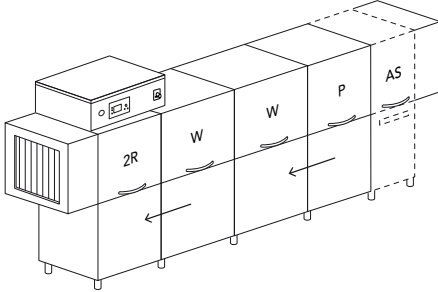

## HEAT RECOVERY

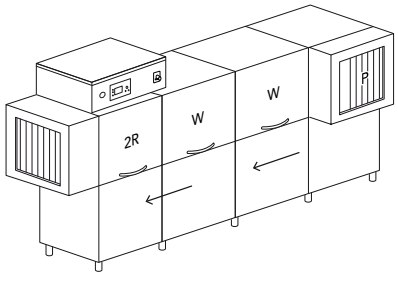
The heat recovery system allows to supply the machine with cold water\*, ensuring at the same time significant savings in terms of energy consumptions. The steam produced by the machine in operation (otherwise dispersed in the working environment) is aspirated and condensed in the heat exchanger (air-water). The heat produced through this process is transferred to the inlet water, bringing it to a temperature of approximately 45 °C and reducing energy consumptions.

\*inlet water temperature between 8 °C and 15 °C

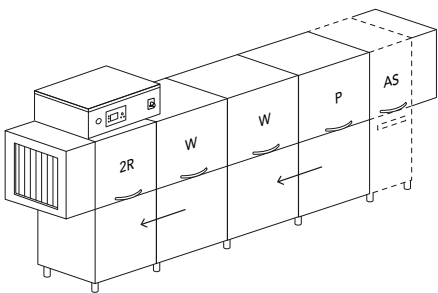

Model	Voltage	Capacity	Dimensions	Code	
<b>RK 2460 5 SPEEDS</b>					
	<b>RACK EQUIPMENT</b> 1 X C40 1 X C43 1 X C44 1 X C47	400 V 3N ~ 50 Hz 20,68 kW	 Ø 450   500x500	2100x805 1830/2120 H 305 kg  AS + 450 mm   530x325x25H	<b>RK 2460</b>  <b>RK 2460 AS</b>  <b>RK 2460 V</b>
	400 V 3N ~ 50 Hz 2,68 kW 30 kg/h	100* - 250 racks / h	<b>RK 2460 AS V</b>		
<b>RK 2960 5 SPEEDS</b>					
	<b>RACK EQUIPMENT</b> 1 X C40 1 X C43 1 X C44 1 X C47	400 V 3N ~ 50 Hz 21,58 kW	 Ø 450   500x500	2700x805 1830/2120 H 400 kg  AS + 450 mm   530x325x25H	<b>RK 2960</b>  <b>RK 2960 AS</b>  <b>RK 2960 V</b>
	400 V 3N ~ 50 Hz 3,58 kW 30 kg/h	135* - 300 racks / h	<b>RK 2960 AS V</b>		
<b>RK 2960-K10 5 SPEEDS - CORNER PREWASH</b>					
	<b>RACK EQUIPMENT</b> 1 X C40 1 X C43/B 1 X C44 1 X C47	400 V 3N ~ 50 Hz 21,58 kW	 Ø 450   500x500	2425x985 1830/2120 H 400 kg  AS + 450 mm   530x325x25H	<b>RK 2960-K10</b>  <b>RK 2960-K10 V</b>
	400 V 3N ~ 50 Hz 3,58 kW 30 kg/h	135 - 300 racks / h			
<b>RK 3260 5 SPEEDS</b>					
	<b>RACK EQUIPMENT</b> 1 X C40 1 X C43 1 X C44 1 X C47	400 V 3N ~ 50 Hz 25,86 kW	 Ø 450   500x500	3000x805 1830/2120 H 435 kg  AS + 450 mm   530x325x25H	<b>RK 3260</b>  <b>RK 3260 AS</b>  <b>RK 3260 V</b>
	400 V 3N ~ 50 Hz 4,86 kW 30 kg/h	150* - 330 racks / h	<b>RK 3260 AS V</b>		

Model	Voltage	Capacity	Dimensions	Code
<b>RK 3560 5 SPEEDS</b>				
	<b>RACK EQUIPMENT</b> 1 X C40 1 X C43 1 X C44 1 X C47	400 V 3N ~ 50 Hz 37,26 kW	 Ø 450	<b>RK 3560</b>  <b>RK 3560 AS</b>  <b>RK 3560 V</b>
		400 V 3N ~ 50 Hz 5,76 kW 52 kg/h	 500x500  190* - 360 racks / h	3600x805 1830/2120 H 520 kg  AS + 450 mm   <b>RK 3560 V</b>  <b>RK 3560 AS V</b>
<b>RK 3560-K10 5 SPEEDS - CORNER PREWASH</b>				
	<b>RACK EQUIPMENT</b> 1 X C40 1 X C43/B 1 X C44 1 X C47	400 V 3N ~ 50 Hz 37,26 kW	 Ø 450	<b>RK 3560-K10</b>  <b>RK 3560-K10 V</b>
		400 V 3N ~ 50 Hz 5,76 kW 52 kg/h	 500x500  190* - 360 racks / h	3325x985 1830/2120 H 520 kg   <b>RK 3560-K10 V</b>
<b>RK 3960 5 SPEEDS</b>				
	<b>RACK EQUIPMENT</b> 1 X C40 1 X C43 1 X C44 1 X C47	400 V 3N ~ 50 Hz 40,04 kW	 Ø 450	<b>RK 3960</b>  <b>RK 3960 AS</b>  <b>RK 3960 V</b>
		400 V 3N ~ 50 Hz 7,04 kW 55 kg/h	 500x500  210* - 400 racks / h	3900x805 1830/2120 H 560 kg  AS + 450 mm   <b>RK 3960 V</b>  <b>RK 3960 AS V</b>

- V** Steam supply
- P** Prewash
- W** Wash
- 2R** Double reinforced rinse (pre-rinse + rinse on module)
- K10** Corner prewash
- AS** Automatic shower with filter drawer +450 mm
- \*** Productivity according to DIN SPEC 10534 regulation ( contact time )

EAC label upon request

Option compatibility to be confirmed by the manufacturer after verification

## OPTIONS

Model				PRE DOS	DDE-GROUP	DOS/S	SAN	PAP-SAN	DWI / T	DWI
	220-240 V 3 50 Hz	380-415 V 3N 50 Hz	60 Hz	Kromo disp. connections	Dispensers kit	Dispenser with probe	Sanitization System	Booster Pump Sanitiz.	Tank insulation	Thermoacou- stic insulation
<b>RK 2460</b>	€	●	+ 3%	●	€	€	€	€	€	€
<b>RK 2460 V</b>	€	●	+ 3%	●	€	€	€	€	€	€
<b>RK 2460 AS</b>	€	●	+ 3%	●	€	€	€	€	€	€
<b>RK 2460 AS V</b>	€	●	+ 3%	●	€	€	€	€	€	€
<b>RK 2960</b>	€	●	+ 3%	●	€	€	€	€	€	€
<b>RK 2960 V</b>	€	●	+ 3%	●	€	€	€	€	€	€
<b>RK 2960 AS</b>	€	●	+ 3%	●	€	€	€	●	€	€
<b>RK 2960 AS V</b>	€	●	+ 3%	●	€	€	€	●	€	€
<b>RK 2960-K10</b>	€	●	+ 3%	●	€	€	€	€	€	€
<b>RK 2960-K10 V</b>	€	●	+ 3%	●	€	€	€	€	€	€
<b>RK 3260</b>	€	●	+ 3%	●	€	€	€	€	€	€
<b>RK 3260 V</b>	€	●	+ 3%	●	€	€	€	€	€	€
<b>RK 3260 AS</b>	€	●	+ 3%	●	€	€	€	●	€	€
<b>RK 3260 AS V</b>	€	●	+ 3%	●	€	€	€	●	€	€
<b>RK 3560</b>	€	●	+ 3%	●	€	€	€	●	€	€
<b>RK 3560 V</b>	€	●	+ 3%	●	€	€	€	●	€	€
<b>RK 3560 AS</b>	€	●	+ 3%	●	€	€	€	●	€	€
<b>RK 3560 AS V</b>	€	●	+ 3%	●	€	€	€	●	€	€
<b>RK 3560-K10</b>	€	●	+ 3%	●	€	€	€	●	€	€
<b>RK 3560-K10 V</b>	€	●	+ 3%	●	€	€	€	●	€	€
<b>RK 3960</b>	€	●	+ 3%	●	€	€	€	●	€	€
<b>RK 3960 V</b>	€	●	+ 3%	●	€	€	€	●	€	€
<b>RK 3960 AS</b>	€	●	+ 3%	●	€	€	€	●	€	€
<b>RK 3960 AS V</b>	€	●	+ 3%	●	€	€	€	●	€	€

● Standard

---- Not available

**DDE-GROUP** Both detergent (with probe) and rinse-aid dispensers included

**DOS/S** For detergent dispenser only

**SAN** Including dosing system for sanitizing product

**DWI** Insulation option for the tunnel only, dryer excluded. Shelf dryer can be insulated upon request. Recommended with KHR10 – KHR20 – KHRP40

**DWI - DWI/T** Recommended with KHR10 – KHR20 – KHRP40

**DIV** Compulsory for machines > 4,5 m

**XP** In case of cold water supply for rinse 8 °C 55 °C, and without any heat recovery, the extra power option is mandatory

	PAP	BT	DVGW	XP	DIV	CONN.	PI	SA	1-DRAIN	AUTOTIMER	ECO-DET	DRIVE
Model	Booster pump	Break tank	DVGW	Extra Power	Price for division	Connectivity (HACCP)	S/S pumps	Automatized Drain	Centralized Drain	Autotimer	Detergent economizer	Smart drive 5 speeds
<b>RK 2460</b>	€	€	€	€	€	€	€	€	●	●	●	●
<b>RK 2460 V</b>	€	€	€	€	€	€	€	----	●	●	●	●
<b>RK 2460 AS</b>	€	€	€	€	€	€	€	€	●	●	●	●
<b>RK 2460 AS V</b>	€	€	€	€	€	€	€	----	●	●	●	●
<b>RK 2960</b>	€	€	€	€	€	€	€	€	●	●	●	●
<b>RK 2960 V</b>	€	€	€	€	€	€	€	----	●	●	●	●
<b>RK 2960 AS</b>	€	€	€	€	€	€	€	€	●	●	●	●
<b>RK 2960 AS V</b>	€	€	€	€	€	€	€	----	●	●	●	●
<b>RK 2960-K10</b>	€	€	€	€	€	€	€	€	●	●	●	●
<b>RK 2960-K10 V</b>	€	€	€	€	€	€	€	----	●	●	●	●
<b>RK 3260</b>	€	€	€	€	€	€	€	€	●	●	●	●
<b>RK 3260 V</b>	€	€	€	€	€	€	€	----	●	●	●	●
<b>RK 3260 AS</b>	€	€	€	€	€	€	€	€	●	●	●	●
<b>RK 3260 AS V</b>	€	€	€	€	€	€	€	----	●	●	●	●
<b>RK 3560</b>	€	€	€	----	€	€	€	€	●	●	●	●
<b>RK 3560 V</b>	€	€	€	----	€	€	€	----	●	●	●	●
<b>RK 3560 AS</b>	€	€	€	----	€	€	€	€	●	●	●	●
<b>RK 3560 AS V</b>	€	€	€	----	€	€	€	----	●	●	●	●
<b>RK 3560-K10</b>	€	€	€	----	€	€	€	€	●	●	●	●
<b>RK 3560-K10 V</b>	€	€	€	----	€	€	€	----	●	●	●	●
<b>RK 3960</b>	€	€	€	----	€	€	€	€	●	●	●	●
<b>RK 3960 V</b>	€	€	€	----	€	€	€	----	●	●	●	●
<b>RK 3960 AS</b>	€	€	€	----	€	€	€	€	●	●	●	●
<b>RK 3960 AS V</b>	€	€	€	----	€	€	€	----	●	●	●	●

**CONNECTIVITY** Includes HACCP option. 10 year plan

**PI** Available with 50 Hz frequency only. Not available for AS module

**DVGW** Not available with heat recovery and steam condenser  
Components prescribed by DVGW on request (check option compatibility with the manufacturer)

**BT** Booster pump included

With osmotic water supply and electrical conductivity lower than 200 microsiemens, it is mandatory to install a stainless steel heat exchanger

Water supply 55 °C

We recommend to install the machine in a well ventilated room, with a properly sized steam exhausting system

Standard hints for scheduled maintenance and counters (working hours - water - energy)

Peak-cut connect upon request

### OPTIONS

Model	KSC10	KHR10	KHR20	KHRP40	KDR64	KDR69	KDR6V	KDR94	KDR99	KDR9V
	Steam con- denser	heat recovery	heat recovery	heat recovery	Dryer + 400 mm / 4,5 kW	Dryer + 400 mm / 9 kW	Steam dryer + 400 mm	Dryer + 700 mm / 4,5 kW	Dryer + 700 mm / 9 kW	Steam dryer + 700 mm
<b>RK 2460 - RK 2460 AS</b>	€	€	----	€	€	€	----	€	€	----
<b>RK 2460 V - RK 2460 AS V</b>	€	€	----	€	----	----	€	----	----	€
<b>RK 2960 - RK 2960 AS</b>	€	€	€	€	€	€	----	€	€	----
<b>RK 2960 V - RK 2960 AS V</b>	€	€	€	€	----	----	€	----	----	€
<b>RK 2960-K10</b>	€	€	€	€	€	€	----	€	€	----
<b>RK 2960-K10 V</b>	€	€	€	€	----	----	€	----	----	€
<b>RK 3260 - RK 3260 AS</b>	€	€	€	€	€	€	----	€	€	----
<b>RK 3260 V - RK 3260 AS V</b>	€	€	€	€	----	----	€	----	----	€
<b>RK 3560 - RK 3560 AS</b>	€	€	€	€	€	€	----	€	€	----
<b>RK 3560 V - RK 3560 AS V</b>	€	€	€	€	----	----	€	----	----	€
<b>RK 3560-K10</b>	€	€	€	€	€	€	----	€	€	----
<b>RK 3560-K10 V</b>	€	€	€	€	----	----	€	----	----	€
<b>RK 3960 - RK 3960 AS</b>	€	€	€	€	€	€	----	€	€	----
<b>RK 3960 V - RK 3960 AS V</b>	€	€	€	€	----	----	€	----	----	€

**+** Not available for K10 version if the machine is next to the wall

**ID** Recommended for KDR69 - KDR6V - KDR99 - KDR9V. Not available for corner dryers

**KHRP40** Available with 400 V 3N 50 Hz frequency only

**KHR20** As an alternative KHR10 or KHRP40

For the model RK 2960-K10 +50 mm length with installed KHR20 and dryer

**KDRA184MT - KDRA189MT** Mandatory division

**KHR10-KHR20-KHRP40** In case of cold water supply for rinse (8-15 °C), we recommend to install the heat recovery system optional.

**KDR64 - KDR94 - KDRA94MT - KDRA184MT** Not recommended for models RK 2960, RK 3260, RK 3560, RK 3960. Verify with manufacturer

Option compatibility to be confirmed by the manufacturer after verification

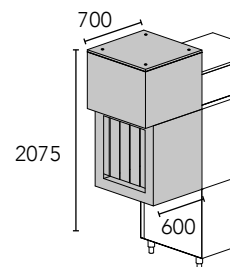
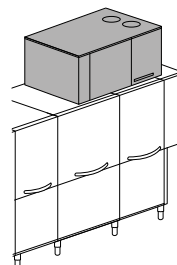
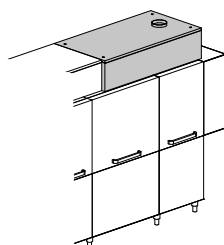
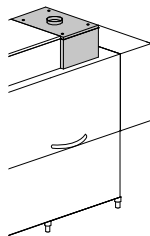
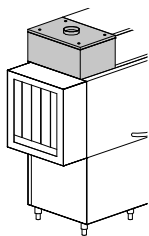

**KSC10**

Steam condenser

**KHR10**

Compact heat recovery

**KHR20**

Heat recovery

**KHRP40**

Heat recovery with heat pump

**KDR64**

4,5 kW Electric

**KDR69**

9 kW Electric

Dryer

**KDR6V**

Steam dryer

	KDRA94MT	KDRA99MT	KDRA9VMT	KDRA184MT	KDRA189MT	KDRA18VMT	ID
Model	Motorized dryer 90° arc 4,5 kW	Motorized dryer 90° arc 9 kW	Motorized steam dryer 90° arc	Motorized dryer 180° arc 4,5 kW	Motorized dryer 180° arc 9 kW	Motorized steam dryer 180° arc	Double skin for dryer
<b>RK 2460 - RK 2460 AS</b>	€	€	----	€	€	----	€
<b>RK 2460 V - RK 2460 AS V</b>	----	----	€	----	----	€	€
<b>RK 2960 - RK 2960 AS</b>	€	€	----	€	€	----	€
<b>RK 2960 V - RK 2960 AS V</b>	----	----	€	----	----	€	€
<b>RK 2960-K10</b>	€	€	----	€	€	----	€
<b>RK 2960-K10 V</b>	----	----	€	----	----	€	€
<b>RK 3260 - RK 3260 AS</b>	€	€	----	€	€	----	€
<b>RK 3260 V - RK 3260 AS V</b>	----	----	€	----	----	€	€
<b>RK 3560 - RK 3560 AS</b>	€	€	----	€	€	----	€
<b>RK 3560 V - RK 3560 AS V</b>	----	----	€	----	----	€	€
<b>RK 3560-K10</b>	€	€	----	€	€	----	€
<b>RK 3560-K10 V</b>	----	----	€	----	----	€	€
<b>RK 3960 - RK 3960 AS</b>	€	€	----	€	€	----	€
<b>RK 3960 V - RK 3960 AS V</b>	----	----	€	----	----	€	€

**AVAILABLE ARCS:**

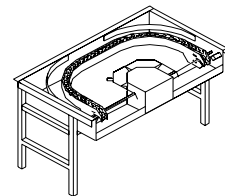
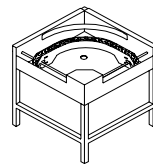
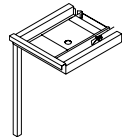
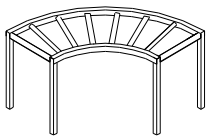

**K 21** 1300x1300x860 H  
90° roller arc with tank

**K 25** 700x610x820 H  
Angle loading table complete with  
basket pull-through system

**K 22** 850x850x885 H  
90° motorized arc ( clockwise/  
counter-clockwise )

**K 23** 850x1500x885 H  
180° motorized arc ( clockwise/  
counter-clockwise )

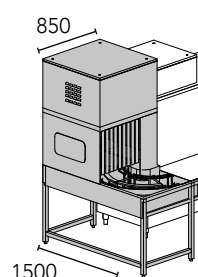
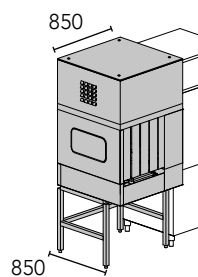
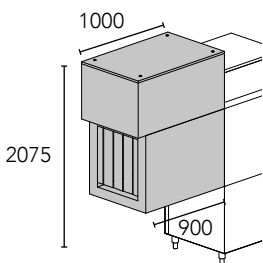

**KDR94** 4,5 kW Electric  
**KDR99** 9 kW Electric  
Dryer



**KDRA94MT** 4,5 kW Electric  
**KDRA99MT** 9 kW Electric  
Dryer with mechanized arc 90°

**KDRA184MT** 4,5 kW Electric  
**KDRA189MT** 9 kW Electric  
Dryer with mechanized arc 180°

**KDR9V**  
Steam dryer

**KDRA9VMT**  
Steam dryer with motorized arc 90°

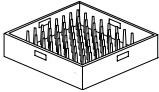
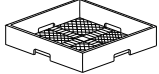
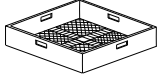
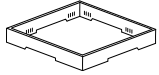
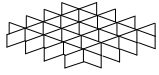
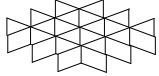
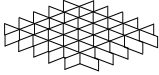
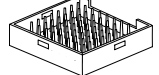
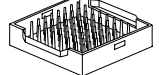
**KDRA18VMT**  
Steam dryer with motorized arc 180°

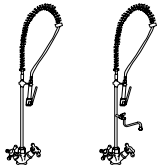
	Description	Capacity	Dimensions	Code	
	PLATE BASKET	18 plates	500x500x105 H	<b>C 40</b>	
	NARROW MESH CUTLERY BASKET		500x500x106 H	<b>C 41</b>	
	LARGE MESH BASKET	For glasses	500x500x105 H	<b>C 44</b>	
	HOLDER FOR GLASS SUPPORT	For glass support (C112-C113-C114)	500x500x50 H	<b>C 111</b>	
	GLASS SUPPORT	5x5 Glass Ø 87 mm (C111)	500x500x50 H	<b>C 112</b>	
	GLASS SUPPORT	4x4 Glass Ø 110 mm (C111)	500x500x50 H	<b>C 113</b>	
	GLASS SUPPORT	6x6 Glass Ø 72 mm (C111)	500x500x50 H	<b>C 114</b>	
	TRAYS BASKET	8 pcs, max. depth 25 mm	500x500x105 H	<b>C 43</b>	
	GASTRONORM TRAYS BASKET GN 1/1	6 pcs, max. depth 25 mm	500x500x105 H	<b>C 43/B</b>	
	CUTLERY BASKET		490x180x140 H	<b>C 47</b>	
	FLEXIBLE SHOWER complete with mixing group and lever tap, to be fixed to the wall		1000 H	<b>K 1</b>	
	FLEXIBLE SHOWER complete with mixing group and lever tap, to be fixed to the wall and intermediate tap		1000 H	<b>K 1HR</b>	

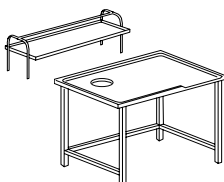
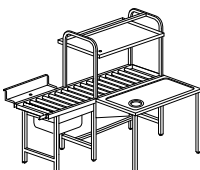
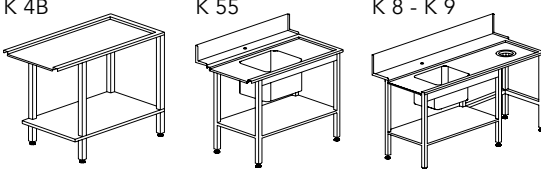
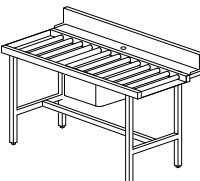
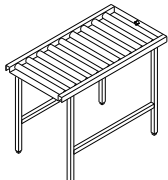
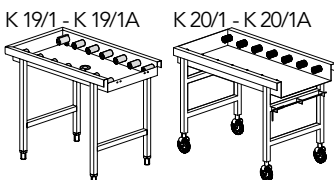
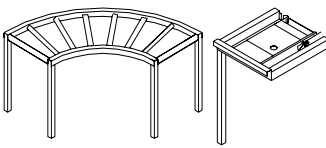
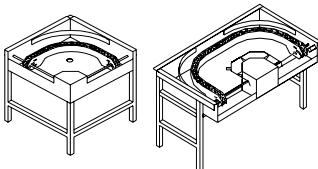

	Description	Capacity	Dimensions	Code
	SHELF		1515x620x660 H	<b>K 7M16*</b>
			2315x620x660 H	<b>K 7M24*</b>
	GRADING TABLE WITH RUBBER RING	Waste hole and special dimensions upon request	1600x1000x850 H	<b>K 7A/1600*</b>
			2400x1000x850 H	<b>K 7A/2400*</b>
	MECHANIZED GRADING TABLE With mechanized basket advancement system	1 waste hole	1800x1240 1525 H	<b>K M7/1800*</b>
		2 waste holes	2400x1240 1525 H	<b>K M7/2400*</b>
			1200x590x860 H	<b>K 4B</b>
			1200x730x860 H	<b>K 55</b>
		Standard rubber ring	1500x730x860 H	<b>K 8</b>
		Standard rubber ring	1800x730x860 H	<b>K 9</b>
	ROLLER TABLE + sink, right or left version			
	Sink 500x400x270 H		1600x730x860 H	<b>K 195</b>
	LINEAR ROLLER TABLE WITH TANK		1100x650x860 H	<b>K 19*</b>
			1600x650x860 H	<b>K 19/B*</b>
			2100x650x860 H	<b>K 19/C*</b>
		Option end microswitch		<b>K 18</b>
	LINEAR ROLLER TABLE WITH TANK complete with end microswitch	Not compatible with same references Not on 180° arcs	1100x650x860 H	<b>K 19/1</b>
			1600x650x860 H	<b>K 19/1A</b>
		To be connected to KM23 only and to dryer on 180°	1150x650x860 H	<b>K 20/1</b>
			1650x650x860 H	<b>K 20/1A</b>
	90°roller arc with tank (exit only with roller table)		1300x1300x860 H	<b>K 21*</b>
	ANGLE LOADING TABLE complete with basket pull-through system	Optional connection to prewash tables	700x610x820 H	<b>K 25</b>
	90° MOTORIZED ARC ( clockwise/counter-clockwise )		850x850x885 H	<b>K 22*</b>
	180° MOTORIZED ARC ( clockwise/counter-clockwise )		850x1500x885 H	<b>K 23*</b>

\* Wooden cage +2% minimum + € / Special dimensions for tables upon request / Tables shown in right-to-left version

We strongly recommend the presence of a roller table with end microswitch at the exit of our rack type machines for a correct operation



Thanks to the rack conveyor dishwashers of RK PREMIUM series, new efficiency goals are met. The 3R + three-step rinse system ensures considerable savings in terms of water consumption and unmatched quality results. The reduction of heat losses granted by walls thermal insulation, the heat recovered from the steam produced inside the machine (with optional HDR), are just some points of strength of this product range, whose main innovation is an important reduction of waste.

Their user-friendly design characterizes both the washing process and the daily cleaning and maintenance operations. The wide TFT screen makes the access to operating functions easy and comfortable. The IPX5 control panel, the rack-washing arms, the machine sanitization and the automatic drain options, make all the end of the day operations much more comfortable.



## FEATURES

### STANDARD

- TFT 5.7" display and soft touch keyboard
- IPX5 electronic board
- Easy-access frontal panel
- Constant monitoring of key operating parameters with integrated HACCP interface
- Detailed information and history of alarms in 6 languages
- Chemicals level management and related alerts/information
- SMART DRIVE+ advancement system with 10 speeds
- ECO-DET Detergent economizer
- Triple reinforced rinse 3R+ with adjustable water flow
- 1-DRAIN centralized drain
- Break Tank with integrated booster pump
- Thermal and acoustic insulation, insulated tanks
- Battery auto-cleaning for heat recovery system (if HDR option present)
- Control function for water, energy consumptions and working time
- Possible working modes for dryer unit: all off, only fan or total power + fan (4,5 kW or 9 kW, maximum power according to the model)
- Preset maintenance reminder
- AISI 316 stainless steel tanks and boilers

### OPTIONS

- Automated tanks and boiler fill/drain through SA servovalves
- Detergent dispenser with probe or dispensers kit
- Extra power for boiler
- KHDR200: insulated dryer + heat recovery system
- KHDRA209M and KHDRA218M, insulated, on 90°/180° motorized chain conveyor
- Machine sanitization with dedicated booster pump
- Stainless steel pumps
- CONNECTIVITY remote control compliant with the HACCP norms

## CONNECTIVITY 4.0 & APP

WHEREVER YOU ARE...  
YOUR DISHWASHER, JUST A CLICK AWAY

You will be constantly connected to the machine to monitor the work phases, review any eventual alarm and configure remotely the operating parameters according to your needs. Compliant with HACCP norms. Thanks to our brand new App, you will have access to connected machines and all commercial and technical documentation.

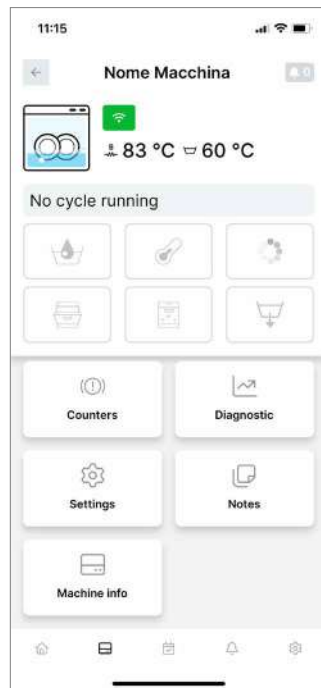

View all the working parameters and historical events, working hours and any problems at any time.



In case of problems, the machine promptly sends an email to you and to the technician who can intervene remotely to solve the problem or equip himself for on-site intervention.



The program allows you to remove an Excel file with all Haccp data at any time.



Discounts are provided for the purchase of 4.0 devices. You will be able to recover 40% of the cost of the car. Request more information to find out more.

## AS OPTION

### AUTOMATIC SHOWER WITH FILTER DRAWER EASY+

Time and energy savings are increased thanks to AS and EASY+, a combined and specific filtering device. Dishes will only need a superficial manual clearing and the automatic shower of the AS module will do a pre-treatment action. (Not available with an installed K10 option).

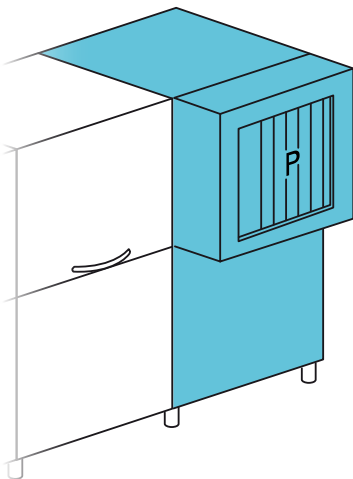
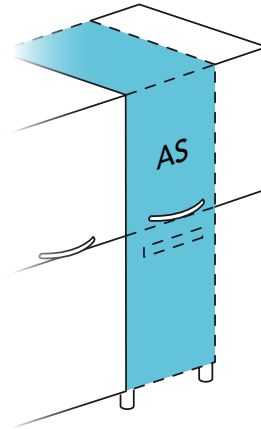

## K10 OPTION

### 90° CORNER PRE-WASH

The design of our 90° corner pre-wash ensures the best solution taking up the minimal amount of space. Smaller dimensions, same productivity (Available on selected models and without AS option).

## HEAT RECOVERY

The heat recovery system allows to supply the machine with cold water\*, ensuring at the same time significant savings in terms of energy consumptions. The steam produced by the machine in operation (otherwise dispersed in the working environment) is aspirated and condensed in the heat exchanger (air –water). The heat produced through this process is transferred to the inlet water, bringing it to a temperature of approximately 45 °C and reducing energy consumptions.

\*inlet water temperature between 8 °C and 15 °C

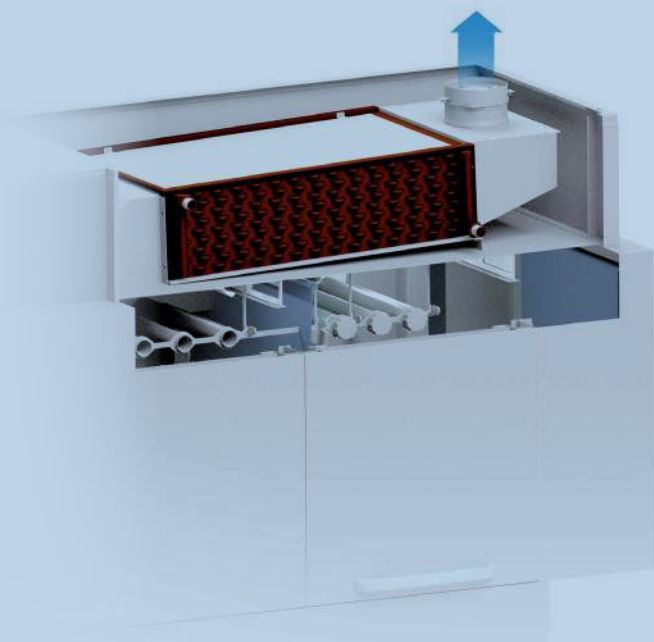

Model  
**RK 2500** 10 SPEEDS

Voltage

Capacity

Dimensions

Code

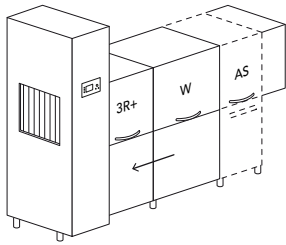

RACK  
EQUIPMENT

- 1 x C40
- 1 x C43
- 1 x C44
- 1 x C47

400 V 3N ~ 50 Hz  
21,08 kW



100\* - 250  
racks / h

2250x920  
2100/2120 H  
350 kg

AS + 450 mm



530x325x25H

**RK 2500**

**RK 2500 AS**

**RK 3000** 10 SPEEDS

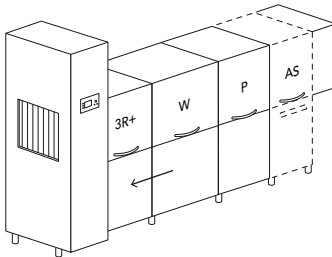

RACK  
EQUIPMENT

- 1 x C40
- 1 x C43
- 1 x C44
- 1 x C47

400 V 3N ~ 50 Hz  
21,98 kW



135\* - 300  
racks / h

2850x920  
2100/2120 H  
510 kg

AS + 450 mm



530x325x25H

**RK 3000**

**RK 3000 AS**

**RK 3000-K10** CORNER PREWASH - 10 SPEEDS

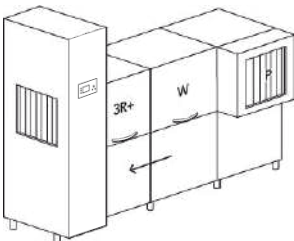

RACK  
EQUIPMENT

- 1 x C40
- 1 x C43/B
- 1 x C44
- 1 x C47

400 V 3N ~ 50 Hz  
21,98 kW



135 - 300  
racks / h

2575x985  
2100/2120 H  
510 kg



530x325x25H

**RK 3000-  
K10**

**RK 3300** 10 SPEEDS

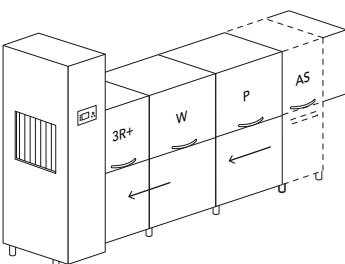

RACK  
EQUIPMENT

- 1 x C40
- 1 x C43
- 1 x C44
- 1 x C47

400 V 3N ~ 50 Hz  
26,26 kW



150 - 330  
racks / h

3150x920  
2100/2120 H  
550 kg











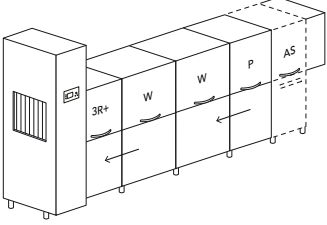

AS + 450 mm

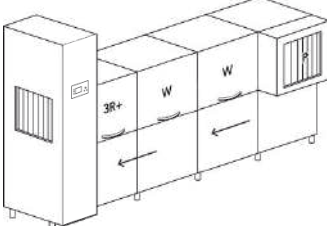

530x325x25H

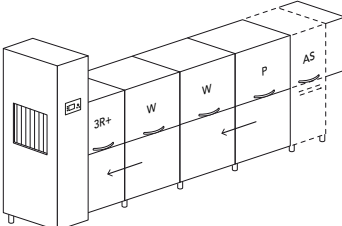
**RK 3300**

**RK 3300 AS**

Model	Voltage	Capacity	Dimensions	Code
<b>RK 3600</b> 10 SPEEDS				
 <p><b>RACK EQUIPMENT</b></p> <ul style="list-style-type: none"> <li>1 x C40</li> <li>1 x C43</li> <li>1 x C44</li> <li>1 x C47</li> </ul>	400 V 3N ~ 50 Hz 37,66 kW	 Ø 450  500x500 190* - 360 racks / h	3750x920 2100/2120 H 710 kg AS + 450 mm  GN 1/1 530x325x25H	<b>RK 3600</b>  <b>RK 3600 AS</b>
<b>RK 3600-K10</b> CORNER PREWASH -10 SPEEDS				
 <p><b>RACK EQUIPMENT</b></p> <ul style="list-style-type: none"> <li>1 x C40</li> <li>1 x C43/B</li> <li>1 x C44</li> <li>1 x C47</li> </ul>	400 V 3N ~ 50 Hz 37,66 kW	 Ø 450  500x500 190* - 360 racks / h	3475x985 2100/2120 H 710 kg  GN 1/1 530x325x25H	<b>RK 3600-K10</b>
<b>RK 4000</b> 10 SPEEDS				
 <p><b>RACK EQUIPMENT</b></p> <ul style="list-style-type: none"> <li>1 x C40</li> <li>1 x C43</li> <li>1 x C44</li> <li>1 x C47</li> </ul>	400 V 3N ~ 50 Hz 40,44 kW	 Ø 450  500x500 210* - 400 racks / h	4050x920 2100/2120 H 750 kg AS + 450 mm  GN 1/1 530x325x25H	<b>RK 4000</b>  <b>RK 4000 AS</b>

- P** Prewash
- W** Wash
- 3R+** Triple reinforced rinse (double pre-rinse + rinse on module)
- K10** Corner prewash
- AS** Automatic shower with filter drawer + 450 mm
- \*** Productivity according to DIN SPEC 10534 regulation ( contact time )

EAC label upon request

Option compatibility to be confirmed by the manufacturer after verification

## OPTIONS

Model	220-240 V 3 50 Hz	380-415 V 3N 50 Hz	60 Hz	PRE DOS KROMO disp. connections	DDE Dispensers kit	DOS/S Dispenser with probe	SAN Sanitization System	PAP-SAN Booster Pump Sanitiz.	DWI Thermoacou- stic insulation	XP Extra Power
<b>RK 2500</b>	€	●	+3%	●	€	€	€	€	●	€
<b>RK 2500 AS</b>	€	●	+3%	●	€	€	€	€	●	€
<b>RK 3000</b>	€	●	+3%	●	€	€	€	€	●	€
<b>RK 3000 AS</b>	€	●	+3%	●	€	€	€	●	●	€
<b>RK 3000-K10</b>	€	●	+3%	●	€	€	€	€	●	€
<b>RK 3300</b>	€	●	+3%	●	€	€	€	€	●	€
<b>RK 3300 AS</b>	€	●	+3%	●	€	€	€	●	●	€
<b>RK 3600</b>	€	●	+3%	●	€	€	€	●	●	€
<b>RK 3600 AS</b>	€	●	+3%	●	€	€	€	●	●	€
<b>RK 3600-K10</b>	€	●	+3%	●	€	€	€	●	●	€
<b>RK 4000</b>	€	●	+3%	●	€	€	€	●	●	€
<b>RK 4000 AS</b>	€	●	+3%	●	€	€	€	●	●	€

- Standard
- DDE-GROUP** Both detergent (with probe) and rinse-aid dispensers included
- DOS/S** For detergent dispenser only
- SAN** Including dosing system for sanitizing product
- PAP-SAN** Supplied AS standard with sanitization option on models:  
RK 3000 AS, RK 3300 AS, RK 3600, RK 3600 AS, RK 3600 K10, RK 4000, RK 4000 AS
- DIV** Compulsory for machines > 4,5 m
- XP** In case of cold water supply for rinse 8 °C 55 °C, and without any heat recovery, the extra power option is mandatory

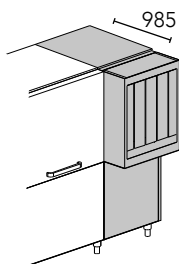
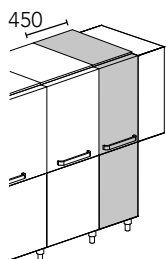

**AS**  
Automatic Shower  
with filter drawer

**K10**  
Corner prewash



	DIV	CONN.	PI	SA	1-DRAIN	AUTOTIMER	PAP	BT	DVGW	ECO-DET	SMART DRIVE+
Model	Price for division	Connectivity (HACCP)	S/S pumps	Automatized Drain	Centralized Drain	Autotimer	Booster pump	Break tank	DVGW	Detergent economizer	Smart drive 10 speeds
<b>RK 2500</b>	€	€	€	€	●	●	●	●	€	●	●
<b>RK 2500 AS</b>	€	€	€	€	●	●	●	●	€	●	●
<b>RK 3000</b>	€	€	€	€	●	●	●	●	€	●	●
<b>RK 3000 AS</b>	€	€	€	€	●	●	●	●	€	●	●
<b>RK 3000-K10</b>	€	€	€	€	●	●	●	●	€	●	●
<b>RK 3300</b>	€	€	€	€	●	●	●	●	€	●	●
<b>RK 3300 AS</b>	€	€	€	€	●	●	●	●	€	●	●
<b>RK 3600</b>	€	€	€	€	●	●	●	●	€	●	●
<b>RK 3600 AS</b>	€	€	€	€	●	●	●	●	€	●	●
<b>RK 3600-K10</b>	€	€	€	€	●	●	●	●	€	●	●
<b>RK 4000</b>	€	€	€	€	●	●	●	●	€	●	●
<b>RK 4000 AS</b>	€	€	€	€	●	●	●	●	€	●	●

**CONNECTIVITY** Includes HACCP option. 10 year plan

**PI** Available with 50 Hz frequency only. Not available for AS module

**DVGW** Not available with heat recovery and steam condenser  
Components prescribed by DVGW on request (check option compatibility with the manufacturer)

In case of cold water supply for rinse (8-15 °C), we recommend to install the heat recovery system optional.

With osmotic water supply and electrical conductivity lower than 200 microsiemens, it is mandatory to install a stainless steel heat exchanger

Water supply 55 °C

We recommend to install the machine in a well ventilated room, with a properly sized steam exhausting system

Standard hints for scheduled maintenance and counters (working hours - water - energy)

Option compatibility to be confirmed by the manufacturer after verification

### AVAILABLE ARCS:

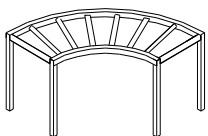

**K 21** 1300x1300x860 H  
90° roller arc with tank

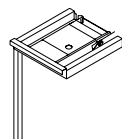

**K 25** 700x610x820 H  
Angle loading table complete with basket pull-through system

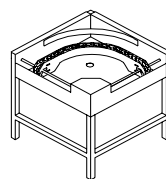

**K 22** 850x850x885 H  
90° motorized arc ( clockwise/ counter-clockwise )

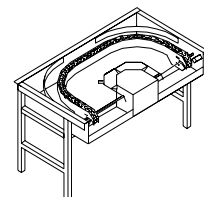

**K 23** 850x1500x885 H  
180° motorized arc ( clockwise/ counter-clockwise )

## OPTIONS

	KLC30	KSC10	KSC15	KHR15	KHR20	KHRP40
Model	Splash guard + 300 mm	Steam condenser	Steam condenser	heat recovery	heat recovery	heat recovery
<b>RK 2500</b>	€	€	€	€	€	€
<b>RK 2500 AS</b>	€	€	€	€	€	€
<b>RK 3000</b>	€	€	€	€	€	€
<b>RK 3000 AS</b>	€	€	€	€	€	€
<b>RK 3000-K10</b>	€	€	€	€	€	€
<b>RK 3300</b>	€	€	€	€	€	€
<b>RK 3300 AS</b>	€	€	€	€	€	€
<b>RK 3600</b>	€	€	€	€	€	€
<b>RK 3600 AS</b>	€	€	€	€	€	€
<b>RK 3600-K10</b>	€	€	€	€	€	€
<b>RK 4000</b>	€	€	€	€	€	€
<b>RK 4000 AS</b>	€	€	€	€	€	€

---- Not available

**KHDR200** Dryer + heat recovery. Fully insulated device. As an alternative KHDRA209M or KHDRA218M

**KHDRA209M** Dryer + heat recovery on 90° motorized arc. Fully insulated device.  
As an alternative KHDR200 or KHDRA218M

**KHDRA218M** Dryer + heat recovery on 90° motorized arc. Fully insulated device.  
As an alternative KHDR200 or KHDRA209M. Mandatory division

**+** Not available for K10 version if the machine is next to the wall

In case of cold water supply for rinse (8-15 °C), we recommend to install the heat recovery system optional.

With osmotic water supply and electrical conductivity lower than 200 microsiemens, it is mandatory to install a stainless steel heat exchanger

Water supply 55 °C

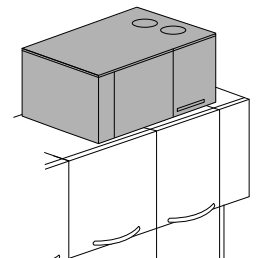
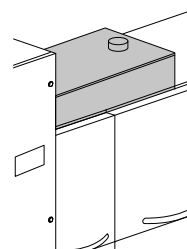
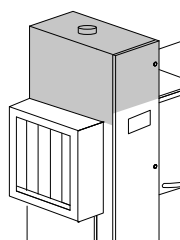
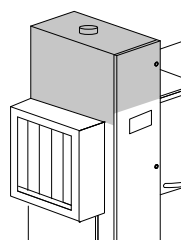
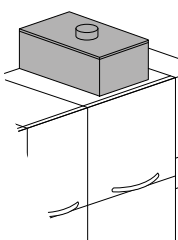

**KSC10**

Steam condenser

**KSC15**

Steam condenser

**KHR15**

Compact heat recovery

**KHR20**

heat recovery

**KHRP40**



Heat recovery with heat pump

Model	KHDR200	KHDRA209M	KHDRA218M	KDR204	KDR209	KDRA99MT	KDRA189MT
	Dryer + heat recovery	Dryer + heat recovery	Dryer + heat recovery	Dryer	Insulated Dryer	Motorized dryer 90° arc	Motorized dryer 180° arc
<b>RK 2500</b>	€	€	€	€	€	€	€
<b>RK 2500 AS</b>	€	€	€	€	€	€	€
<b>RK 3000</b>	€	€	€	€	€	€	€
<b>RK 3000 AS</b>	€	€	€	€	€	€	€
<b>RK 3000-K10</b>	€	€	€	€	€	€	€
<b>RK 3300</b>	€	€	€	€	€	€	€
<b>RK 3300 AS</b>	€	€	€	€	€	€	€
<b>RK 3600</b>	€	€	€	€	€	€	€
<b>RK 3600 AS</b>	€	€	€	€	€	€	€
<b>RK 3600-K10</b>	€	€	€	€	€	€	€
<b>RK 4000</b>	€	€	€	€	€	€	€
<b>RK 4000 AS</b>	€	€	€	€	€	€	€

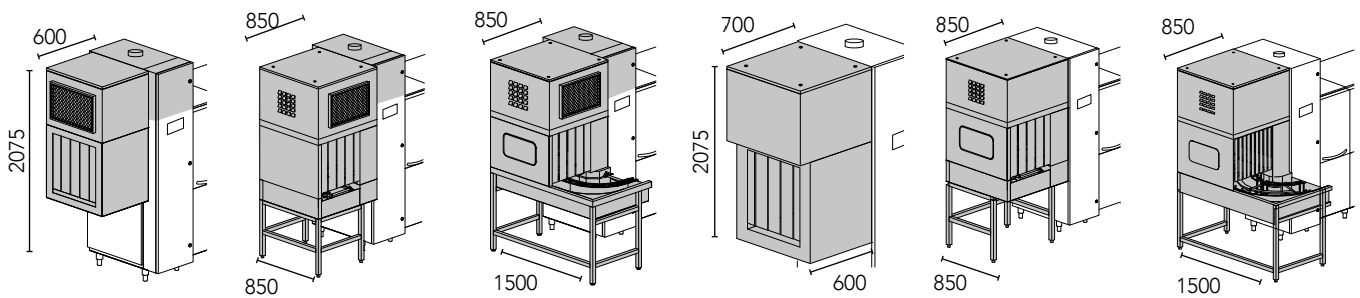
- KSC10** Available only with optional dryer
  - KSC15** Not available with optional dryer
  - KHR20** As an alternative KHR15 or KHRP40.
  - KHRP40** Available with 400 V 3N 50 Hz frequency only
  - KHR15-KHR20-KHRP40** In case of cold water supply for rinse (8-15 °C), we recommend to install the heat recovery system optional.
  - KDR204** Not recommended for models RK 3000, RK 3300, RK 3600, RK 4000. Verify with manufacturer
  - KDRA99MT - KDRA189MT** Mandatory division
- Option compatibility to be confirmed by the manufacturer after verification

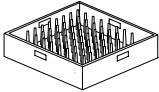
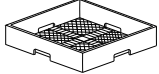
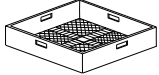
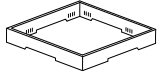
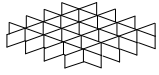
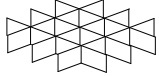
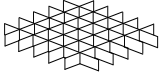
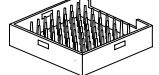
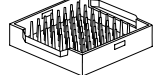
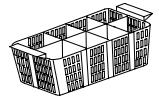

<b>KHDR200</b> 4,5kW Electric Dryer + Heat Recovery	<b>KHDRA209M</b> 4,5kW Electric Dryer on 90° motorized arc + Heat Recovery	<b>KHDRA218M</b> 4,5kW Electric Dryer on 180° motorized arc + Heat Recovery	<b>KDR204</b> 4,5kW <b>KDR209</b> 9 kW Insulated Dryer	<b>KDRA99MT</b> 9 kW Dryer with motorized arc 90°	<b>KDRA189MT</b> 9 kW Dryer with motorized arc 180°
---	---	--	--	---	---

	Description	Capacity	Dimensions	Code	
	PLATE BASKET	18 plates	500x500x105 H	<b>C 40</b>	
	NARROW MESH CUTLERY BASKET		500x500x106 H	<b>C 41</b>	
	LARGE MESH BASKET	For glasses	500x500x105 H	<b>C 44</b>	
	HOLDER FOR GLASS SUPPORT	For glass support (C112-C113-C114)	500x500x50 H	<b>C 111</b>	
	GLASS SUPPORT	5x5 Glass Ø 87 mm (C111)	500x500x50 H	<b>C 112</b>	
	GLASS SUPPORT	4x4 Glass Ø 110 mm (C111)	500x500x50 H	<b>C 113</b>	
	GLASS SUPPORT	6x6 Glass Ø 72 mm (C111)	500x500x50 H	<b>C 114</b>	
	TRAYS BASKET	8 pcs, max. depth 25 mm	500x500x105 H	<b>C 43</b>	
	GASTRONORM TRAYS BASKET GN 1/1	6 pcs, max. depth 25 mm	500x500x105 H	<b>C 43/B</b>	
	CUTLERY BASKET		490x180x140 H	<b>C 47</b>	
	FLEXIBLE SHOWER complete with mixing group and lever tap, to be fixed to the wall		1000 H	<b>K 1</b>	
	FLEXIBLE SHOWER complete with mixing group and lever tap, to be fixed to the wall and intermediate tap		1000 H	<b>K 1HR</b>	

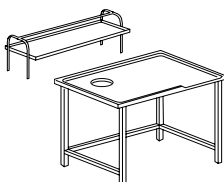
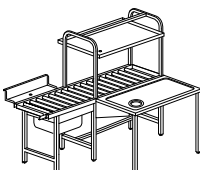
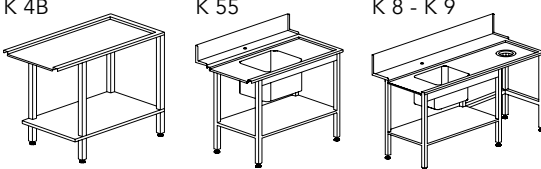
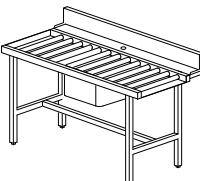
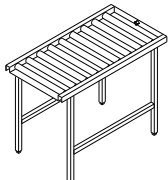
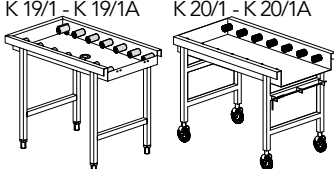
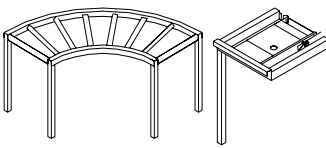
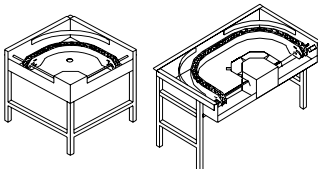
	Description	Capacity	Dimensions	Code
	SHELF		1515x620x660 H	<b>K 7M16*</b>
			2315x620x660 H	<b>K 7M24*</b>
	GRADING TABLE WITH RUBBER RING	Waste hole and special dimensions upon request	1600x1000x850 H	<b>K 7A/1600*</b>
			2400x1000x850 H	<b>K 7A/2400*</b>
	MECHANIZED GRADING TABLE With mechanized basket advancement system	1 waste hole	1800x1240 1525 H	<b>K M7/1800*</b>
		2 waste hole	2400x1240 1525 H	<b>K M7/2400*</b>
			1200x590x860 H	<b>K 4B</b>
			1200x730x860 H	<b>K 55</b>
		Standard rubber ring	1500x730x860 H	<b>K 8</b>
		Standard rubber ring	1800x730x860 H	<b>K 9</b>
	ROLLER TABLE + sink, right or left version		1600x730x860 H	<b>K 195</b>
	Sink 500x400x270 H			
	LINEAR ROLLER TABLE WITH TANK		1100x650x860 H	<b>K 19*</b>
			1600x650x860 H	<b>K 19/B*</b>
			2100x650x860 H	<b>K 19/C*</b>
		Option end microswitch		<b>K 18</b>
	LINEAR ROLLER TABLE WITH TANK complete with end microswitch	Not compatible with same references Not on 180° arcs	1100x650x860 H	<b>K 19/1</b>
			1600x650x860 H	<b>K 19/1A</b>
		To be connected to KM23 only and to dryer on 180°	1150x650x860 H	<b>K 20/1</b>
			1650x650x860 H	<b>K 20/1A</b>
	90°roller arc with tank (exit only with roller table)		1300x1300x860 H	<b>K 21*</b>
	ANGLE LOADING TABLE complete with basket pull-through system	Optional connection to prewash tables	700x610x820 H	<b>K 25</b>
	90° MOTORIZED ARC ( clockwise/counter-clockwise )		850x850x885 H	<b>K 22*</b>
	180° MOTORIZED ARC ( clockwise/counter-clockwise )		850x1500x885 H	<b>K 23*</b>

\* Wooden cage +2% minimum + € / Special dimensions for tables upon request / Tables shown in right-to-left version

We strongly recommend the presence of a roller table with end microswitch at the exit of our rack type machines for a correct operation



Big news at KROMO!

We are happy to introduce the “Green” QK LUX! This range has been enhanced and rewarded with the SMART LABEL HOST 2023 award for its functional efficiency. Thanks to innovative pre-rinse and rinse arms, we have achieved exceptional results while maintaining the same performance: 35% water savings compared to previous versions! Added to this innovation is the introduction of new options, including a renewed triple rinse, with osmotic water supply on request, and an improved drying system, which make them flexible, complete and first-class flight-type conveyor dishwashers. As you know, our goal is to minimize the use of envi-

ronmental resources but also your operating costs. Features such as the detergent economizer, the concept of thermal insulation, the CPF system and the double reinforced rinse show KROMO's wish to progress in the search for innovative solutions, ever more profitable and environmental friendly. As always, the KROMO flight-type conveyor dishwashers are available in multiple versions that can be combined with our other ranges (tray washers, rack conveyor dishwashers, transportation systems, etc). Our washing solutions, increasingly efficient over the years, adjust to different requirements while guaranteeing high hygiene standards to ensure optimal sanitation.

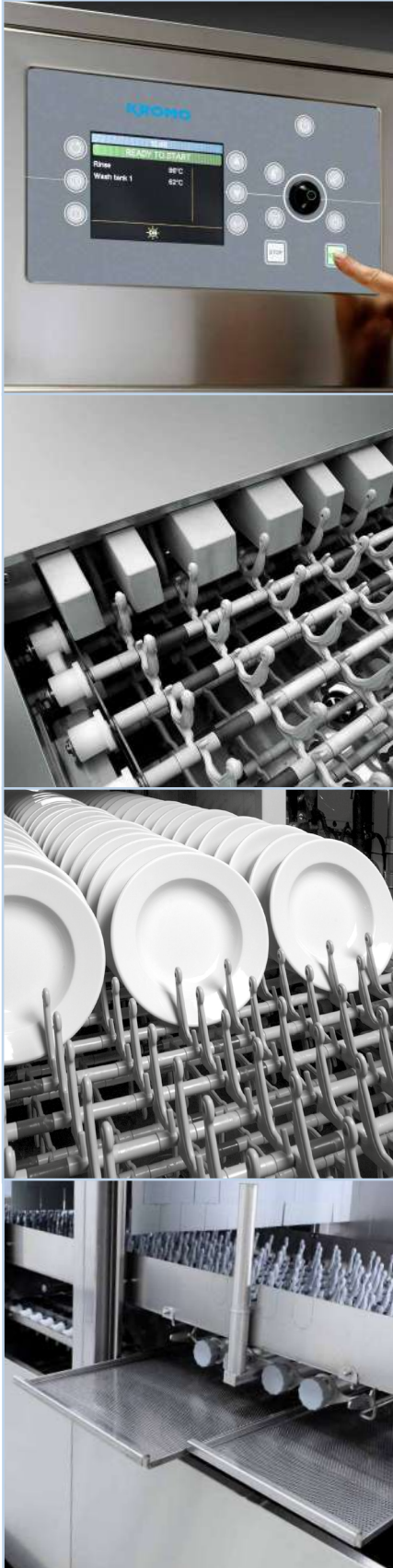

## FEATURES

### STANDARD

- SMART DRIVE 5 speed advancement system
- 710 mm wide conveyor
- Plates belt
- TFT 5.7" display and soft touch keyboard
- Frequently used keys shortcut and menu language setting
- Constant monitoring of key operations
- IPX5 electronic board
- Alarms and events report
- Autotimer
- Centralized 1-DRAIN and automatic AD drain, with total or partial emptying of the tanks
- Wash arms ALL-IN-1
- Use economizer
- ECO-DET detergent economizer
- ACID PROOF radial wash tanks in S/S AISI 316 inclined to provide complete drainage of the wash water
- S/S surface filters CLEAN+ to protect the wash tanks as well as the wash pump
- Double-skin, insulated and counterbalanced doors, equipped with anti-drop safety system
- THERMO BARRIER system for comfort in use
- Predisposition for KROMO rinse-aid and detergent dispensers connection
- Non return valve
- ACID PROOF stainless steel boilers in AISI 316, fully insulated to reduce thermal loss.
- Vertical self-cleaning pumps
-  Reinforced double rinse 2R+, improved efficiency with lower consumption
- CPF System: Controlled Pressure Flow
- Water, energy consumptions and working time control system
- Possible working modes for dryer unit: all off, only fan, half power 4,5 kW + fan, total power 9 kW + fan

## OPTIONS



- Five different conveyor belts available, also with cutlery lane
- Different types of dryers: double skin dryer on module (with or without turboblowers) or on shelf (double skin on request)
- **NEW:** Double skin lateral dryer on shelf: innovative system with upper fan for improved drying results
- Steam condenser
- Three models of heat recovery to be chosen
- **NEW:** Triple reinforced rinse 3R+ for drastically reduced water consumption (with reverse osmosis water on separate module on request)
- AS6 Automatic shower with EASY+ with filter system
- Dispensers kit with peristaltic pump, for detergent as well as rinse-aid
- CONNECTIVITY remote control compliant with the HACCP norms (on request)
- Delivery in two or more parts, to ease installation operations
- Automatic self-cleaning of the machine available, with dedicated booster pump on request
- Tank insulation
- Break tank and booster pump
- Dedicated space for detergent and rinse-aid jugs
- S/S pumps
- Extra power in the boiler

## STANDARD BELTS

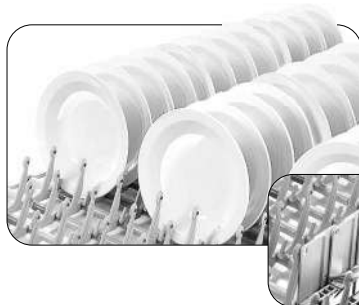

Standard belt for plates and optional cutlery lane



Standard belt for glasses



Standard belt for trays and utensils

## OPTIONAL BELTS



Special belt for hospitals



Special belt for thermal trays



Special belt for in-flight catering



## CONNECTIVITY 4.0 & APP

WHEREVER YOU ARE...  
YOUR DISHWASHER, JUST A CLICK AWAY

You will be constantly connected to the machine to monitor the work phases, review any eventual alarm and configure remotely the operating parameters according to your needs. Compliant with HACCP norms. Thanks to our brand new App, you will have access to connected machines and all commercial and technical documentation.

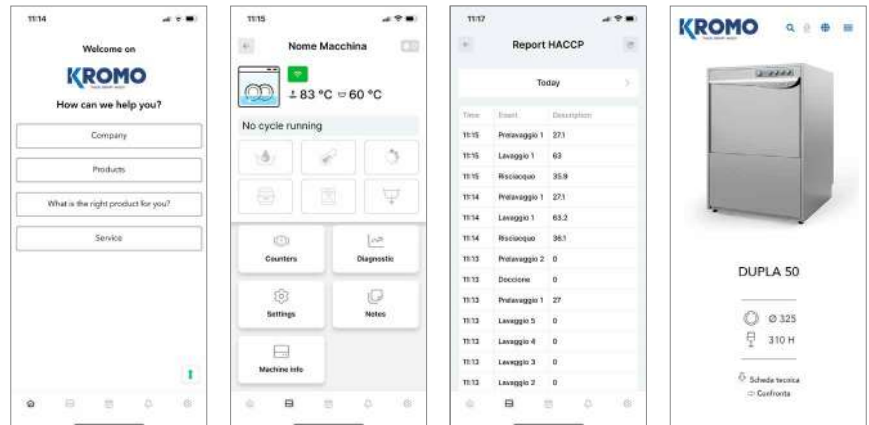

## SMART LABEL HOST 2023 FOR FUNCTIONAL EFFICIENCY

According to the KROMO's sustainability vision and attention to customer operating costs, the QK range of flight conveyor dishwashers has been renewed. The result is a great reduction in water consumption: more than 35% when compared to the previous version, an important figure in today's environmental and economic needs. To do so, new rinse and pre-rinse arms and ramps have been designed to achieve one of the lowest consumption levels in our sector. With lower water, KROMO continues to ensure high quality rinsing results. Indeed, a higher washing pressure guarantees optimal results with the removal of all the chemicals present on the dishes. Such reduction of water also means significant savings in terms of detergent and energy, that have become very high expenditure items.



View all the working parameters and event records, working hours and any problem at any time.











In case of problem, the machine promptly alerts you. The technician can intervene remotely to solve the problem or anticipate the needed parts for an on-site intervention.

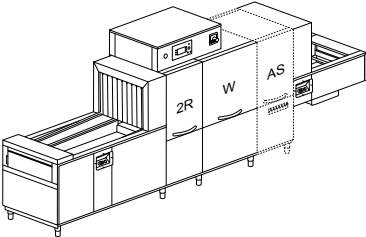

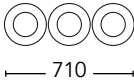
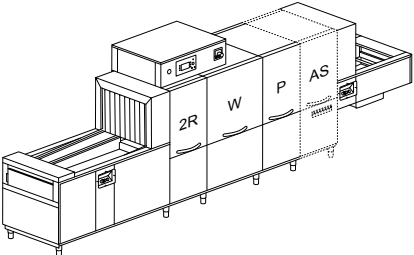

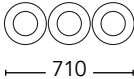
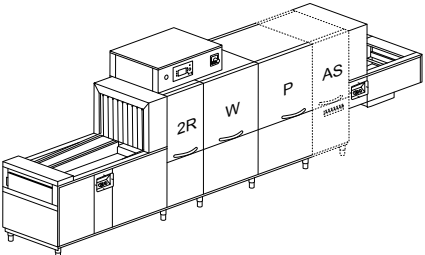

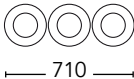
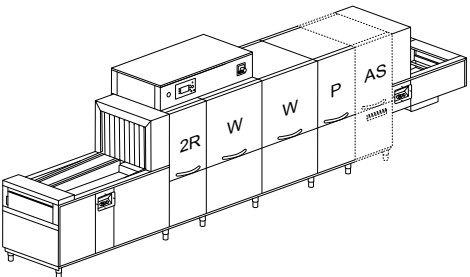

A daily activity report is available with all the events related to the dishwasher in a detailed spreadsheet with HACCP data.

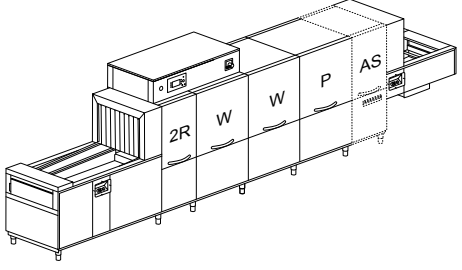

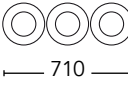
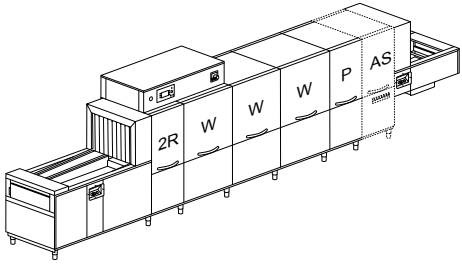
Our Connectivity system is a revolutionary device limiting and facilitating the eventual intervention of a technician who can anticipate the necessary parts to be replaced, saving time and money.

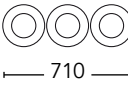
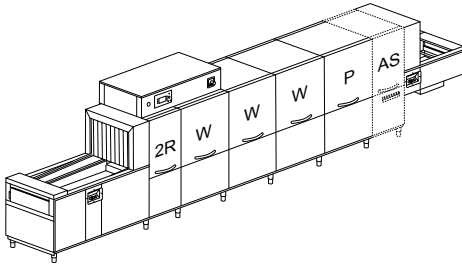
Model	Voltage	Capacity	Dimensions	Code
<b>QK 2460</b> 5 SPEEDS				
<i>IMPROVED</i>				
	400 V 3N ~ 50 Hz 27 kW	 450 H	4500x985 1860/2200H 595 kg	<b>QK 2460</b>
	400 V 3N ~ 50 Hz 2,5 kW 17 kg/h	 710		<b>QK 2460 AS6</b>
		1950 / 3690 dishes / h	AS6 +600 mm	<b>QK 2460 V</b>
		2400* dishes / h		<b>QK 2460 V AS6</b>
<b>QK 3760</b> 5 SPEEDS				
<i>IMPROVED</i>				
	400 V 3N ~ 50 Hz 29,45 kW	 450 H	5100x985 1860/2200H 730 kg	<b>QK 3760</b>
	400 V 3N ~ 50 Hz 3,45 kW 20 kg/h	 710		<b>QK 3760 AS6</b>
		2400 / 4050 dishes / h	AS6 +600 mm	<b>QK 3760 V</b>
		3300* dishes / h		<b>QK 3760 V AS6</b>
<b>QK 4160</b> 5 SPEEDS				
<i>IMPROVED</i>				
	400 V 3N ~ 50 Hz 33,5 kW	 450 H	5400x985 1860/2200H 745 kg	<b>QK 4160</b>
	400 V3N ~ 50 Hz 4,5 kW 25 kg/h	 710		<b>QK 4160 AS6</b>
		3000 / 4800 dishes / h	AS6 +600 mm	<b>QK 4160 V</b>
		3750* dishes / h		<b>QK 4160 V AS6</b>
<b>QK 5360</b> 5 SPEEDS				
<i>IMPROVED</i>				
	400 V3N ~ 50 Hz 49,45 kW	 450 H	6000x985x 860/2200H 880 kg	<b>QK 5360</b>
	400 V 3N ~ 50 Hz 5,45 kW 29 kg/h	 710		<b>QK 5360 AS6</b>
		4200 / 6450 dishes / h	AS6 +600 mm	<b>QK 5360 V</b>
		4650* dishes / h		<b>QK 5360 V AS6</b>

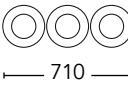
Model	Voltage	Capacity	Dimensions	Code
<b>QK 5960</b> 5 SPEEDS				
<i>IMPROVED</i>				
	400 V 3N ~ 50 Hz 53,5 kW	 450 H	6300x985 1860/2200H 895 kg	<b>QK 5960</b>
		 710		<b>QK 5960 AS6</b>
	400 V 3N ~ 50 Hz 6,5 kW 34 kg/h	4350 / 6750 dishes / h	AS6 +600 mm	<b>QK 5960 V</b>
		5100* dishes / h		<b>QK 5960 V AS6</b>
<b>QK 6760</b> 5 SPEEDS				
<i>IMPROVED</i>				
	400 V 3N ~ 50 Hz 69,45 kW	 450 H	7300x985 1860/2200H 1030 kg	<b>QK 6760</b>
		 710		<b>QK 6760 AS6</b>
	400 V 3N ~ 50 Hz 7,45 kW 39 kg/h	5250 / 8100 dishes / h	AS6 +600 mm	<b>QK 6760 V</b>
		6000* dishes / h		<b>QK 6760 V AS6</b>
<b>QK 7760</b> 5 SPEEDS				
<i>IMPROVED</i>				
	400 V 3N ~ 50 Hz 72,5 kW	 450 H	7600x985 1860/2200H 1045 kg	<b>QK 7760</b>
		 710		<b>QK 7760 AS6</b>
	400 V 3N ~ 50 Hz 8,5 kW 43 kg/h	5850 / 9000 dishes / h	AS6 +600 mm	<b>QK 7760 V</b>
		6450* dishes / h		<b>QK 7760 V AS6</b>

- P** Prewash
- W** Wash
- 2R** Double reinforced rinse (pre-rinse + rinse on module)
- 3R+** Reinforced triple rinse with low water consumption: double pre-rinse + rinse on module (reverse osmosis on request)
- AS6** Automatic shower with filter drawer +600 mm
- V** Steam-heated
- \*** Productivity according to DIN SPEC 10534 regulation ( contact time )

EAC label upon request

Option compatibility to be confirmed by the manufacturer after verification

## OPTIONS

	220-240 V 3 50 Hz	380-415 V 3N 50 Hz	60 Hz	AUTOTIMER Autotimer	PRE DOS Kromo disp. connections	DDE-GROUP Dispensers kit	DOS/S Dispenser with probe	SAN Sanitization System
<b>QK 2460</b>	+ 2%	●	+ 3%	●	●	€	€	€
<b>QK 2460 AS6</b>	+ 2%	●	+ 3%	●	●	€	€	€
<b>QK 2460 V</b>	+ 1%	●	+ 3%	●	●	€	€	€
<b>QK 2460 AS6 V</b>	+ 1%	●	+ 3%	●	●	€	€	€
<b>QK 3760</b>	+ 2%	●	+ 3%	●	●	€	€	€
<b>QK 3760 AS6</b>	+ 2%	●	+ 3%	●	●	€	€	€
<b>QK 3760 V</b>	+ 1%	●	+ 3%	●	●	€	€	€
<b>QK 3760 AS6 V</b>	+ 1%	●	+ 3%	●	●	€	€	€
<b>QK 4160</b>	+ 2%	●	+ 3%	●	●	€	€	€
<b>QK 4160 AS6</b>	+ 2%	●	+ 3%	●	●	€	€	€
<b>QK 4160 V</b>	+ 1%	●	+ 3%	●	●	€	€	€
<b>QK 4160 AS6 V</b>	+ 1%	●	+ 3%	●	●	€	€	€
<b>QK 5360</b>	+ 2%	●	+ 3%	●	●	€	€	€
<b>QK 5360 AS6</b>	+ 2%	●	+ 3%	●	●	€	€	€
<b>QK 5360 V</b>	+ 1%	●	+ 3%	●	●	€	€	€
<b>QK 5360 AS6 V</b>	+ 1%	●	+ 3%	●	●	€	€	€
<b>QK 5960</b>	+ 2%	●	+ 3%	●	●	€	€	€
<b>QK 5960 AS6</b>	+ 2%	●	+ 3%	●	●	€	€	€
<b>QK 5960 V</b>	+ 1%	●	+ 3%	●	●	€	€	€
<b>QK 5960 AS6 V</b>	+ 1%	●	+ 3%	●	●	€	€	€
<b>QK 6760</b>	+ 2%	●	+ 3%	●	●	€	€	€
<b>QK 6760 AS6</b>	+ 2%	●	+ 3%	●	●	€	€	€
<b>QK 6760 V</b>	+ 1%	●	+ 3%	●	●	€	€	€
<b>QK 6760 AS6 V</b>	+ 1%	●	+ 3%	●	●	€	€	€
<b>QK 7760</b>	+ 2%	●	+ 3%	●	●	€	€	€
<b>QK 7760 AS6</b>	+ 2%	●	+ 3%	●	●	€	€	€
<b>QK 7760 V</b>	+ 1%	●	+ 3%	●	●	€	€	€
<b>QK 7760 AS6 V</b>	+ 1%	●	+ 3%	●	●	€	€	€

● Standard

□ Upon request

**DDE-GROUP** Both detergent (with probe) and rinse-aid dispensers included

**DWI** Insulation option for the tunnel only, dryer excluded. Shelf dryer can be double skin upon request

	PAP-SAN	DWI	DWI / T	CONNECTIVITY	XP	PAP	SMART DRIVE
	Booster Pump Sanitiz.	Thermoacoustic insulation	Tank insulation	Connectivity (HACCP)	Extra Power	Booster pump	Smart drive 5 speeds
<b>QK 2460</b>	€	€	€	€	€	€	●
<b>QK 2460 AS6</b>	€	€	€	€	€	€	●
<b>QK 2460 V</b>	€	€	€	€	□	€	●
<b>QK 2460 AS6 V</b>	€	€	€	€	□	€	●
<b>QK 3760</b>	€	€	€	€	€	€	●
<b>QK 3760 AS6</b>	●	€	€	€	€	€	●
<b>QK 3760 V</b>	€	€	€	€	□	€	●
<b>QK 3760 AS6 V</b>	●	€	€	€	□	€	●
<b>QK 4160</b>	€	€	€	€	€	€	●
<b>QK 4160 AS6</b>	●	€	€	€	€	€	●
<b>QK 4160 V</b>	€	€	€	€	□	€	●
<b>QK 4160 AS6 V</b>	●	€	€	€	□	€	●
<b>QK 5360</b>	●	€	€	€	€	€	●
<b>QK 5360 AS6</b>	●	€	€	€	€	€	●
<b>QK 5360 V</b>	●	€	€	€	€	€	●
<b>QK 5360 AS6 V</b>	●	€	€	€	€	€	●
<b>QK 5960</b>	●	€	€	€	€	€	●
<b>QK 5960 AS6</b>	●	€	€	€	€	€	●
<b>QK 5960 V</b>	●	€	€	€	€	€	●
<b>QK 5960 AS6 V</b>	●	€	€	€	€	€	●
<b>QK 6760</b>	●	€	€	€	€	€	●
<b>QK 6760 AS6</b>	●	€	€	€	€	€	●
<b>QK 6760 V</b>	●	€	€	€	€	€	●
<b>QK 6760 AS6 V</b>	●	€	€	€	€	€	●
<b>QK 7760</b>	●	€	€	€	€	€	●
<b>QK 7760 AS6</b>	●	€	€	€	€	€	●
<b>QK 7760 V</b>	●	€	€	€	□	€	●
<b>QK 7760 AS6 V</b>	●	€	€	€	□	€	●

**DWI - DWI/T** Recommended with KHR10 – KHR20 – KHRP40

**CONNECTIVITY** Includes HACCP option. 10 year plan

**PAP-SAN** One standard pump for models QK 5360, QK 5960, QK 6760, QK 7760

**XP** In case of cold water supply for rinse 8 °C 55 °C, and without any heat recovery, the extra power option is mandatory  
In case of cold water supply for rinse (8-15 °C), we recommend to install the heat recovery system optional.

Option compatibility to be confirmed by the manufacturer after verification

## OPTIONS

Model	Master switch	Surface filters	Peak-cut for Kromo dosing	Estimated consumption readout	PI	1-DRAIN
					S/S pumps	Centralized Drain
QK 2460	●	●	●	●	€	●
QK 2460 AS6	●	●	●	●	€	●
QK 2460 V	●	●	●	●	€	●
QK 2460 AS6 V	●	●	●	●	€	●
QK 3760	●	●	●	●	€	●
QK 3760 AS6	●	●	●	●	€	●
QK 3760 V	●	●	●	●	€	●
QK 3760 AS6 V	●	●	●	●	€	●
QK 4160	●	●	●	●	€	●
QK 4160 AS6	●	●	●	●	€	●
QK 4160 V	●	●	●	●	€	●
QK 4160 AS6 V	●	●	●	●	€	●
QK 5360	●	●	●	●	€	●
QK 5360 AS6	●	●	●	●	€	●
QK 5360 V	●	●	●	●	€	●
QK 5360 AS6 V	●	●	●	●	€	●
QK 5960	●	●	●	●	€	●
QK 5960 AS6	●	●	●	●	€	●
QK 5960 V	●	●	●	●	€	●
QK 5960 AS6 V	●	●	●	●	€	●
QK 6760	●	●	●	●	€	●
QK 6760 AS6	●	●	●	●	€	●
QK 6760 V	●	●	●	●	€	●
QK 6760 AS6 V	●	●	●	●	€	●
QK 7760	●	●	●	●	€	●
QK 7760 AS6	●	●	●	●	€	●
QK 7760 V	●	●	●	●	€	●
QK 7760 AS6 V	●	●	●	●	€	●

● Standard

---- Not available

**LANE** Only with KDRF69 - KDRF6V

**DIV** Compulsory for machines > 4,5 m

**BT** Booster pump included

**DVGW** Not available with heat recovery and steam condenser  
Components prescribed by DVGW on request (check option compatibility with the manufacturer)

	AD	ECO-DET	X-BELT	LANE	DIV	BT	DVGW
Model	Automatic drain	Detergent economizer	Special belt	Cutlery lane	Price for division	Break tank	DVGW
<b>QK 2460</b>	●	●	+ 7 %	----	€	€	€
<b>QK 2460 AS6</b>	●	●	+ 7 %	----	€	€	€
<b>QK 2460 V</b>	●	●	+ 7 %	----	€	€	€
<b>QK 2460 AS6 V</b>	●	●	+ 7 %	----	€	€	€
<b>QK 3760</b>	●	●	+ 7 %	----	€	€	€
<b>QK 3760 AS6</b>	●	●	+ 7 %	----	€	€	€
<b>QK 3760 V</b>	●	●	+ 7 %	----	€	€	€
<b>QK 3760 AS6 V</b>	●	●	+ 7 %	----	€	€	€
<b>QK 4160</b>	●	●	+ 7 %	+ 5 %	€	€	€
<b>QK 4160 AS6</b>	●	●	+ 7 %	----	€	€	€
<b>QK 4160 V</b>	●	●	+ 7 %	+ 5 %	€	€	€
<b>QK 4160 AS6 V</b>	●	●	+ 7 %	----	€	€	€
<b>QK 5360</b>	●	●	+ 7 %	----	€	€	€
<b>QK 5360 AS6</b>	●	●	+ 7 %	----	€	€	€
<b>QK 5360 V</b>	●	●	+ 7 %	----	€	€	€
<b>QK 5360 AS6 V</b>	●	●	+ 7 %	----	€	€	€
<b>QK 5960</b>	●	●	+ 7 %	+ 5 %	€	€	€
<b>QK 5960 AS6</b>	●	●	+ 7 %	----	€	€	€
<b>QK 5960 V</b>	●	●	+ 7 %	+ 5 %	€	€	€
<b>QK 5960 AS6 V</b>	●	●	+ 7 %	----	€	€	€
<b>QK 6760</b>	●	●	+ 7 %	----	€	€	€
<b>QK 6760 AS6</b>	●	●	+ 7 %	----	€	€	€
<b>QK 6760 V</b>	●	●	+ 7 %	----	€	€	€
<b>QK 6760 AS6 V</b>	●	●	+ 7 %	----	€	€	€
<b>QK 7760</b>	●	●	+ 7 %	+ 5 %	€	€	€
<b>QK 7760 AS6</b>	●	●	+ 7 %	----	€	€	€
<b>QK 7760 V</b>	●	●	+ 7 %	+ 5 %	€	€	€
<b>QK 7760 AS6 V</b>	●	●	+ 7 %	----	€	€	€

Option compatibility to be confirmed by the manufacturer after verification

## OPTIONS

Model	NZ3 Neutral zone 300	NZ6 Neutral zone 600	NZH6 Neutral zone for dryer 600	KDRF69 Shelf dryer	KDRF6V Steam-heated shelf dryer	ID Double skin for dryer	KDRF70 Shelf dryer	KDRF9V Steam-heated shelf dryer	KDRF99M Stage Dryer	KDRF9VM Steam heated stage dryer
<b>QK 2460 - QK 2460 AS6</b>	€	€	€	€	----	€	€	----	€	----
<b>QK 2460 V - QK 2460 AS6 V</b>	€	€	€	€	€	€	€	€	€	€
<b>QK 3760 - QK 3760 AS6</b>	€	€	€	€	----	€	€	----	€	----
<b>QK 3760 V - QK 3760 AS6 V</b>	€	€	€	€	€	€	€	€	€	€
<b>QK 4160 - QK 4160 AS6</b>	€	€	€	€	----	€	€	----	€	----
<b>QK 4160 V - QK 4160 AS6 V</b>	€	€	€	€	€	€	€	€	€	€
<b>QK 5360 - QK 5360 AS6</b>	€	€	€	€	----	€	€	----	€	----
<b>QK 5360 V - QK 5360 AS6 V</b>	€	€	€	€	€	€	€	€	€	€
<b>QK 5960 - QK 5960 AS6</b>	€	€	€	€	----	€	€	----	€	----
<b>QK 5960 V - QK 5960 AS6 V</b>	€	€	€	€	€	€	€	€	€	€
<b>QK 6760 - QK 6760 AS6</b>	€	€	€	€	----	€	€	----	€	----
<b>QK 6760 V - QK 6760 AS6 V</b>	€	€	€	€	€	€	€	€	€	€
<b>QK 7760 - QK 7760 AS6</b>	€	€	€	€	----	€	€	----	€	----
<b>QK 7760 V - QK 7760 AS6 V</b>	€	€	€	€	€	€	€	€	€	€

---- Not available

\* Available only with AS6

**NZ3** Recommended with big quantities of trays to wash

**NZ6** Recommended for big quantities of trays to wash. Module equipped with a front door

**NZH6** Recommended with dryers with blowers

**ID** Recommended for KDRF69 - KDRF6V. Only for shelf dryer

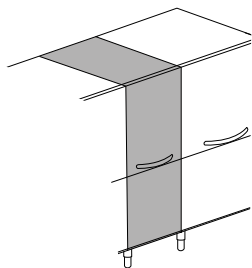

**NZ3** + 300 mm  
Neutral zone

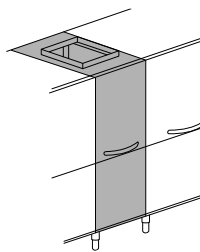

**NZ6** + 600 mm  
Neutral zone with door

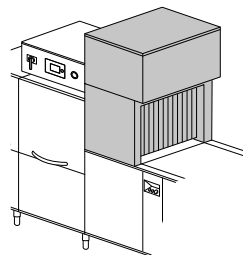

**KDRF69** 9 kW  
Shelf dryer

**KDRF6V**  
Steam heated shelf dryer

**KDRF70**  
Double skin lateral shelf dryer with upper fan

**KDRF7V**  
Steam-heated double skin shelf lateral dryer  
with upper fan

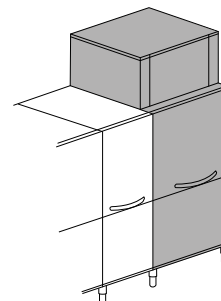

**KDRF99M** + 900 mm - 9 kW  
Dryer module

**KDRF9VM** + 900 mm  
Steam heated dryer module



Model	KDRF99MB	KDRF9VMB	KSCF10	KHRF10	KHRF20	KHRPF40	3R+	3R+ RO	STOCK
	Stage dryer with blowers	Steam heated stage dryer with blowers	Steam condenser	Heat recovery	Heat recovery	Heat recovery	Triple reinforced rinse	Triple reinforced rinse with RO	Chemicals compartment
<b>QK 2460 - QK 2460 AS6</b>	€	----	€	€	€ *	€ *	€	€	€
<b>QK 2460 V - QK 2460 AS6 V</b>	€	€	€	€	€ *	€ *	€	€	€
<b>QK 3760 - QK 3760 AS6</b>	€	----	€	€	€	€	€	€	€
<b>QK 3760 V - QK 3760 AS6 V</b>	€	€	€	€	€	€	€	€	€
<b>QK 4160 - QK 4160 AS6</b>	€	----	€	€	€	€	€	€	€
<b>QK 4160 V - QK 4160 AS6 V</b>	€	€	€	€	€	€	€	€	€
<b>QK 5360 - QK 5360 AS6</b>	€	----	€	€	€	€	€	€	€
<b>QK 5360 V - QK 5360 AS6 V</b>	€	€	€	€	€	€	€	€	€
<b>QK 5960 - QK 5960 AS6</b>	€	----	€	€	€	€	€	€	€
<b>QK 5960 V - QK 5960 AS6 V</b>	€	€	€	€	€	€	€	€	€
<b>QK 6760 - QK 6760 AS6</b>	€	----	€	€	€	€	€	€	€
<b>QK 6760 V - QK 6760 AS6 V</b>	€	€	€	€	€	€	€	€	€
<b>QK 7760 - QK 7760 AS6</b>	€	----	€	€	€	€	€	€	€
<b>QK 7760 V - QK 7760 AS6 V</b>	€	€	€	€	€	€	€	€	€

**KDRF99M - KDRF9VM**

Module with front door

**3R+**

Reinforced triple rinse: Improved consumptions (with reverse osmosis water on request).

**KHRF10 - KHRF20 - KHRPF40**

In case of cold water supply for rinse (8-15 °C), we recommend to install the heat recovery system optional.

With osmotic water supply and electrical conductivity lower than 200 microsiemens, it is mandatory to install a stainless steel heat exchanger

Option compatibility to be confirmed by the manufacturer after verification

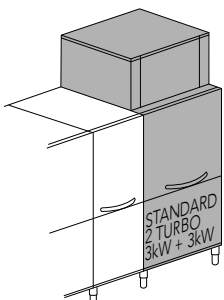

**KDRF99MB** + 900 mm - 15 kW

Dryer module

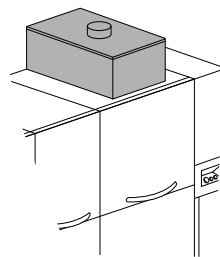

**KHRF10**

Compact heat recovery

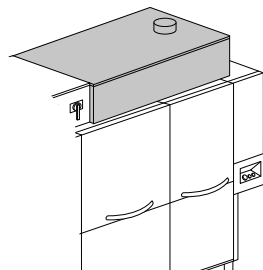

**KHRF20**

heat recovery

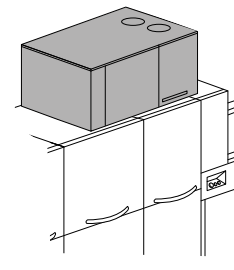

**KHRPF40**

Heat recovery with heat pump

**KDRF9VMB** + 900 mm

Steam heated dryer module

**KSCF10**

Steam condenser

## OPTIONS

	MI900	MI1200	MIS1200	MI1500	MI1800	MI2200	MIR2200
Model	Entry mod. 900	Entry mod. 1200	Over. entry mod. 1200	Entry mod. 1500	Entry mod. 1800	Entry mod. 2200	Lowered belt entry mod. 2200
<b>QK 2460 - QK 2460 AS6</b>	€	€	●	€	€	€	€
<b>QK 2460 V - QK 2460 AS6 V</b>	€	€	●	€	€	€	€
<b>QK 3760 - QK 3760 AS6</b>	€	€	●	€	€	€	€
<b>QK 3760 V - QK 3760 AS6 V</b>	€	€	●	€	€	€	€
<b>QK 4160 - QK 4160 AS6</b>	€	€	●	€	€	€	€
<b>QK 4160 V - QK 4160 AS6 V</b>	€	€	●	€	€	€	€
<b>QK 5360 - QK 5360 AS6</b>	€	€	●	€	€	€	€
<b>QK 5360 V - QK 5360 AS6 V</b>	€	€	●	€	€	€	€
<b>QK 5960 - QK 5960 AS6</b>	€	€	●	€	€	€	€
<b>QK 5960 V - QK 5960 AS6 V</b>	€	€	●	€	€	€	€
<b>QK 6760 - QK 6760 AS6</b>	€	€	●	€	€	€	€
<b>QK 6760 V - QK 6760 AS6 V</b>	€	€	●	€	€	€	€
<b>QK 7760 - QK 7760 AS6</b>	€	€	●	€	€	€	€
<b>QK 7760 V - QK 7760 AS6 V</b>	€	€	●	€	€	€	€

- Standard
- Upon request
- Not available

Option compatibility to be confirmed by the manufacturer after verification

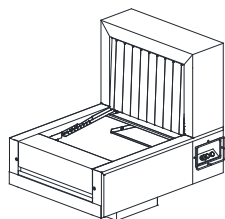

Overhanging entry module

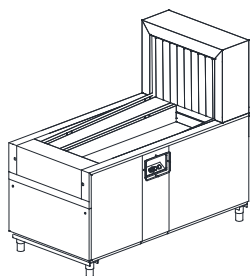

Entry module

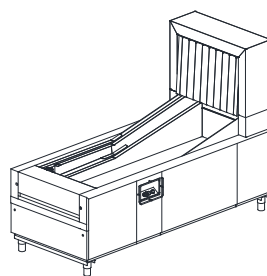

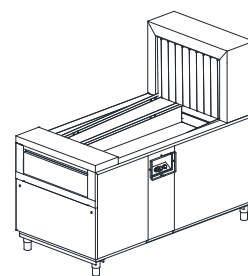

Lowered belt entry module

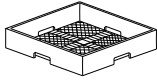
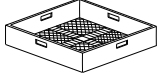
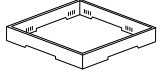
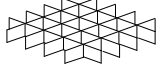
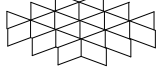

Exit module

	MI2700	MIR2700	EM900	EM1200	EM1500	EM1800	EM2200	EM2700
Model	Entry mod. 2700	Lowered belt entry mod. 2700	Exit mod. 900	Exit mod. 1200	Exit mod. 1500	Exit mod. 1800	Exit mod. 2200	Exit mod. 2700
<b>QK 2460 - QK 2460 AS6</b>	€	€	□	□	□	●	€	€
<b>QK 2460 V - QK 2460 AS6 V</b>	€	€	□	□	□	●	€	€
<b>QK 3760 - QK 3760 AS6</b>	€	€	□	□	□	●	€	€
<b>QK 3760 V - QK 3760 AS6 V</b>	€	€	□	□	□	●	€	€
<b>QK 4160 - QK 4160 AS6</b>	€	€	□	□	□	●	€	€
<b>QK 4160 V - QK 4160 AS6 V</b>	€	€	□	□	□	●	€	€
<b>QK 5360 - QK 5360 AS6</b>	€	€	□	□	□	●	€	€
<b>QK 5360 V - QK 5360 AS6 V</b>	€	€	□	□	□	●	€	€
<b>QK 5960 - QK 5960 AS6</b>	€	€	□	□	□	●	€	€
<b>QK 5960 V - QK 5960 AS6 V</b>	€	€	□	□	□	●	€	€
<b>QK 6760 - QK 6760 AS6</b>	€	€	□	□	□	□	●	€
<b>QK 6760 V - QK 6760 AS6 V</b>	€	€	□	□	□	□	●	€
<b>QK 7760 - QK 7760 AS6</b>	€	€	□	□	□	□	●	€
<b>QK 7760 V - QK 7760 AS6 V</b>	€	€	□	□	□	□	●	€

	Description	Capacity	Dimensions	Code	
	NARROW MESH CUTLERY BASKET		500x500x106 H	<b>C 41</b>	
	LARGE MESH BASKET	For glasses	500x500x105 H	<b>C 44</b>	
	HOLDER FOR GLASS SUPPORT	For glass support (C112-C113-C114)	500x500x50 H	<b>C 111</b>	
	GLASS SUPPORT	5x5 Glass Ø 87 mm (C111)	500x500x50 H	<b>C 112</b>	
	GLASS SUPPORT	4x4 Glass Ø 110 mm (C111)	500x500x50 H	<b>C 113</b>	
	GLASS SUPPORT	6x6 Glass Ø 72 mm (C111)	500x500x50 H	<b>C 114</b>	
	CUTLERY BASKET		490x180x140 H	<b>C 47</b>	





You deserve the best. With the new QK PREMIUM "Green", you will have it!

This range has been enhanced and rewarded with the SMART LABEL HOST 2023 award for its functional efficiency. Thanks to innovative pre-rinse and rinse arms, we have achieved exceptional results while maintaining the same performance: 35% water savings compared to previous versions! Added to this innovation is the introduction of new options, including a renewed triple rinse with osmotic water and an improved drying system, which make them flexible, complete and first-class flight-type conveyor dishwashers. Let us not forget that KROMO's vision is to minimize

the use of environmental resources but also your operating costs. Features such as the detergent economizer, the concept of thermal insulation, the CPF system and the double reinforced rinse show KROMO's wish to progress in the search for innovative solutions, ever more profitable and environmental friendly. Unique systems like HDRF make the machine energy self-sufficient and cost effective. Finally, the communication experience with the machine has been revolutionized thanks to the brand new Connectivity remote interaction system, available on all electronic devices and on the brand new KROMO App. Everything is under control in the blink of an eye!



## FEATURES

### STANDARD

- SMART DRIVE+ 10 speed advancement system
- 710 mm wide conveyor
- Plates belt
- TFT 5.7" display and soft touch keyboard
- Frequently used keys shortcut and menu language setting
- Constant monitoring of key operations
- IPX5 electronic board
- Alarms and events report
- Autotimer
- Break Tank system
- Centralized 1-DRAIN and automatic AD drain, with total or partial emptying of the tanks
- Wash arms ALL-IN-1
- Use economizer
- ECO-DET Detergent economizer
- Thermal and acoustic insulation of both the machine and tanks
- ACID PROOF Radial wash tanks in S/S AISI 316 inclined to provide complete drainage of the wash water
- S/S surface filters CLEAN+ to protect the wash tanks as well as the wash pump
- Double-skin, insulated and counterbalanced doors, equipped with anti-drop safety system
- THERMO BARRIER system for comfort in use
- Predisposition for KROMO rinse-aid and detergent dispensers connection
- ACID PROOF stainless steel boilers in AISI 316, fully insulated to reduce thermal loss.
- Vertical self-cleaning pumps
- Booster pump
- 🌿 Reinforced triple rinse 3R+ : improved consumptions (reverse osmosis on request)
- CPF System: Controlled Pressure Flow
- Water, energy consumptions and working time control system
- Possible working modes for dryer unit: all off, only fan, half power 4,5 kW + fan, total power 9 kW + fan



## FEATURES

### OPTIONS

- Five different conveyor belts available, also with cutlery lane
- Different types of dryers: double skin dryer on module (with or without turboblowers) or on shelf
- **NEW:** double skin lateral dryer on shelf: innovative system with upper fan for improved drying results
- Two types of steam condensers available
- Three models of heat recovery to be chosen
- HDRF: patented insulated linear system of dryer and heat recovery Steam-heated system available. Self-cleaning of the heat exchanger included"
- **NEW:** triple reinforced rinse 3R+ con reverse osmotic water on a separate module
- AS6 Automatic shower with EASY+ with filter system
- Dispensers kit with peristaltic pump, for detergent as well as rinse-aid
- CONNECTIVITY remote control compliant with the HACCP norms (on request)
- Delivery in two or more parts, to ease installation operations
- Automatic self-cleaning of the machine available, with dedicated booster pump on request
- STOCK: Dedicated space for detergent and rinse-aid jugs
- S/S pumps
- Extra power in the boiler

## STANDARD BELTS

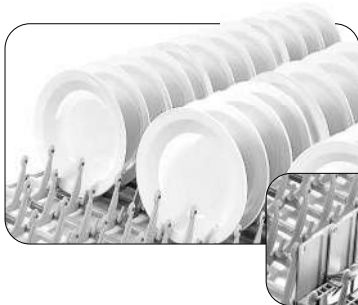

Standard belt for plates and optional cutlery lane



Standard belt for glasses



Standard belt for trays and utensils

## OPTIONAL BELTS



Special belt for hospitals



Special belt for thermal trays



Special belt for in-flight catering



## CONNECTIVITY 4.0 & APP

WHEREVER YOU ARE...  
YOUR DISHWASHER, JUST A CLICK AWAY

You will be constantly connected to the machine to monitor the work phases, review any eventual alarm and configure remotely the operating parameters according to your needs. Compliant with HACCP norms. Thanks to our brand new App, you will have access to connected machines and all commercial and technical documentation.

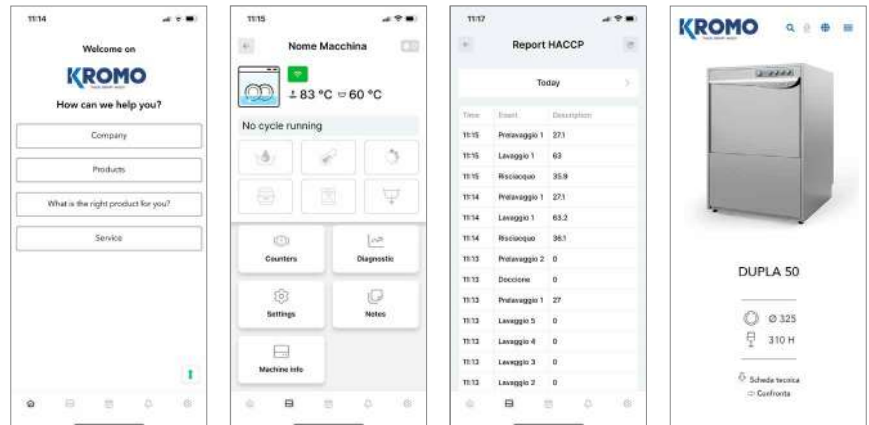

## SMART LABEL HOST 2023 FOR FUNCTIONAL EFFICIENCY

According to the KROMO's sustainability vision and attention to customer operating costs, the QK range of flight conveyor dishwashers has been renewed. The result is a great reduction in water consumption: more than 35% when compared to the previous version, an important figure in today's environmental and economic needs. To do so, new rinse and pre-rinse arms and ramps have been designed to achieve one of the lowest consumption levels in our sector. With lower water, KROMO continues to ensure high quality rinsing results. Indeed, a higher washing pressure guarantees optimal results with the removal of all the chemicals present on the dishes. Such reduction of water also means significant savings in terms of detergent and energy, that have become very high expenditure items.



View all the working parameters and historical events, working hours and any problems at any time.











In case of problems, the machine promptly sends an email to you and to the technician who can intervene remotely to solve the problem or equip himself for on-site intervention.

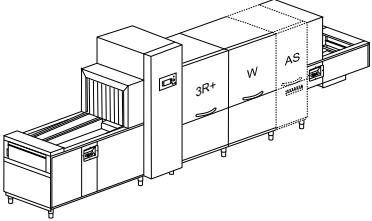

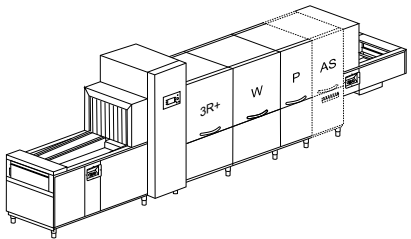

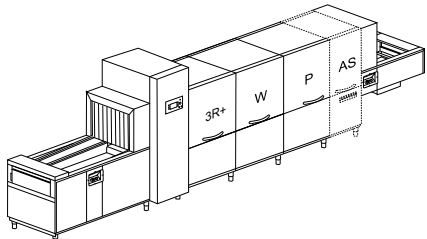

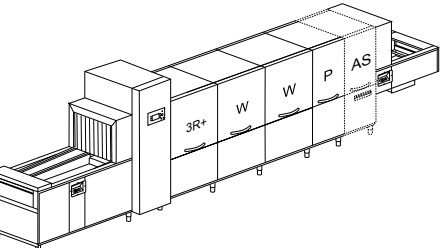

The program allows you to remove an Excel file with all Haccp data at any time.

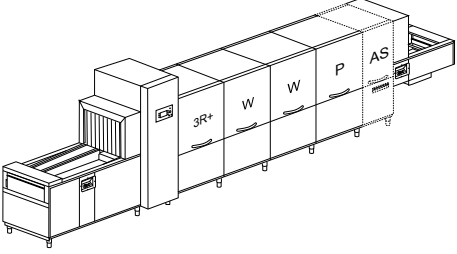

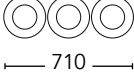
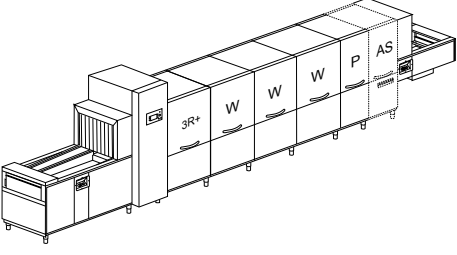
Discounts are provided for the purchase of 4.0 devices. You will be able to recover 40% of the cost of the car. Request more information to find out more.

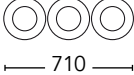
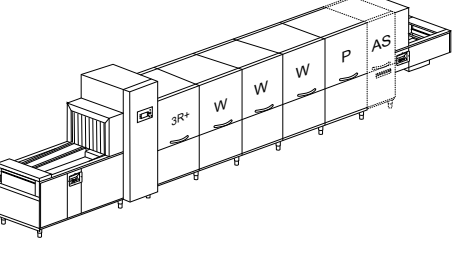
Model	Voltage	Capacity	Dimensions	Code
<b>QK 2500</b> 10 SPEEDS				
<i>IMPROVED</i>				
	400 V 3N ~ 50 Hz 27,75 kW	 450 H		<b>QK 2500</b>
		 710	5500x1110 2070/2200H 715 kg	<b>QK 2500 AS6</b>
	400 V 3N ~ 50 Hz 3,25 kW 17 kg/h	1950 / 3690 dishes / h	AS6 +600 mm	<b>QK 2500 V</b>
		2850* dishes / h		<b>QK 2500 V AS6</b>
<b>QK 3800</b> 10 SPEEDS				
<i>IMPROVED</i>				
	400 V 3N ~ 50 Hz 30,2 kW	 450 H		<b>QK 3800</b>
		 710	6100x1110 2070/2200H 850 kg	<b>QK 3800 AS6</b>
	400 V 3N ~ 50 Hz 4,2 kW 20 kg/h	2400 / 4050 dishes / h	AS6 +600 mm	<b>QK 3800 V</b>
		3660* dishes / h		<b>QK 3800 V AS6</b>
<b>QK 4200</b> 10 SPEEDS				
<i>IMPROVED</i>				
	400 V 3N ~ 50 Hz 34,25 kW	 450 H		<b>QK 4200</b>
		 710	6400x1110 2070/2200H 865 kg	<b>QK 4200 AS6</b>
	400 V 3N ~ 50 Hz 5,25 kW 25 kg/h	3000 / 4800 dishes / h	AS6 +600 mm	<b>QK 4200 V</b>
		4200* dishes / h		<b>QK 4200 V AS6</b>
<b>QK 5400</b> 10 SPEEDS				
<i>IMPROVED</i>				
	400 V 3N ~ 50 Hz 50,2 kW	 450 H		<b>QK 5400</b>
		 710	7000x1110 2070/2200H 1000 kg	<b>QK 5400 AS6</b>
	400 V 3N ~ 50 Hz 6,2 kW 29 kg/h	4200 / 6450 dishes / h	AS6 +600 mm	<b>QK 5400 V</b>
		5100* dishes / h		<b>QK 5400 V AS6</b>

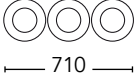
Model	Voltage	Capacity	Dimensions	Code
<b>QK 6000</b> 10 SPEEDS				
<i>IMPROVED</i>				
	400 V 3N ~ 50 Hz 51,25 kW	 450 H   710	7300x1110x2070/2200H 1015 kg  AS6 +600 mm	<b>QK 6000</b>
	400 V 3N ~ 50 Hz 7,25 kW 29 kg/h	4350 / 6750 dishes / h  5550* dishes / h		<b>QK 6000 AS6</b>  <b>QK 6000 V</b>  <b>QK 6000 V AS6</b>
<b>QK 6800</b> 10 SPEEDS				
<i>IMPROVED</i>				
	400 V 3N ~ 50 Hz 70,2 kW	 450 H   710	8300x1110x2070/2200H 1150 kg  AS6 +600 mm	<b>QK 6800</b>
	400 V 3N ~ 50 Hz 8,2 39 kg/h	5250 / 8100 dishes / h  5550* dishes / h		<b>QK 6800 AS6</b>  <b>QK 6800 V</b>  <b>QK 6800 V AS6</b>
<b>QK 7800</b> 10 SPEEDS				
<i>IMPROVED</i>				
	400 V 3N ~ 50 Hz 74,25 kW	 450 H   710	8600x1110x2070/2200H 1165 kg  AS6 +600 mm	<b>QK 7800</b>
	400 V 3N ~ 50 Hz 9,25 kW 44 kg/h	5850 / 9000 dishes / h  6900* dishes / h		<b>QK 7800 AS6</b>  <b>QK 7800 V</b>  <b>QK 7800 V AS6</b>

- P** Prewash
- W** Wash
- 3R+** Reinforced triple rinse with low water consumption: double pre-rinse + rinse on module
- AS6** Automatic shower with filter drawer +600 mm
- V** Steam-heated
- \*** Productivity according to DIN SPEC 10534 regulation ( contact time )

EAC label upon request

Option compatibility to be confirmed by the manufacturer after verification

## OPTIONS

				AUTOTIMER	PRE DOS	DDE-GROUP	DOS/S	SAN
Model	220-240 V 3 50 Hz	380-415 V 3N 50 Hz	60 Hz	Autotimer	Kromo disp. connections	Dispensers kit	Dispenser with probe	Sanitization System
<b>QK 2500</b>	+ 2%	●	+ 3%	●	●	€	€	€
<b>QK 2500 AS6</b>	+ 2%	●	+ 3%	●	●	€	€	€
<b>QK 2500 V</b>	+ 1%	●	+ 3%	●	●	€	€	€
<b>QK 2500 V AS6</b>	+ 1%	●	+ 3%	●	●	€	€	€
<b>QK 3800</b>	+ 2%	●	+ 3%	●	●	€	€	€
<b>QK 3800 AS6</b>	+ 2%	●	+ 3%	●	●	€	€	€
<b>QK 3800 V</b>	+ 1%	●	+ 3%	●	●	€	€	€
<b>QK 3800 V AS6</b>	+ 1%	●	+ 3%	●	●	€	€	€
<b>QK 4200</b>	+ 2%	●	+ 3%	●	●	€	€	€
<b>QK 4200 AS6</b>	+ 2%	●	+ 3%	●	●	€	€	€
<b>QK 4200 V</b>	+ 1%	●	+ 3%	●	●	€	€	€
<b>QK 4200 V AS6</b>	+ 1%	●	+ 3%	●	●	€	€	€
<b>QK 5400</b>	+ 2%	●	+ 3%	●	●	€	€	€
<b>QK 5400 AS6</b>	+ 2%	●	+ 3%	●	●	€	€	€
<b>QK 5400 V</b>	+ 1%	●	+ 3%	●	●	€	€	€
<b>QK 5400 V AS6</b>	+ 1%	●	+ 3%	●	●	€	€	€
<b>QK 6000</b>	+ 2%	●	+ 3%	●	●	€	€	€
<b>QK 6000 AS6</b>	+ 2%	●	+ 3%	●	●	€	€	€
<b>QK 6000 V</b>	+ 1%	●	+ 3%	●	●	€	€	€
<b>QK 6000 V AS6</b>	+ 1%	●	+ 3%	●	●	€	€	€
<b>QK 6800</b>	+ 2%	●	+ 3%	●	●	€	€	€
<b>QK 6800 AS6</b>	+ 2%	●	+ 3%	●	●	€	€	€
<b>QK 6800 V</b>	+ 1%	●	+ 3%	●	●	€	€	€
<b>QK 6800 V AS6</b>	+ 1%	●	+ 3%	●	●	€	€	€
<b>QK 7800</b>	+ 2%	●	+ 3%	●	●	€	€	€
<b>QK 7800 AS6</b>	+ 2%	●	+ 3%	●	●	€	€	€
<b>QK 7800 V</b>	+ 1%	●	+ 3%	●	●	€	€	€
<b>QK 7800 V AS6</b>	+ 1%	●	+ 3%	●	●	€	€	€

● Standard

□ Upon request

**DDE-GROUP** Both detergent (with probe) and rinse-aid dispensers included

**DWI** Insulation option for the tunnel only, dryer excluded. Shelf dryer can be double skin upon request

Peak-cut connect upon request

Water supply 55 °C

We recommend to install the machine in a well ventilated room, with a properly sized steam exhausting system

	PAP-SAN	DWI	DWI / T	CONNECTIVITY	XP	PAP	SMART DRIVE+
Model	Booster Pump Sanitiz.	Thermoacoustic insulation	Tank insulation	Connectivity (HACCP)	Extra Power	Booster pump	Smart drive 10 speeds
<b>QK 2500</b>	€	€	●	€	€	●	●
<b>QK 2500 AS6</b>	€	€	●	€	€	●	●
<b>QK 2500 V</b>	€	€	●	€	□	●	●
<b>QK 2500 V AS6</b>	€	€	●	€	□	●	●
<b>QK 3800</b>	€	€	●	€	€	●	●
<b>QK 3800 AS6</b>	€	●	●	€	€	●	●
<b>QK 3800 V</b>	€	€	●	€	□	●	●
<b>QK 3800 V AS6</b>	€	●	●	€	□	●	●
<b>QK 4200</b>	€	€	●	€	€	●	●
<b>QK 4200 AS6</b>	€	●	●	€	€	●	●
<b>QK 4200 V</b>	€	€	●	€	□	●	●
<b>QK 4200 V AS6</b>	€	●	●	€	□	●	●
<b>QK 5400</b>	€	●	●	€	€	●	●
<b>QK 5400 AS6</b>	€	●	●	€	€	●	●
<b>QK 5400 V</b>	€	●	●	€	€	●	●
<b>QK 5400 V AS6</b>	€	●	●	€	€	●	●
<b>QK 6000</b>	€	●	●	€	€	●	●
<b>QK 6000 AS6</b>	€	●	●	€	€	●	●
<b>QK 6000 V</b>	€	●	●	€	€	●	●
<b>QK 6000 V AS6</b>	€	●	●	€	€	●	●
<b>QK 6800</b>	€	●	●	€	€	●	●
<b>QK 6800 AS6</b>	€	●	●	€	€	●	●
<b>QK 6800 V</b>	€	●	●	€	€	●	●
<b>QK 6800 V AS6</b>	€	●	●	€	€	●	●
<b>QK 7800</b>	€	●	●	€	€	●	●
<b>QK 7800 AS6</b>	€	●	●	€	€	●	●
<b>QK 7800 V</b>	€	●	●	€	□	●	●
<b>QK 7800 V AS6</b>	€	●	●	€	□	●	●

**CONNECTIVITY** Includes HACCP option. 10 year plan

**XP** In case of cold water supply for rinse 8 °C 55 °C, and without any heat recovery, the extra power option is mandatory  
In case of cold water supply for rinse (8-15 °C), we recommend to install the heat recovery system optional.

Option compatibility to be confirmed by the manufacturer after verification

## OPTIONS

Model	Master switch	Surface filters	Peak-cut for Kromo dosing	Estimated consumption readout	PI	1-DRAIN
QK 2500	●	●	●	●	€	●
QK 2500 AS6	●	●	●	●	€	●
QK 2500 V	●	●	●	●	€	●
QK 2500 V AS6	●	●	●	●	€	●
QK 3800	●	●	●	●	€	●
QK 3800 AS6	●	●	●	●	€	●
QK 3800 V	●	●	●	●	€	●
QK 3800 V AS6	●	●	●	●	€	●
QK 4200	●	●	●	●	€	●
QK 4200 AS6	●	●	●	●	€	●
QK 4200 V	●	●	●	●	€	●
QK 4200 V AS6	●	●	●	●	€	●
QK 5400	●	●	●	●	€	●
QK 5400 AS6	●	●	●	●	€	●
QK 5400 V	●	●	●	●	€	●
QK 5400 V AS6	●	●	●	●	€	●
QK 6000	●	●	●	●	€	●
QK 6000 AS6	●	●	●	●	€	●
QK 6000 V	●	●	●	●	€	●
QK 6000 V AS6	●	●	●	●	€	●
QK 6800	●	●	●	●	€	●
QK 6800 AS6	●	●	●	●	€	●
QK 6800 V	●	●	●	●	€	●
QK 6800 V AS6	●	●	●	●	€	●
QK 7800	●	●	●	●	€	●
QK 7800 AS6	●	●	●	●	€	●
QK 7800 V	●	●	●	●	€	●
QK 7800 V AS6	●	●	●	●	€	●

● Standard

--- Not available

**LANE** Only with KDRF69 - KDRF6V

**DIV** Compulsory for machines > 4,5 m

**BT** Booster pump included

**DVGW** Not available with heat recovery and steam condenser  
Components prescribed by DVGW on request (check option compatibility with the manufacturer)

	AD	ECO-DET	X-BELT	LANE	DIV	BT	DVGW
Model	Automatic drain	Detergent economizer	Special belt	Cutlery lane	Price for division	Break tank	DVGW
<b>QK 2500</b>	●	●	+ 7 %	----	€	●	€
<b>QK 2500 AS6</b>	●	●	+ 7 %	----	€	●	€
<b>QK 2500 V</b>	●	●	+ 7 %	----	€	●	€
<b>QK 2500 V AS6</b>	●	●	+ 7 %	----	€	●	€
<b>QK 3800</b>	●	●	+ 7 %	----	€	●	€
<b>QK 3800 AS6</b>	●	●	+ 7 %	----	€	●	€
<b>QK 3800 V</b>	●	●	+ 7 %	----	€	●	€
<b>QK 3800 V AS6</b>	●	●	+ 7 %	----	€	●	€
<b>QK 4200</b>	●	●	+ 7 %	+ 5 %	€	●	€
<b>QK 4200 AS6</b>	●	●	+ 7 %	----	€	●	€
<b>QK 4200 V</b>	●	●	+ 7 %	+ 5 %	€	●	€
<b>QK 4200 V AS6</b>	●	●	+ 7 %	----	€	●	€
<b>QK 5400</b>	●	●	+ 7 %	----	€	●	€
<b>QK 5400 AS6</b>	●	●	+ 7 %	----	€	●	€
<b>QK 5400 V</b>	●	●	+ 7 %	----	€	●	€
<b>QK 5400 V AS6</b>	●	●	+ 7 %	----	€	●	€
<b>QK 6000</b>	●	●	+ 7 %	+ 5 %	€	●	€
<b>QK 6000 AS6</b>	●	●	+ 7 %	----	€	●	€
<b>QK 6000 V</b>	●	●	+ 7 %	+ 5 %	€	●	€
<b>QK 6000 V AS6</b>	●	●	+ 7 %	----	€	●	€
<b>QK 6800</b>	●	●	+ 7 %	----	€	●	€
<b>QK 6800 AS6</b>	●	●	+ 7 %	----	€	●	€
<b>QK 6800 V</b>	●	●	+ 7 %	----	€	●	€
<b>QK 6800 V AS6</b>	●	●	+ 7 %	----	€	●	€
<b>QK 7800</b>	●	●	+ 7 %	+ 5 %	€	●	€
<b>QK 7800 AS6</b>	●	●	+ 7 %	----	€	●	€
<b>QK 7800 V</b>	●	●	+ 7 %	+ 5 %	€	●	€
<b>QK 7800 V AS6</b>	●	●	+ 7 %	----	€	●	€

Option compatibility to be confirmed by the manufacturer after verification

## OPTIONS

Model	NZ3 Neutral zone 300	NZ6 Neutral zone 600	NZH6 Neutral zone for dryer 600	KDRF68 Shelf dryer	KDRF69 Shelf dryer	KDRF6V Steam- heated shelf dryer	KDRF70 Shelf dryer	KDRF7V Steam- heated shelf dryer	KDRF99M Stage Dryer	KDRF9VM Steam heated stage dryer	KDRF99MB Stage dryer with blowers	KDRF9VMB Steam heated stage dryer with blowers
<b>QK 2500 - QK 2500 AS6</b>	€	€	€	€	€	----	€	----	€	----	€	----
<b>QK 2500 V - QK 2500 V AS6</b>	€	€	€	€	€	€	€	€	€	€	€	€
<b>QK 3800 - QK 3800 AS6</b>	€	€	€	€	€	----	€	----	€	----	€	----
<b>QK 3800 V - QK 3800 V AS6</b>	€	€	€	€	€	€	€	€	€	€	€	€
<b>QK 4200 - QK 4200 AS6</b>	€	€	€	€	€	----	€	----	€	----	€	----
<b>QK 4200 V - QK 4200 V AS6</b>	€	€	€	€	€	€	€	€	€	€	€	€
<b>QK 5400 - QK 5400 AS6</b>	€	€	€	€	€	----	€	----	€	----	€	----
<b>QK 5400 V - QK 5400 V AS6</b>	€	€	€	€	€	€	€	€	€	€	€	€
<b>QK 6000 - QK 6000 AS6</b>	€	€	€	€	€	----	€	----	€	----	€	----
<b>QK 6000 V - QK 6000 V AS6</b>	€	€	€	€	€	€	€	€	€	€	€	€
<b>QK 6800 - QK 6800 AS6</b>	€	€	€	€	€	----	€	----	€	----	€	----
<b>QK 6800 V - QK 6800 V AS6</b>	€	€	€	€	€	€	€	€	€	€	€	€
<b>QK 7800 - QK 7800 AS6</b>	€	€	€	€	€	----	€	----	€	----	€	----
<b>QK 7800 V - QK 7800 V AS6</b>	€	€	€	€	€	€	€	€	€	€	€	€

---- Not available

**NZ3** Recommended with big quantities of trays to wash

**NZ6** Recommended for big quantities of trays to wash. Module equipped with a front door

**NZH6** Recommended with dryers with blowers

**KDRF99M - KDRF9VM - KDRF99MB** Module with front door

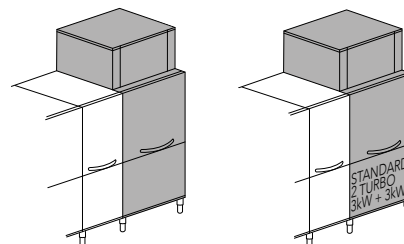
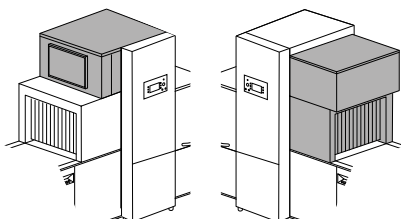
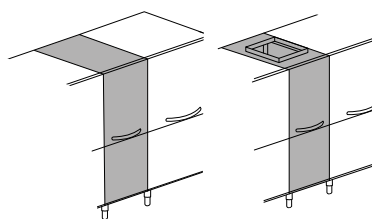

**NZ3** + 300 mm  
Neutral zone

**NZH6** + 600 mm  
Neutral zone with  
door for dryer

**NZ6** + 600 mm  
Neutral zone with  
door

**KDRF68** 9 kW  
Shelf drying compact

**KDRF69** 9 kW  
Shelf dryer

**KDRF6V**  
Steam-heated shelf dryer

**KDRF70**  
Double skin lateral shelf dryer with  
upper fan

**KDRF7V**  
Steam-heated double skin shelf  
lateral dryer with upper fan

**KDRF99M**  
+ 900 mm - 9 kW  
Dryer module

**KDRF9VM** + 900 mm  
Steam-heated dryer  
module

**KDRF99MB**  
+ 900 mm - 15 kW  
Dryer module

**KDRF9VMB** + 900 mm  
Steam-heated dryer  
module



Model	KSCF10 Steam condenser	KSCF15 Steam condenser	KHRF15 heat recovery	KHRF20 heat recovery	KHRPF40 heat recovery	3R+ Triple reinforced rinse	3R+ RO Triple reinforced rinse with RO	STOCK Chemicals compartment	KHDRF Heat recovery with dryer	KHDRFV Heat recovery with dryer
<b>QK 2500 - QK 2500 AS6</b>	€	€	€	€	€	●	€	€	€	----
<b>QK 2500 V - QK 2500 V AS6</b>	€	€	€	€	€	●	€	€	----	€
<b>QK 3800 - QK 3800 AS6</b>	€	€	€	€	€	●	€	€	€	----
<b>QK 3800 V - QK 3800 V AS6</b>	€	€	€	€	€	●	€	€	----	€
<b>QK 4200 - QK 4200 AS6</b>	€	€	€	€	€	●	€	€	€	----
<b>QK 4200 V - QK 4200 V AS6</b>	€	€	€	€	€	●	€	€	----	€
<b>QK 5400 - QK 5400 AS6</b>	€	€	€	€	€	●	€	€	€	----
<b>QK 5400 V - QK 5400 V AS6</b>	€	€	€	€	€	●	€	€	----	€
<b>QK 6000 - QK 6000 AS6</b>	€	€	€	€	€	●	€	€	€	----
<b>QK 6000 V - QK 6000 V AS6</b>	€	€	€	€	€	●	€	€	----	€
<b>QK 6800 - QK 6800 AS6</b>	€	€	€	€	€	●	€	€	€	----
<b>QK 6800 V - QK 6800 V AS6</b>	€	€	€	€	€	●	€	€	----	€
<b>QK 7800 - QK 7800 AS6</b>	€	€	€	€	€	●	€	€	€	----
<b>QK 7800 V - QK 7800 V AS6</b>	€	€	€	€	€	●	€	€	----	€

**KSCF15** Not available with optional dryer

**3R+** Reinforced triple rinse: Improved consumptions (with reverse osmosis water on request).

**KHRF15 - KHRF20 - KHRPF40 - KHDRF - KHDRFV** In case of cold water supply for rinse (8-15 °C), we recommend to install the heat recovery system optional.

With osmotic water supply and electrical conductivity lower than 200 microsiemens, it is mandatory to install a stainless steel heat exchanger

All dryers are double skin

Option compatibility to be confirmed by the manufacturer after verification

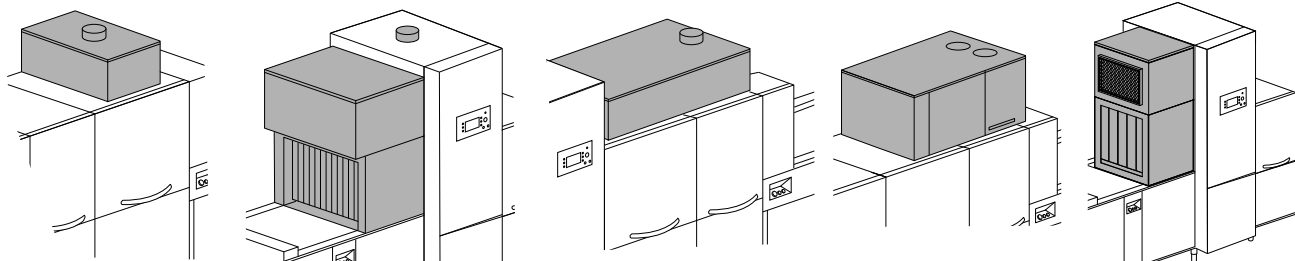

**KSCF10**  
Steam condenser

**KHRF15**  
Reinforced compact heat recovery

**KHRF20**  
heat recovery

**KHRPF40**  
Heat recovery with heat pump

**KHDRF**  
Electric dryer 9 kW + heat recovery

**KSCF15**  
Reinforced steam condenser

**KHDRFV**  
Steam heated dryer + heat recovery

## OPTIONS

	MI900	MI1200	MIS1200	MI1500	MI1800	MI2200	MIR2200
Model	Entry mod. 900	Entry mod. 1200	Over. entry mod. 1200	Entry mod. 1500	Entry mod. 1800	Entry mod. 2200	Lowered belt entry mod. 2200
<b>QK 2500 - QK 2500 AS6</b>	€	€	●	€	€	€	€
<b>QK 2500 V - QK 2500 V AS6</b>	€	€	●	€	€	€	€
<b>QK 3800 - QK 3800 AS6</b>	€	€	●	€	€	€	€
<b>QK 3800 V - QK 3800 V AS6</b>	€	€	●	€	€	€	€
<b>QK 4200 - QK 4200 AS6</b>	€	€	●	€	€	€	€
<b>QK 4200 V - QK 4200 V AS6</b>	€	€	●	€	€	€	€
<b>QK 5400 - QK 5400 AS6</b>	€	€	●	€	€	€	€
<b>QK 5400 V - QK 5400 V AS6</b>	€	€	●	€	€	€	€
<b>QK 6000 - QK 6000 AS6</b>	€	€	●	€	€	€	€
<b>QK 6000 V - QK 6000 V AS6</b>	€	€	●	€	€	€	€
<b>QK 6800 - QK 6800 AS6</b>	€	€	●	€	€	€	€
<b>QK 6800 V - QK 6800 V AS6</b>	€	€	●	€	€	€	€
<b>QK 7800 - QK 7800 AS6</b>	€	€	●	€	€	€	€
<b>QK 7800 V - QK 7800 V AS6</b>	€	€	●	€	€	€	€

- Standard
- Upon request
- Not available

Option compatibility to be confirmed by the manufacturer after verification

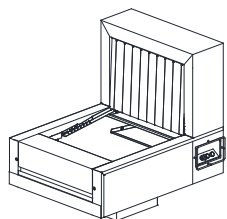

Overhanging entry module

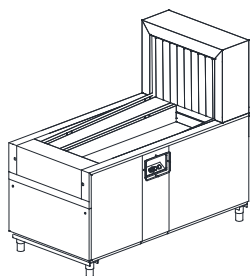

Entry module

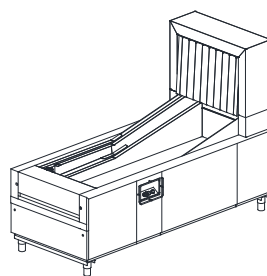

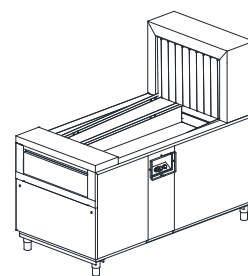

Lowered belt entry module

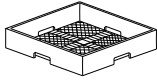
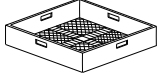
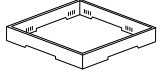
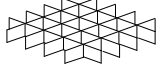
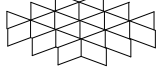

Exit module

	MI2700	MIR2700	EM900	EM1200	EM1500	EM1800	EM2200	EM2700
Model	Entry mod. 2700	Lowered belt entry mod. 2700	Exit mod. 900	Exit mod. 1200	Exit mod. 1500	Exit mod. 1800	Exit mod. 2200	Exit mod. 2700
<b>QK 2500 - QK 2500 AS6</b>	€	€	□	□	□	●	€	€
<b>QK 2500 V - QK 2500 V AS6</b>	€	€	□	□	□	●	€	€
<b>QK 3800 - QK 3800 AS6</b>	€	€	□	□	□	●	€	€
<b>QK 3800 V - QK 3800 V AS6</b>	€	€	□	□	□	●	€	€
<b>QK 4200 - QK 4200 AS6</b>	€	€	□	□	□	●	€	€
<b>QK 4200 V - QK 4200 V AS6</b>	€	€	□	□	□	●	€	€
<b>QK 5400 - QK 5400 AS6</b>	€	€	□	□	□	●	€	€
<b>QK 5400 V - QK 5400 V AS6</b>	€	€	□	□	□	●	€	€
<b>QK 6000 - QK 6000 AS6</b>	€	€	□	□	□	●	€	€
<b>QK 6000 V - QK 6000 V AS6</b>	€	€	□	□	□	●	€	€
<b>QK 6800 - QK 6800 AS6</b>	€	€	□	□	□	□	●	€
<b>QK 6800 V - QK 6800 V AS6</b>	€	€	□	□	□	□	●	€
<b>QK 7800 - QK 7800 AS6</b>	€	€	□	□	□	□	●	€
<b>QK 7800 V - QK 7800 V AS6</b>	€	€	□	□	□	□	●	€

	Description	Capacity	Dimensions	Code	
	NARROW MESH CUTLERY BASKET		500x500x106 H	<b>C 41</b>	
	LARGE MESH BASKET	For glasses	500x500x105 H	<b>C 44</b>	
	HOLDER FOR GLASS SUPPORT	For glass support (C112-C113-C114)	500x500x50 H	<b>C 111</b>	
	GLASS SUPPORT	5x5 Glass Ø 87 mm (C111)	500x500x50 H	<b>C 112</b>	
	GLASS SUPPORT	4x4 Glass Ø 110 mm (C111)	500x500x50 H	<b>C 113</b>	
	GLASS SUPPORT	6x6 Glass Ø 72 mm (C111)	500x500x50 H	<b>C 114</b>	
	CUTLERY BASKET		490x180x140 H	<b>C 47</b>	





The standard heat recovery uses the steam produced by the machine to preheat the incoming cold water for immediate energy savings.

The special twin-cord conveyor system, sloped and separated by zone, avoids any contamination among modules and supports the special cold

dryer at high pressure. Thanks to its turbo blowers with custom-made air-blades, this technology allows the immediate re-use of the trays



## SELF-CLEANING

The machine's cleaning and sanitization is one of the most dreaded tasks to accomplish at the end of a day at work in the kitchen. For this reason, we have conceived a sanitization system which ensures a thorough and immediate cleaning of all machine's surfaces thanks to the special rinse arms installed on the upper wall, thus offering the perfect solution to meet maximum hygiene requirements. A dedicated sanitization product is combined with a booster pump ensuring the right water pressure: the result will be a spick and span dishwasher!

## FEATURES

- Low voltage electronic control panel
- Fast coupling wash-arms, with concave self cleaning nozzles, equipped with flow adjuster
- ACID PROOF AISI 316 wash tanks, with rounded corners to guarantee a perfect hygiene
- The overflow pipe enables the full draining of the wash tanks without removal
- ACID PROOF AISI 316 stainless steel boilers, fully insulated to reduce thermal losses
- Standard heat recovery
- Double skin insulated doors, counter-balanced, equipped with anti-drop safety system
- THERMO BARRIER system for comfort in use
- CLEAN+ filters
- Built-in turbo blowers feed the air nozzles positioned both above and below the twin-cords
- Turbo-blowers. Thanks to a high pressure of the air vortex
- Trays accumulator in the absence of trolley
- Advancement system. Eases the removal of any solid residual on the tray allowing its complete rinse
- Two speeds traction system with built-in clutch. Speed adjuster on request
- Non-return valve
- Autotimer: built-in device that switches the electrical options
- HACCP: data management software on request

Model	Voltage	Capacity	Dimensions	Code
<b>TK 1600</b>	400 V 3N ~ 50 Hz 44 kW 8,4 - 13,1 m/min Cold water supply	GN 1/1 530x325x35 H	2575x805 2040/2120 H 485 kg	<b>TK 1600</b>

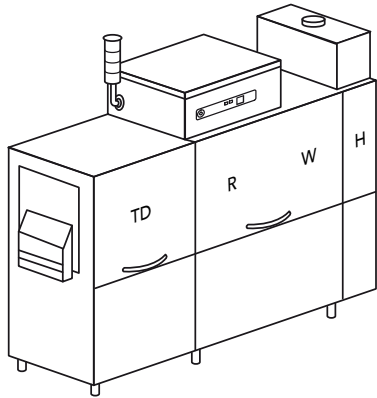

- W** Wash
- R** Single rinse
- TD** Cold dryer with turbo blowers
- H** Heat recovery

## OPTIONS

Model	220-240 V 3 50 Hz	380-415 V 3N 50 Hz	60 Hz	Trays Accumulator	DDE-GROUP Dispensers kit	DOS/S Dispenser with probe	PAP Booster pump	DRIVE Smart drive
<b>TK 1600</b>	€	●	+3%	●	€	€	€	€

- Standard
- DDE-GROUP** Both detergent (with probe) and rinse-aid dispensers included
- DOS/S** Only for detergent dispenser
- DRIVE** Check voltage compatibility

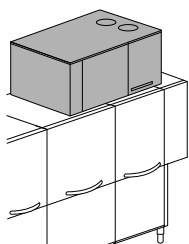

**KHRP40**  
Heat recovery  
with heat pump



Model	Capacity	Dimensions	Code
<b>TL 100</b> TROLLEY FOR TRAYS			

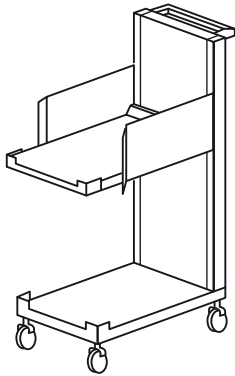

GN 1/1  
530x325x35 H

800x500x900 H  
30 kg

**TL 100**

	DWI	HACCP	PI	AUTOTIMER	KHR5	KHRP40	SAN	PAP-SAN	BT
Model	Thermoacoustic insulation	HACCP supervisor	S/S pumps	Autotimer	heat recovery	Heat recovery with heat pump	Sanitization System	Booster Pump Sanitiz.	Break tank
<b>TK 1600</b>	€	€	€	●	●	€	€	€	€

**KHR5** Heat recovery (cold water supply 8-15°C)

**DWI** Insulation option for the tunnel only, dryer excluded. Shelf dryer can be double skin upon request

**HACCP** Software and cables included

**KHRP40** In alternative to standard compact heat recovery

**BT** Booster pump included

Division not available

Option compatibility to be confirmed by the manufacturer after verification

We recommend to install the machine in a well ventilated room, with a properly sized steam exhausting system

EAC label upon request



Our customized bi-cord transport system is the perfect solution not only to carry, but also to wash and deliver trays. The system limits the workers operations and contains management costs and space while perfectly drying the trays for an immediate use.

With the recent expansion of the range, KROMO now offers tailor-made logistics and waste treatment solutions. Thanks to this comprehensive offer, even the most specific customer needs can be satisfied.

Model

Voltage

Capacity

Code

## CORD CONVEYOR

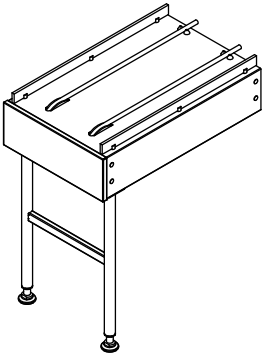

400 V 3N 50 Hz  
--  
230 V 50 Hz  
--  
230 V 3 50 Hz  
Special voltages  
on request

  
530x325x35 H

**BCC**

upon request

## SLAT CONVEYOR FOR TRAYS OR RACKS

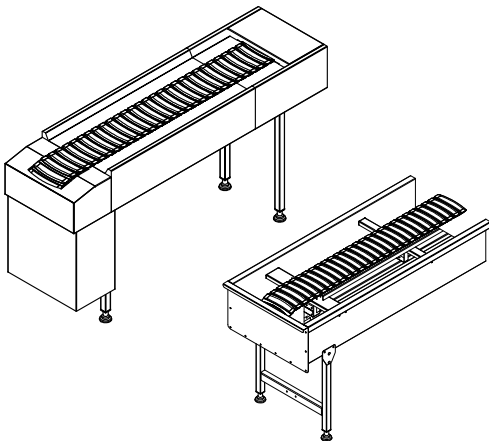

400 V 3N 50 Hz  
--  
230 V 50 Hz  
--  
230 V 3 50 Hz  
Special voltages  
on request

  
530x325x35 H

**SCT**  
trays

upon request

  
500x500

**SCR**  
racks

upon request

## CARDAN CHAIN CONVEYOR

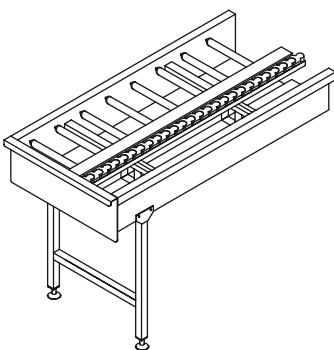

400 V 3N 50 Hz  
--  
230 V 50 Hz  
--  
230 V 3 50 Hz  
Special voltages  
on request

  
500x500

**CCC**

upon request



The technology of the POT line will lead you in an easy and intuitive way, through the functions of your POT washer, directly from the control panel. The TFT color display ( KP 152 EL PLUS / KP 202 EL PLUS / KP 302 EL PLUS / KP 402 EL PLUS ) eases the visualization of the working temperatures and the set wash cycles, both easily modifiable. With the new motorized valve implemented on the KP 202 EL PLUS, KP 302 EL PLUS and KP 402 EL PLUS, together with the possibility of scheduling the start of the cycle, we greatly facilitated the use

and maintenance of these models.

The two-level self-diagnosis system, also present on the KP 152 EL PLUS, allows you to any anomaly very accurately. Besides, the optimized Optimal Rinse rinsing system, the additional Energy Saving function, the high-level performance and high quality of our materials, the competitiveness and versatility of our POT range reach levels that are hard to find on the market.



## FEATURES KP 76 EL - KP 86 EL PLUS

- Four wash cycles (customizable for KP 76 EL)
- Soft Start wash pump (KP 76 EL)
- New intuitive electronic control panel (KP 76 EL)
- High capacity in small dimensions
- Versatility of use
- Double skin
- Deep-formed tank
- Triple pump filter (KP 76 EL)
- Trays (600x400 mm with 90° angle) and EURONORM crates 600x400x400H (with specific griddle 575010)
- Automatic self-cleaning cycle
- PLUS system for a constant rinse (KP 86 EL PLUS)
- Built-in water softener available with automatic regeneration cycle (KP 76 EL)
- CONNECTIVITY remote control compliant with the HACCP norms (on request for KP 76 EL)

## FEATURES KP 136 EL PLUS

- Easy and intuitive LED electronic control panel
- Modification of the dosage of detergent and rinse-aid directly on the on the control panel
- Remote control panel available on request instead of the standard control panel
- Four customizable programs
- Single skin hood
- Double tank filters, with dirt collection system and pump filter (improved system for a better filtration of the wash water)
- Self-cleaning vertical pump
- Soft Start wash pump
- Easy to access for maintenance
- Anti-drop roof panel
- Easily removable basket support
- Self-cleaning cycle
- The PLUS system grants a constant rinse temperature and pressure thanks to the rinse pump
- CONNECTIVITY remote control compliant with the HACCP norms (on request)



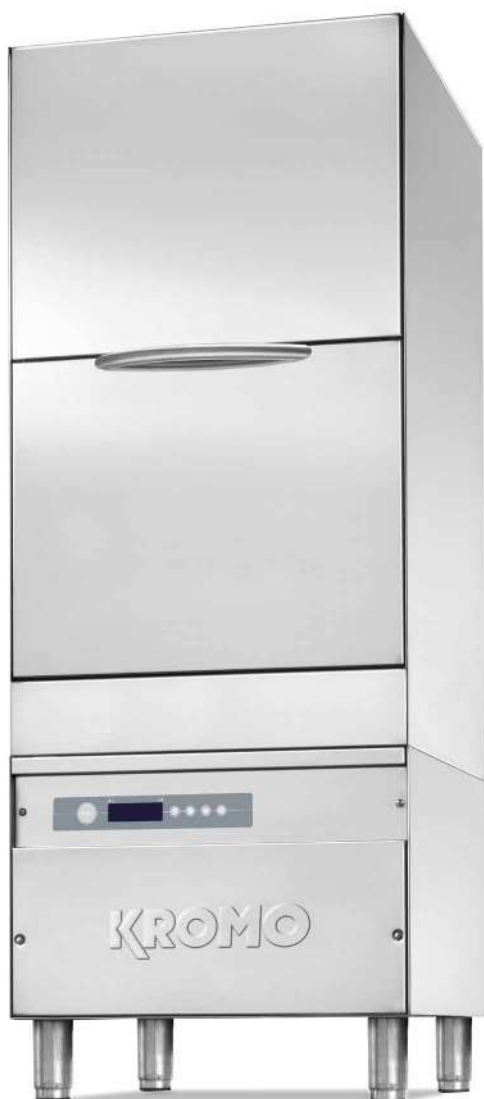

## FEATURES KP 151 EL

- LED control panel with four programmable cycles
- Max loading 805 mm
- Double skin door
- Deep-formed tank
- Double tank filter + pump filter
- Standard rinse pump
- Anti-drop roof panel
- Self-cleaning automatic cycle
- Basket 550x665 mm
- Stainless steel wash and rinse arms

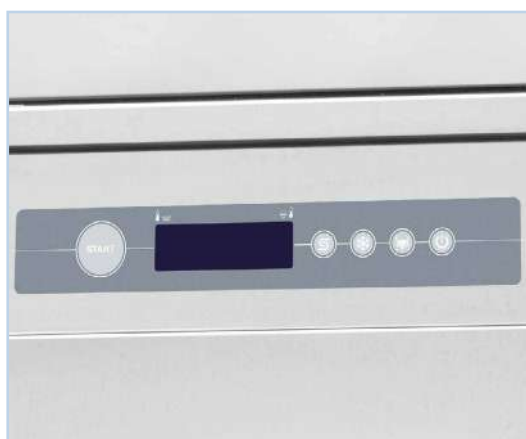

## NEW ELECTRONIC CONTROL PANEL

- LED electronic control panel
- Intuitive START button with multi-color backlight for quick viewing of machine status
- Display of wash and rinse temperatures, cycle progress, selected cycle, machine status (stand-by, end of cycle, etc.) and main warnings description (door opening, drainage, etc.)
- Language selection not available
- 4 programmable cycles (2 - 4 - 6 - 8 minutes)
- Possibility to install the Connectivity-Cloud option

With the warewashing models KP 152 EL HR PLUS / KP 202 EL HR PLUS / KP 302 EL HR PLUS / KP 402 EL HR PLUS, KROMO offers significant energy savings.

The HR system is a heat exchanger: the moist warm water vapour is directly drawn out of the machine when the door is closed, and used for pre-heating the cold water inlet up to around 50 °C. As a result, the energy required to reach the final rinse temperature (approximately 85 °C) is

dramatically reduced. Depending on the model, you can save between 3,5 kWh and 5,5 kWh. KROMO HR technology improves the room air quality and climate as well.

The heat exchanger reduces the exhaust air temperature by more than half.

The entire humidity volume is cut down by approximately 20% of the equivalent machine without any heat recovery unit. This permanently improves the operators' comfort.



## FEATURES KP 152 EL PLUS - KP 202 EL PLUS - KP 302 EL PLUS - KP 402 EL PLUS

- Electronic with energy saving system
- Double skin
- Standard rinse pump
- Self cleaning vertical pump
- Deep-formed chair tank
- Stainless steel independent wash/rinse arms
- Double tank filter with dirt collection system
- Thermostat to grant the rinse temperature according to HACCP regulations
- Multichromatic START key
- Automatic self-cleaning cycle
- Four customizable wash cycles
- The wash pump activate one after the other to reduce the electric peak( KP 202 EL PLUS / KP 302 EL PLUS / KP 402 EL PLUS)
- Double skin door that can be used as a countertop
- Innovative drain valve system ( KP 202 EL PLUS / KP 302 EL PLUS / KP 402 EL PLUS) for automatized drain
- 5" TFT touch display
- Optional heat recovery (HR)
- CONNECTIVITY remote control compliant with the HACCP norms (on request)

## CONNECTIVITY 4.0 & APP

WHEREVER YOU ARE...  
YOUR DISHWASHER, JUST A CLICK AWAY

You will be constantly connected to the machine to monitor the work phases, review any eventual alarm and configure remotely the operating parameters according to your needs. Compliant with HACCP norms. Thanks to our brand new App, you will have access to connected machines and all commercial and technical documentation.

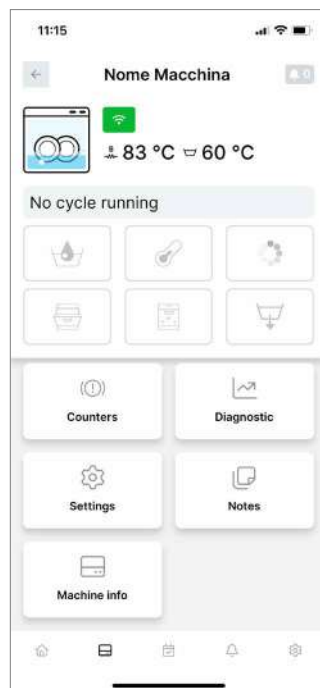

View all the working parameters and historical events, working hours and any problems at any time.



In case of problems, the machine promptly sends an email to you and to the technician who can intervene remotely to solve the problem or equip himself for on-site intervention.



The program allows you to remove an Excel file with all Haccp data at any time.



Our Connectivity system is a revolutionary device limiting and facilitating the eventual intervention of a technician who can anticipate the necessary parts to be replaced, saving time and money.





STEAM RECOVERY



ENERGY SAVINGS



SUSTAINABILITY

## HR:

### HEAT RECOVERY SYSTEM

With the Kromo warewashing models KP 152 EL HR PLUS / KP 202 EL HR PLUS / KP 302 EL HR PLUS / KP 402 EL HR PLUS, KROMO up to 50% of energy costs can be saved!

The HR system is a heat exchanger: the moist warm water vapour is drawn directly out of the machine when the door is closed, and used for pre-heating the cold water supplied up to around 50°C. As a result, the energy required to reach the final rinse temperature (approx. 85°C) is dramatically reduced.

Depending on the model you can save between 3,5kWh and 5,5kWh.

KROMO HR technology improves the room's air quality and climate as well. The heat exchanger reduces the exhaust air temperature by more than an half.









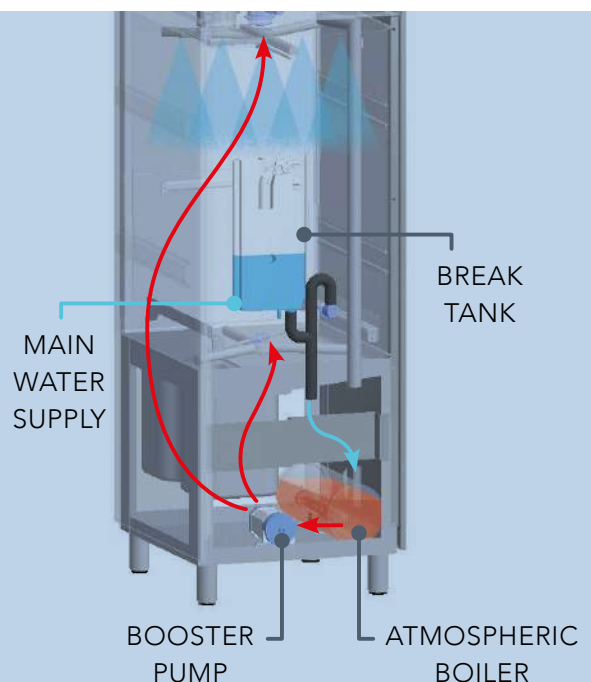

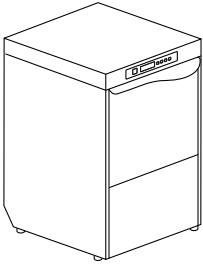





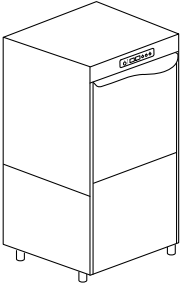

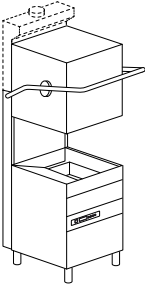

The entire humidity volume is cut down by approx.-20% of the equivalent machine without a heat recovery unit. This permanently improves the operators' comfort.



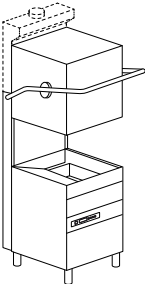



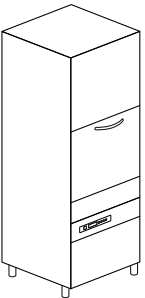



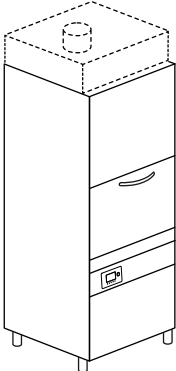

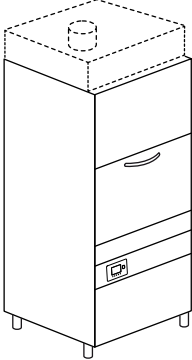
## PLUS SYSTEM

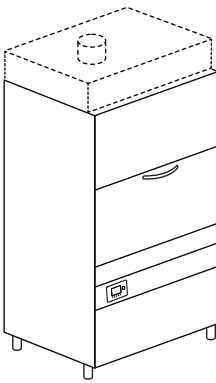
The rinse cycle is stabilized at 85°C temperature and flows at a constant pressure, thanks to the atmospheric boiler which avoids to add fresh water from the mains, when rinsing. Moreover the PLUS System grants a better control and a correct dosage of rinse-aid at every cycle.

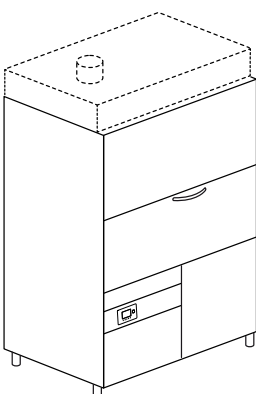

Model		Voltage	Capacity	Dimensions	Code
<b>KP 76 EL 4 PROGRAMS</b>					
	<p><b>RACK EQUIPMENT</b></p> <ul style="list-style-type: none"> <li>1 X 575005</li> <li>1 X C44</li> <li>1 X C86/A</li> <li>1 X 575010</li> </ul>	<p>Multivoltage</p> <p>Standard 400 V 3N 50 Hz 6,7 kW</p> <p>or 230 V 3 50 Hz 6,7 kW</p> <p>or 230 V 50 Hz 6,7 kW</p>	<p> 400 H</p> <p> Ø 400</p> <p> 500x500</p>	<p>600 x 680 x 850 H 68 kg</p> <p> 600 x 400 x 25 H</p> <p> 600 x 400 x 400 H</p>	<p><b>KP 76 EL</b></p> <p><b>KP 76 EL DA</b></p> <p>Surface filters</p>
<b>KP 86 EL PLUS 4 PROGRAMS</b>					
	<p><b>RACK EQUIPMENT</b></p> <ul style="list-style-type: none"> <li>1 X 575005</li> <li>1 X 575010</li> <li>1 X C132</li> <li>1 X C86/A</li> </ul>	<p>400 V 3N ~ 50 Hz 10,2 kW</p>	<p> 440 H</p> <p> 500x500</p> <p> 500x610</p>	<p>600 x 700 x 1380 H</p> <p>100 kg</p> <p> 600x400x25 H</p>	<p><b>KP 86 EL PLUS</b></p>
<b>KP 136 EL PLUS 4 PROGRAMS - HR: HEAT RECOVERY</b>					
	<p><b>RACK EQUIPMENT</b></p> <ul style="list-style-type: none"> <li>1 X 11600054</li> <li>1 X C44</li> <li>1 X C86/A</li> </ul>	<p>400 V 3N ~ 50 Hz 10,49 kW</p>	<p> Ø 410</p> <p> 500x600</p>	<p>720 x 735 x 1445/1915 H</p> <p><b>HR:</b> 720 x 735 x 2095 H</p> <p>104 kg</p> <p> 600 x 400 x 25 H (HT tables)</p>	<p><b>KP 136 EL PLUS</b></p> <p><b>KP 136 EL PLUS DA</b></p> <p><b>KP 136 EL PLUS HR</b></p> <p><b>KP 136 EL PLUS HR DA</b></p>
<b>KP 136 EL PLUS LIFT 4 PROGRAMS - HR: HEAT RECOVERY</b>					
	<p><b>RACK EQUIPMENT</b></p> <ul style="list-style-type: none"> <li>1 X 11600054</li> <li>1 X C44</li> <li>1 X C86/A</li> </ul>	<p>400 V 3N ~ 50 Hz 10,49 kW</p>	<p> Ø 410</p> <p> 500x600</p>	<p>720 x 735 x 1445/1915 H</p> <p><b>HR:</b> 720 x 735 x 2095 H</p> <p>104 kg</p> <p> 600 x 400 x 25 H (HT tables)</p>	<p><b>KP 136 EL PLUS LIFT</b></p> <p><b>KP 136 EL PLUS LIFT DA</b></p> <p><b>KP 136 EL PLUS HR LIFT</b></p> <p><b>KP 136 EL PLUS HR LIFT DA</b></p>
<b>KP 151 EL 4 PROGRAMS</b>					
	<p><b>RACK EQUIPMENT</b></p> <ul style="list-style-type: none"> <li>1 X C86/A</li> <li>1 X C87/B</li> <li>1 X C97/A</li> <li>1 X C100</li> </ul>	<p>400 V 3N ~ 50 Hz 8,2 kW</p>	<p> 805 H</p> <p> 550x665</p>	<p>650 x 750 x 1690/2070H</p> <p>110 kg</p>	<p><b>KP 151 EL</b></p>

Model	Voltage	Capacity	Dimensions	Code
<b>KP 152 EL PLUS</b> 4 PROGRAMS - HR: HEAT RECOVERY				
	<p>RACK EQUIPMENT</p> <ul style="list-style-type: none"> <li>1 X C86/A</li> <li>1 X C87/B</li> <li>1 X C97/A</li> <li>1 X C100</li> </ul>	<p>400 V 3N ~ 50 Hz 8,2 kW</p>	 805 H	<p>690x800x1890/2275 H 155 kg</p> <p><b>KP 152 EL PLUS</b></p>
			 550x665	<p>690x800x2165/2275 H 165 kg</p> <p><b>KP 152 EL HR PLUS</b></p>
<b>KP 202 EL PLUS</b> 4 PROGRAMS - HR: HEAT RECOVERY				
	<p>RACK EQUIPMENT</p> <ul style="list-style-type: none"> <li>1 X 91100</li> <li>1 X C86/A</li> <li>1 X C97/A</li> </ul>	<p>400 V 3N ~ 50 Hz 12,5 kW</p>	 645 H	<p>840x885x1790/2050 H 199 kg</p> <p><b>KP 202 EL PLUS</b></p>
			 700x700	<p>840x885x2140 H 215 kg</p> <p><b>KP 202 EL HR PLUS</b></p>
<b>KP 302 EL PLUS</b> 4 PROGRAMS - HR: HEAT RECOVERY				
	<p>RACK EQUIPMENT</p> <ul style="list-style-type: none"> <li>1 X 92100</li> <li>1 X C86/A</li> <li>1 X C97/A</li> </ul>	<p>400 V 3N ~ 50 Hz 13,4 kW</p>	 645 H	<p>990x885x1790/2050 H 221 kg</p> <p><b>KP 302 EL PLUS</b></p>
			 850x725	<p>990x885x2140 H 237 kg</p> <p><b>KP 302 EL HR PLUS</b></p>
<b>KP 402 EL PLUS</b> 4 PROGRAMS - HR: HEAT RECOVERY				
	<p>RACK EQUIPMENT</p> <ul style="list-style-type: none"> <li>1 X 93600</li> <li>1 X C86/A</li> <li>1 X C97/A</li> </ul>	<p>400 V 3N ~ 50 Hz 14,8 kW</p>	 820 H	<p>1490x885x1970/2310 H 320 kg</p> <p><b>KP 402 EL PLUS</b></p>
			 1350x725	<p>1490x885x2320 H 343 kg</p> <p><b>KP 402 EL HR PLUS</b></p>
		<p>400 V 3N ~ 50 Hz 5,8 kW 25 kg/h</p>	 820 H	<p>1490x885x1970/2310 H 320 kg</p> <p><b>KP 402 EL V PLUS</b></p>
			 1350x725	<p>1490x885x2320 H 343 kg</p> <p><b>KP 402 EL V HR PLUS</b></p>

## OPTIONS

Model	220-240 V 50 Hz	380-415 V 3N 50 Hz	220-240V 3 50 Hz	380-415 V 3 50 Hz	60 Hz	440V 3 60Hz	XP Extra Power	PS Drain Pump	SA Automa- tized Drain	CONTROL Substitute remote control panel
<b>KP 76 EL</b>	M	●	M	----	€	----	----	€	----	----
<b>KP 76 EL DA</b>	M	●	M	----	€	----	----	€	----	----
<b>KP 86 EL PLUS</b>	€	●	□	----	€	----	€	€	----	----
<b>KP 136 EL PLUS*</b>	----	●	□	€	€	€	€	€	----	€
<b>KP 136 EL PLUS DA*</b>	----	●	□	€	€	€	€	€	----	€
<b>KP 136 EL PLUS HR*</b>	----	●	□	€	€	€	€	€	----	€
<b>KP 136 EL PLUS HR DA*</b>	----	●	□	€	€	€	€	€	----	€
<b>KP 136 EL PLUS LIFT*</b>	----	●	□	€	€	€	€	€	----	€
<b>KP 136 EL PLUS LIFT DA*</b>	----	●	□	€	€	€	€	€	----	€
<b>KP 136 EL PLUS HR LIFT*</b>	----	●	□	€	€	€	€	€	----	€
<b>KP 136 EL PLUS HR LIFT DA*</b>	----	●	□	€	€	€	€	€	----	€
<b>KP 151 EL*</b>	----	●	□	€	€	----	€	€	----	----
<b>KP 152 EL PLUS</b>	----	●	□	€	€	----	€	€	----	----
<b>KP 152 EL HR PLUS</b>	----	●	□	€	€	----	€	€	----	----
<b>KP 202 EL PLUS</b>	----	●	□	€	€	----	€	€	●	----
<b>KP 202 EL HR PLUS</b>	----	●	□	€	€	----	€	€	●	----
<b>KP 302 EL PLUS</b>	----	●	□	€	€	----	€	€	●	----
<b>KP 302 EL HR PLUS</b>	----	●	□	€	€	----	€	€	●	----
<b>KP 402 EL PLUS</b>	----	●	□	€	€	----	€	€	●	----
<b>KP 402 EL HR PLUS</b>	----	●	□	€	€	----	€	€	●	----
<b>KP 402 EL V PLUS</b>	----	●	□	€	€	----	----	€	●	----
<b>KP 402 EL V HR PLUS</b>	----	●	□	€	€	----	----	€	●	----

- Standard
- Upon request
- Not available
- M** Multivoltage
- DA** Built-in automatic water softener
- V** Steam heated
- \* All models are equipped with double skin, except KP 136 EL PLUS - KP 151 EL
- PLUS** Rinse with constant temperature and stabilized consumption

Water supply 55 °C (not on HR version)

EAC label upon request





Option compatibility to be confirmed by the manufacturer after verification

**HACCP** Software and cables included

**220-240 V 50 HZ** For KP 86 EL PLUS max boiler heating element 6000 W

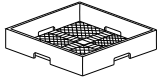
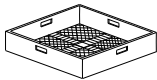
	DDE	DB	DBE	HACCP	CONN.	BT	WRAS	DVGW	PAP	PI	FLOAT
Model	Detergent Dispenser	Rinse-Aid Dispenser	Peristaltic Rinse-Aid Disp.	HACCP supervisor	Connectivity (HACCP)	Break tank	Wras	DVGW	Booster pump	S/S pumps	Probes Lack det. and rinse aid
<b>KP 76 EL</b>	€	●	€	----	€	€	€	€	€	----	€
<b>KP 76 EL DA</b>	€	●	€	----	€	----	€	€	€	----	€
<b>KP 86 EL PLUS</b>	€	----	●	€	----	●	€	€	●	----	€
<b>KP 136 EL PLUS*</b>	€	----	●	----	€	●	€	€	●	----	€
<b>KP 136 EL PLUS DA*</b>	€	----	●	----	€	----	----	----	●	----	€
<b>KP 136 EL PLUS HR*</b>	€	----	●	----	€	●	----	----	●	----	€
<b>KP 136 EL PLUS HR DA*</b>	€	----	●	----	€	----	----	----	●	----	€
<b>KP 136 EL PLUS LIFT*</b>	€	----	●	----	€	●	€	€	●	----	€
<b>KP 136 EL PLUS LIFT DA*</b>	€	----	●	----	€	----	----	----	●	----	€
<b>KP 136 EL PLUS HR LIFT*</b>	€	----	●	----	€	●	----	----	●	----	€
<b>KP 136 EL PLUS HR LIFT DA*</b>	€	----	●	----	€	----	----	----	●	----	€
<b>KP 151 EL*</b>	€	●	€	----	€	----	----	----	●	----	€
<b>KP 152 EL PLUS</b>	€	----	●	----	€	●	€	€	●	----	€
<b>KP 152 EL HR PLUS</b>	€	----	●	----	€	●	----	----	●	----	€
<b>KP 202 EL PLUS</b>	€	----	●	----	€	●	€	€	●	€	€
<b>KP 202 EL HR PLUS</b>	€	----	●	----	€	●	----	----	●	€	€
<b>KP 302 EL PLUS</b>	€	----	●	----	€	●	€	€	●	€	€
<b>KP 302 EL HR PLUS</b>	€	----	●	----	€	●	----	----	●	€	€
<b>KP 402 EL PLUS</b>	€	----	●	----	€	●	€	€	●	----	€
<b>KP 402 EL HR PLUS</b>	€	----	●	----	€	●	----	----	●	----	€
<b>KP 402 EL V PLUS</b>	€	----	●	----	€	----	----	----	●	----	€
<b>KP 402 EL V HR PLUS</b>	€	----	●	----	€	----	----	----	●	----	€

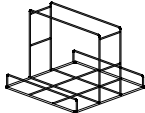
- PS** Not available with 380-415 V 3 50 Hz and 440 V 3 60 Hz
- PI** Available with 50 Hz frequency only
- XP** In case of cold water supply for rinse 8 °C 55 °C, and without any heat recovery, the extra power option is mandatory. + 3000 W with standard voltage only, for other voltages please contact us. In case of cold water supply for rinse 8-15 °C, We recommend the heat recovery option.
- WRAS - DVGW** Booster pump included KP 76 EL machine depth +20 mm
- DVGW** Components prescribed by DVGW on request (check option compatibility with the manufacturer)
- CONNECTIVITY** Includes HACCP option. 10 year plan
- HR** Heat recovery (in case of cold water supply 8-15 °C)  
The ENERGY RECOVERY system uses the heat produced by the machine to preheat the infeed of cold rinse water supply (8-15 °C)  
Optimal air temperature in the dishwashing area thanks to the reduction of the steam and the humidity produced by the machine  
Available in case of osmotic water supply, if the electrical conductivity is higher than 200 microsiemens

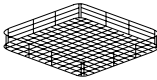
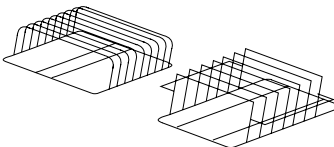
	Description	Capacity	Dimensions	Code	
	NARROW MESH CUTLERY BASKET		500x500x106 H	<b>C 41</b>	
	LARGE MESH BASKET	For glasses	500x500x105 H	<b>C 44</b>	
	REUSABLE CUP BASKET	KP 76 EL KP 86 EL PLUS	500x500x235 H	<b>C 135</b>	
	GRIDDLES Basket holder 2 pcs max depth 80 mm	KP 76 EL KP 86 EL PLUS	500x500x380 H	<b>575005/P</b>	
	GRIDDLES	KP 76 EL KP 86 EL PLUS	500x500	<b>575010</b>	
		KP 151 EL KP 152 EL PLUS	550x550	<b>C 100</b>	
	STAINLESS STEEL BASKETS	KP 86 EL PLUS KP 151 EL - KP 152 EL PLUS KP 202 EL PLUS KP 302 EL PLUS KP 402 EL PLUS	500x610x75 H 550x665x75 H 700x700x130 H 850x725x130 H 1350x725x130 H	<b>C 132</b> <b>C 87/B</b> <b>91100</b> <b>92100</b> <b>93600</b>	
	TRAY SUPPORTS 6 pcs max depth 25 mm	KP 76 EL KP 86 EL PLUS	500x500x160 H	<b>575005</b>	
		KP 136 EL PLUS	500x605x160 H	<b>11600054</b>	

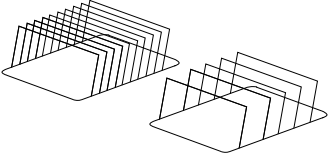
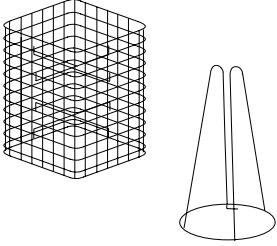
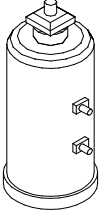
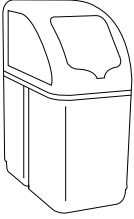
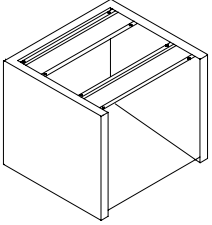
	Description	Capacity	Dimensions	Code	
	TRAY SUPPORTS 8 pcs max depth 25 mm	KP 151 EL KP 152 EL PLUS KP 202 EL PLUS KP 302 EL PLUS KP 402 EL PLUS	300x465x210 H	<b>C 97/A</b>	
	TRAY SUPPORTS 4 pcs max depth 65 mm			<b>C 97/B</b>	
	SPATULA BASKET		150x150x250 H	<b>C 86/A</b>	
			220x220x420 H	<b>C 85/A</b>	
	WATER SOFTENER	12 l	Ø 200x500 H	<b>DEP 12</b>	
	AUTOMATIC WATER SOFTENER	12 l (max 800 l)	315x510x685 H	<b>DEP 12-AUT</b>	
	STAINLESS STEEL STAND	KP 76 E	592x535x500 H	<b>999900517</b>	



Why waste your time with soak and prewash when there are plenty of more useful things to be done in the kitchen? Consider giving a value to wasted hours and the amount of water and detergent used to moisten encrusted pans. Plus the time and effort to scrub, wash and dry them! The conclusion is easily deduced; it's a waste of time, energy and resources. A waste of money. This is when the KROMO GRANULE Utensil Washers enter the

scene. The abrasive power of the projected GRANULE, mixed together with water and detergent, guarantee an excellent result in a few minutes wash. Even with the most tenaciously encrusted pans. A precious and necessary equipment designed to fulfil the needs of canteens, caterers, airports and restaurants' modern kitchens, giving the right value to time and money.



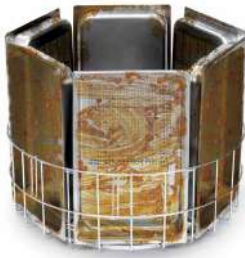

❄ Encrusted pots and pans are often a problem. They require soaking and manual cleaning therefore a waste of time and resources only for this particular task.



🪣 The combined action of water, detergent and granules blasted at high pressure ensures considerable time and energy savings, as well as chemicals, water and electricity. All in favour of our environment.





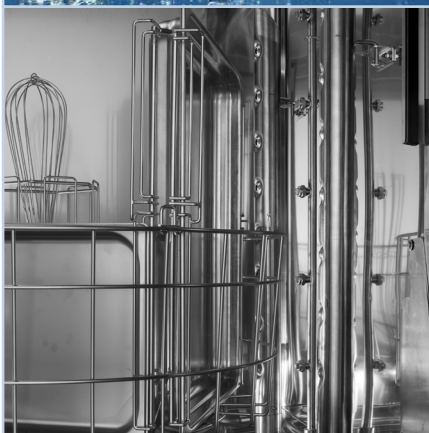



✦ Excellent results against the most stubborn dirt. Moreover, the speedy cycles allow a quick re-use of the kitchenware. The Staff that was previously employed to soak and hand wash, will now be free to perform other tasks.

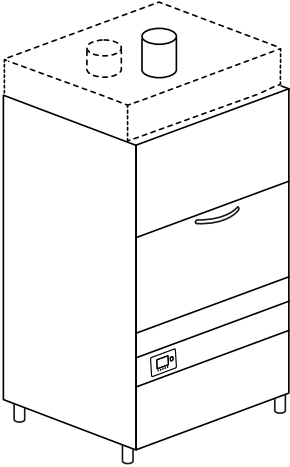

## FEATURES

- The washing system is covered by an International Dual Patent
- Twelve wash cycles, six of which combine water detergent and granules
- Soft-touch panel with multicolour key
- Functional LCD Display for a constant control of all operations
- Multi language control panel
- Double-wall body, fully insulated with high performance thermo-acoustic material
- AISI 316 body and impeller, high performance wash-pump
- Wash-tank in AISI 304 S/S with guaranteed homogeneous thickness
- Double, vertical easy-fit wash-arms, with concave nozzles to prevent clogs and to optimize the combined flow of water and granules
- All electric and electronic components are sheltered in a dedicated box, for easy access from the machine's front
- The round basket is placed on a rotating support stand, to optimise the mechanical action of the granules on the surfaces to wash
- granules collection strainer, with right-level mark for granules
- The resistant lower part of the door becomes a perfect working surface, simplifying the load/unload operations
- The optional service trolley facilitates the loading/unloading of the machine, increasing the operation speed and, consequently, the machine's productivity
- Heat recovery unit, to optimize energy resources and cut down on steam and wamodule

Model	Voltage	Capacity	Dimensions	Code
<b>GR 300 PLUS</b> 12 PROGRAMS				
	<b>PATENTED</b>  400 V 3N ~ 50 Hz 13 kW	6xGN 1/1 ( cycle with GRANULE )	1095x910 1910/2020 H 303 kg	<b>GR 300 PLUS</b>
		10xGN 1/1 ( cycle without GRANULE )		
		 530x325xmax65 H		
		2xGN 2/1  650x530xmax140 H		
		4XEN  600x400x20 H  600x400x50 H	1095x910x2100 H 320 kg	<b>GR 300 HR PLUS</b>
 Ø30 max 50 H Ø40 max 45 H Ø50 max 35 H				

## OPTIONS

Model	220-240 V 50 Hz	380-415 V 3N 50 Hz	220-240 V 3 50 Hz	380-415 V 3 50 Hz	60 Hz	XP Extra Power	PS Drain Pump	DBE Peristaltic Rinse-Aid Disp.
<b>GR 300 PLUS</b>	----	●	□	€	€	€	----	●
<b>GR 300 HR PLUS</b>	----	●	□	€	€	€	----	●
<b>GR 800 HR PLUS</b>	----	●	□	€	€	€	----	●

● Standard

---- Not available







□ Upon request

**XP** In case of cold water supply for rinse 8 °C 55 °C, and without any heat recovery, the extra power option is mandatory.+ 3000 W with standard voltage only, for other voltages please contact us. In case of cold water supply for rinse 8-15 °C, We recommend the heat recovery option.

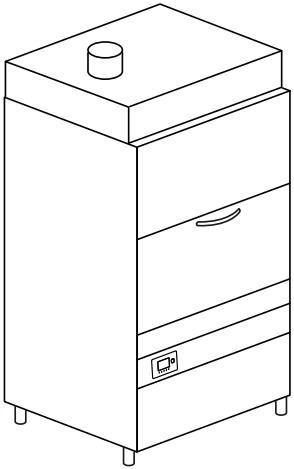
Water supply 55 °C (not on HR version)

EAC label upon request

Option compatibility to be confirmed by the manufacturer after verification

Model	Voltage	Capacity	Dimensions	Code
<b>GR 800 HR PLUS</b> 12 PROGRAMS				
	400 V 3N ~ 50 Hz 13 kW	8xGN 1/1  530x325xmax65 H	1200x1010 2260/2305 H 350 kg	<b>GR 800 HR PLUS</b>
		4xGN 2/1  650x530xmax140 H		
		3XEN  800x600x20 H  800x600x50 H		
		 Ø30 max 60 H Ø40 max 60 H Ø50 max 50 H		



	DDE	PAP	BT	WRAS	DVGW	FLOAT	DWI	PI
Model	Detergent Dispenser	Booster pump	Break tank	Wras	DVGW	Probes Lack det. and rinse aid	Thermoacoustic insulation	S/S pumps
<b>GR 300 PLUS</b>	€	●	●	€	€	€	●	●
<b>GR 300 HR PLUS</b>	€	●	●	----	----	€	●	●
<b>GR 800 HR PLUS</b>	€	●	●	----	----	€	●	●

**BT - WRAS - DVGW** Booster pump included

**DVGW** Components prescribed by DVGW on request (check option compatibility with the manufacturer)

**HR** Heat recovery (in case of cold water supply 8-15 °C)  
 The ENERGY RECOVERY system uses the heat produced by the machine to preheat the infeed of cold rinse water supply (8-15 °C)  
 Optimal air temperature in the dishwashing area thanks to the reduction of the steam and the humidity produced by the machine  
 Available in case of osmotic water supply, if the electrical conductivity is higher than 200 microsiemens

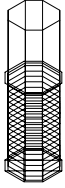
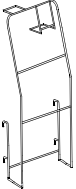
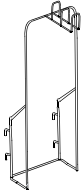
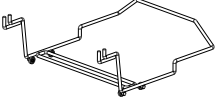
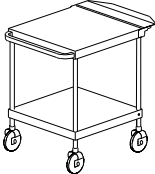
	Description	Capacity	Dimensions	Code	
	ROUND BASKET	Standard equipment for GR 300 Plus  6 pz GN 1/1 o 2 pz GN 2/1	Ø735 x 240 H	<b>96101</b>	
	STAND FOR TRAYS	Standard equipment for GR 300 Plus  10 pz GN 1/1 GASTRONORM max 40 mm		<b>96135</b>	
	STAND FOR TINS	Standard equipment for GR 300 Plus  4 pz 600x400x20 H 4 pz 600x400x50 H EURONORM		<b>96136</b>	
	ROUND BASKET	Standard equipment for GR 800  8 pz GN 1/1 or 4 pz GN 2/1	Ø850 x 350 H	<b>96601</b>	
	SUPPORT	Standard equipment for GR 800 HR Plus	4 pcs (96602) GN 1/1, 2/1  1 pcs (96604) GN 1/1, 2/3, 1/2, 1/3	<b>96602</b>  <b>96604</b>	
	STAND FOR TINS	Standard equipment for GR 800 HR Plus  3 pz 800x600x20 H 3 pz 800x600x50 H EURONORM	600x600x900H 15 kg	<b>96603</b>	

	Description	Capacity	Dimensions	Code	
	SUPPORT	Standard equipment for GR 300 Plus GR 800 HR Plus  Stand for 96103 and pots stand		<b>96102</b>	
	BASKET	Standard equipment for GR 300 Plus GR 800 HR Plus  Spatulas basket		<b>96103</b>	
	SUPPORT	Standard equipment for GR 300 Plus GR 800 HR Plus  Stand for small pots and frying pans		<b>96104</b>	
	SUPPORT	Standard equipment for GR 300 Plus GR 800 HR Plus  Stand for big pots		<b>96105</b>	
	BASKET LIFTER	Standard equipment for GR 300 Plus GR 800 HR Plus  Trolley to easily lift the basket		<b>96605</b>	
	SERVICE TROLLEY	Option equipment for GR 300 Plus GR 800 HR Plus	600x600x900H 15 kg	<b>TROLLEY</b>	
	GRANULE	Standard equipment for GR 300 Plus GR 800 HR Plus  Bucket 12 L	280x280x290H (9 kg)	<b>96100</b>	











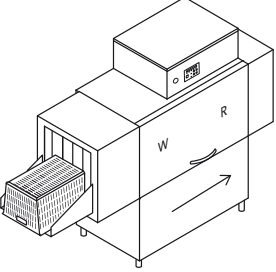

VK models are conceived to wash a large quantity of crates and containers of any kind. They represent the ideal solution for bakeries, pastries and for the general food industry, which require a seamless flow of clean containers. Thanks to all available versions and to the possibility to get personalized configurations, any kind of dirt can be removed. Several options are available, to provide the best fit into the wash area and minimize the need of efforts and labor.

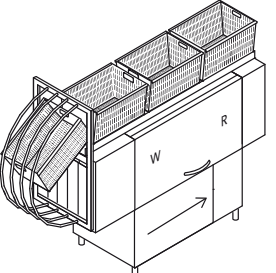
The VK line is designed to provide, mainly in the bakery sector, stunning results at low running costs, allowing remarkable savings under each aspect of its usage. The range is composed of 9 models, all suitable for the general food-industry who needs to wash and sanitize a large number of crates every day. Versatility is one of the most prominent advantages of this line, combined with easy operations and absolute cleanness, according to the strictest hygiene prescriptions.

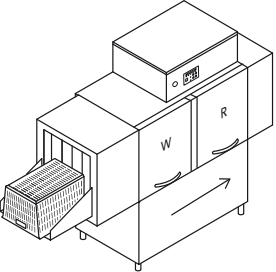

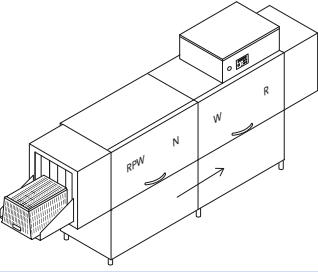

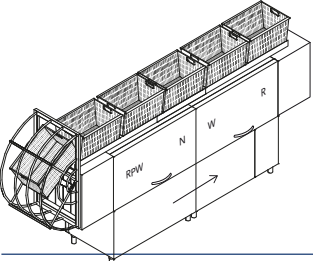

## FEATURES

- Electrical or steam-heated VK 2310, VK 3010 and VK 4010
- Middle-rail system, perfect to wash crates of any width. In addition, our VK 2310 + KP23, VK 3010 + KP23 and VK 4010 + KP23 models are equipped with an innovative top-down loading system allowing a "one-person-only" operation
- **NEW:** five operating speeds
- Double-wall body in stainless steel AISI 304
- ACID PROOF radial wash tanks and boilers in s/s AISI 316; fully insulated boilers to minimize thermal loss
- Self-cleaning vertical wash pumps, protected from electrical overloads
- Double-skin doors with THERMO BARRIER device, insulated and counterbalanced, equipped with anti-fall safety device.
- CLEAN+ surface filters in stainless steel
- Easily removable wash and rinse arms in stainless steel
- S/S adjustable feet
- Inlet chute and splash-guard modules at both ends
- Anti-contamination curtains
- Consumptions economizers
- Electronic panel with IPX5 membrane keyboard, ensuring a constant monitoring of operating parameters
- Autotimer, switching off the rack conveyor motor and all electrical devices after a pre-set lapse of inactivity
- Centralized drain 1-DRAIN for VK 2310 and VK 2810 models

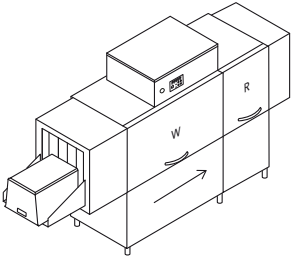
Model	Voltage	Capacity	Dimensions	Code
<b>VK 2310 5 SPEEDS</b>				
<i>IMPROVED</i>				
	400 V 3N ~ 50 Hz 30 kW	 510x500 H	2600x805x1830/2120 H 270 kg	<b>VK 2310</b>
	400 V 3N ~ 50 Hz 2,4 kW 45 kg/h	1,5-2,0 m/min		<b>VK 2310 V</b>
<b>VK 2310 + KP23 5 SPEEDS - Upper loading system</b>				
<i>IMPROVED</i>				
	400 V 3N ~ 50 Hz 30 kW	 510x500 H	2710x805x2075/2120 H 280 kg	<b>VK 2310 + KP23</b>
		1,5-2,0 m/min		
<b>VK 2810 5 SPEEDS</b>				
<i>IMPROVED</i>				
	400 V 3N ~ 50 Hz 33 kW	 510x800 H	2800x805x2130/2720 H 310 kg	<b>VK 2810</b>
		1,5-2,0 m/min		
<b>VK 3010 - VK 4010 5 SPEEDS</b>				
<i>IMPROVED</i>				
	400 V 3N ~ 50 Hz 37 kW 3,7 kW - 54 kg/h	 510x500 H	4100x805x1830/2120 H 455 kg	<b>VK 3010</b>
	400 V 3N ~ 50 Hz 41 kW	2,0-2,6 m/min (VK 3010)		<b>VK 3010 V</b>
	4,6 kW - 59 kg/h	2,6-4,0 m/min (VK 4010)		<b>VK 4010</b>
			<b>VK 4010 V</b>	
<b>VK 3010 + KP23 - VK 4010 + KP23 5 SPEEDS - Upper loading system</b>				
<i>IMPROVED</i>				
	400 V 3N ~ 50 Hz 37 kW	 510x500 H	4210x805x2075/2120 H 505 kg	<b>VK 3010 + KP23</b>
		2,0-2,6 m/min (VK 3010)		<b>VK 4010 + KP23</b>
	400 V 3N ~ 50 Hz 41 kW	2,6-4,0 m/min (VK 4010)		

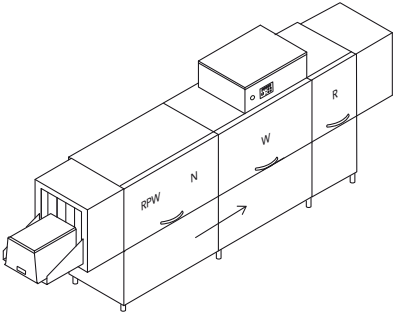

Model	Voltage	Capacity	Dimensions	Code
<b>VK 2510</b> 5 SPEEDS - Upper loading system				
<i>IMPROVED</i>				
	400 V 3N ~ 50 Hz 30 kW	 510x500 H 1,5-2,0 m/min	3200x805x1830/2120 H 270 kg	<b>VK 2510</b>
<b>VK 3510</b> 5 SPEEDS - Upper loading system				
<i>IMPROVED</i>				
	400 V 3N ~ 50 Hz 37 kW	 510x500 H 2,0-2,6 m/min	4700x805x1830/2120 H 455 kg	<b>VK 3510</b>

- W** Wash
- R** Single rinse
- N** Neutral zone
- RPW** Reinforced prewash
- V** Steam-heated

EAC label upon request

Option compatibility to be confirmed by the manufacturer after verification

	H max	min < L1 < max	min < L2 < max	Depth max
<b>VK 2310 - VK 3010 - VK 4010</b>	500	400 < L1 < 510	400* < L2 < 510	600
<b>VK 3010 - VK 4010 + DRYER</b>	500	400 < L1 < 510	400* < L2 < 510	600
<b>VK 2810</b>	800	400 < L1 < 510	400* < L2 < 510	600
<b>VK 2310 + KP23 - VK 3010 + KP23 - VK 4010 + KP23</b>	500	400 < L1 < 470	400* < L2 < 510	600
<b>VK 2510 - VK 351</b>	500	400 < L1 < 510	400* < L2 < 510	600

\* Verify with the manufacturer

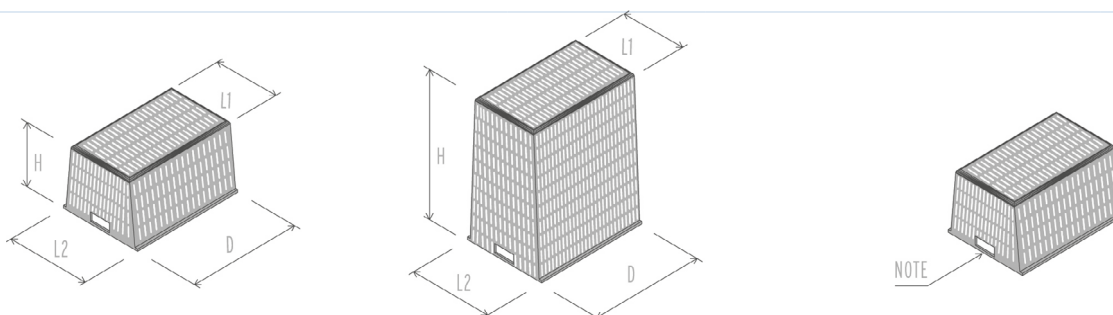

**NOTE:** Should you need to wash baskets with non-standard handles or dimensions, please contact our technical department

## OPTIONS

			XP	DDE-GROUP	PI	DRIVE	AUTOTIMER
	220-240 V 3 50 Hz	60 Hz	Extra Power	Dispensers kit	S/S pumps	Smart drive	Autotimer
<b>VK 2310</b>	€	+ 3%	€	€	€	€	●
<b>VK 2310 V</b>	€	+ 3%	----	€	€	€	●
<b>VK 2310 + KP23</b>	€	+ 3%	€	€	€	€	●
<b>VK 2810</b>	€	+ 3%	€	€	€	€	●
<b>VK 3010</b>	€	+ 3%	€	€	€	€	●
<b>VK 3010 V</b>	€	+ 3%	----	€	€	€	●
<b>VK 3010 + KP23</b>	€	+ 3%	€	€	€	€	●
<b>VK 4010</b>	€	+ 3%	€	€	€	€	●
<b>VK 4010 V</b>	€	+ 3%	----	€	€	€	●
<b>VK 4010 + KP23</b>	€	+ 3%	€	€	€	€	●
<b>VK 2510</b>	€	+ 3%	€	€	€	€	●
<b>VK 3510</b>	€	+ 3%	€	€	€	€	●

● Standard

---- Not available

**DDE-GROUP** Both detergent (with probe) and rinse-aid dispensers included

**PI** Available with 50 Hz frequency only

**DRIVE** Check voltage compatibility

Water supply 55 °C

We recommend to install the machine in a well ventilated room, with a properly sized steam exhausting system

Option compatibility to be confirmed by the manufacturer after verification

	DOS/S	PAP	DIV	1-DRAIN	DWI	BT	DVGW
	Dispenser with probe	Booster pump	Price for division	Centralized Drain	Thermoacoustic insulation	Break tank	DVGW
<b>VK 2310</b>	€	€	€	●	€	€	€
<b>VK 2310 V</b>	€	€	€	●	€	€	€
<b>VK 2310 + KP23</b>	€	€	€	●	€	€	€
<b>VK 2810</b>	€	€	€	●	€	€	€
<b>VK 3010</b>	€	€	€	€	€	€	€
<b>VK 3010 V</b>	€	€	€	€	€	€	€
<b>VK 3010 + KP23</b>	€	€	€	€	€	€	€
<b>VK 4010</b>	€	€	€	€	€	€	€
<b>VK 4010 V</b>	€	€	€	€	€	€	€
<b>VK 4010 + KP23</b>	€	€	€	€	€	€	€
<b>VK 2510</b>	€	€	€	●	€	€	€
<b>VK 3510</b>	€	€	€	€	€	€	€

- DOS/S** Only for detergent dispenser
- DWI** Insulation option for the tunnel only, dryer excluded. Recommended with KHR10 – KHR20 – KHRP40
- BT** Booster pump included
- DVGW** Not available with heat recovery and steam condenser  
Components prescribed by DVGW on request (check option compatibility with the manufacturer)
- + KP23** Upper sliding support for crates with maximum width 475 mm

### OPTIONS

	KDR94	KDR99	KDR9V	KTB94	KTB99	KTB9V
Model	Dryer + 700 mm / 4,5 kW	Dryer + 700 mm / 9 kW	Steam dryer + 700 mm	Dryer on module with blowers	Dryer on module with blowers	Steam dryer on module with blowers
<b>VK 2310</b>	€	€	----	€	€	----
<b>VK 2310 V</b>	----	----	€	----	----	€
<b>VK 2310 + KP23</b>	----	----	----	----	----	----
<b>VK 2810</b>	----	----	----	----	----	----
<b>VK 3010</b>	€	€	----	€	€	----
<b>VK 3010 V</b>	----	----	€	----	----	€
<b>VK 3010 + KP23</b>	----	----	----	----	----	----
<b>VK 4010</b>	€	€	----	€	€	----
<b>VK 4010 V</b>	----	----	€	----	----	€
<b>VK 4010 + KP23</b>	----	----	----	----	----	----
<b>VK 2510</b>	€	€	----	€	€	----
<b>VK 3510</b>	€	€	----	€	€	----

- Standard
- Not available

**ALL DRYERS** Ask the producer for effectiveness on drying results according to the basket to wash. The insulation of the dryers is not available

**KDR94** With VK 3010, VK 4010, VK 3510, optional not ideal, verify with manufacturer

With osmotic water supply and electrical conductivity lower than 200 microsiemens, it is mandatory to install a stainless steel heat exchanger

Option compatibility to be confirmed by the manufacturer after verification

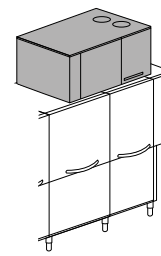
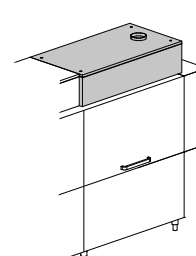
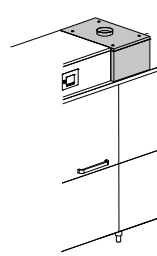
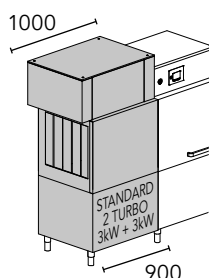
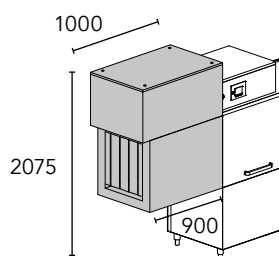

**KDR94** 4,5 kW

**KDR99** 9 kW

Dryer

**KDR9V**

Steam-heated dryer

**KTB94** 11,6 kW

**KTB99** 16,1 kW

Dryer on module with blowers

**KTB9V** 7,1 Kw

Steam-heated dryer on module with blowers

**KSC10**

Steam condenser

**KHR10**

Compact heat recovery

**KHR20**

heat recovery

**KHRP40**

Heat recovery with heat pump

	KDR54	KDR59	KSC10	KHR10	KHR20	KHRP40
Model	Dryer 4,5 kW	Dryer 9 kW	Steam condenser	heat recovery	heat recovery	heat recovery
<b>VK 2310</b>	----	----	€	€	----	----
<b>VK 2310 V</b>	----	----	€	€	----	----
<b>VK 2310 + KP23</b>	----	----	----	----	----	----
<b>VK 2810</b>	€	€	€	€	----	----
<b>VK 3010</b>	----	----	€	€	€	€
<b>VK 3010 V</b>	----	----	€	€	€	€
<b>VK 3010 + KP23</b>	----	----	----	----	----	----
<b>VK 4010</b>	----	----	€	€	€	€
<b>VK 4010 V</b>	----	----	€	€	€	€
<b>VK 4010 + KP23</b>	----	----	----	----	----	----
<b>VK 2510</b>	----	----	€	€	----	----
<b>VK 3510</b>	----	----	€	€	€	€

**KHR10 - KHR20 -  
KHRP40**

In case of cold water supply for rinse (8-15 °C), we recommend to install the heat recovery system optional.

**XP**

In case of cold water supply for rinse 8 °C 55 °C, and without any heat recovery, the extra power option is mandatory. In case of cold water supply for rinse 8 °C 55 °C, we recommend the heat recovery option.

We strongly recommend the presence of a roller table with end microswitch at the exit of our rack conveyor machines for a correct operation

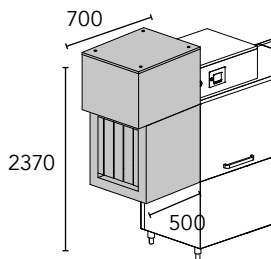

**KDR54** 4,5 kW

**KDR59** 9 kW

Dryer

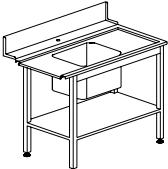
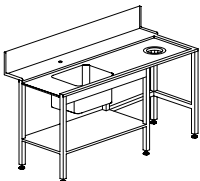
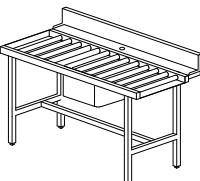
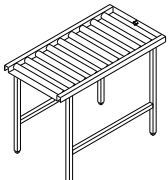
	Description	Capacity	Dimensions	Code	
	TABLE + SINK	Sink 500x400x270 H	1200x730x860 H	<b>K 55</b>	
	TABLE + SINK	Sink 500x400x270 H	1500x730x860 H	<b>K 8</b>	
		Standard rubber ring	1800x730x860 H	<b>K 9</b>	
	ROLLER TABLE + sink, right or left version	Sink 500x400x270 H	1600x730x860 H	<b>K 195</b>	
	LINEAR ROLLER TABLE WITH TANK		1100x650x860 H	<b>K 19*</b>	
			1600x650x860 H	<b>K 19/B*</b>	
			2100x650x860 H	<b>K 19/C*</b>	
		Option end microswitch		<b>K 18</b>	

\* Wooden cage +2% minimum + €

Special dimensions for tables upon request

Tables shown in right-to-left version

We strongly recommend the presence of a roller table with end microswitch at the exit of our pull-through create washers for a correct operation





KROMO conveyor crate-washers are the perfect answer for all those sectors in the food industry dealing with heavy workloads on a daily basis: large bakeries and pastry shops, meat or fish industry, catering services, commercial kitchens, airport facilities.

Our LK and LK-HD lines have been designed to offer our clients a comprehensive solution, tailored to their needs and work habits.

Our conveyor crate-washers line offers the possibility to choose among six highly customizable models, which however maintain some of the distinctive features of the KROMO brand, such as the usable belt width of 640 mm, usable height of 450 mm and a constant monitoring of operation temperatures and wash results.

All this while preserving limited dimensions, lower than the market average at an equal production capacity: with LK and LK-HD machines it is possible to wash even big or non-standard baskets, thanks to the addition of dedicated neutral zones between modules. Optimal wash results are always Kromo's main goal. What else to say, other than just try our LK and LK-HD models?



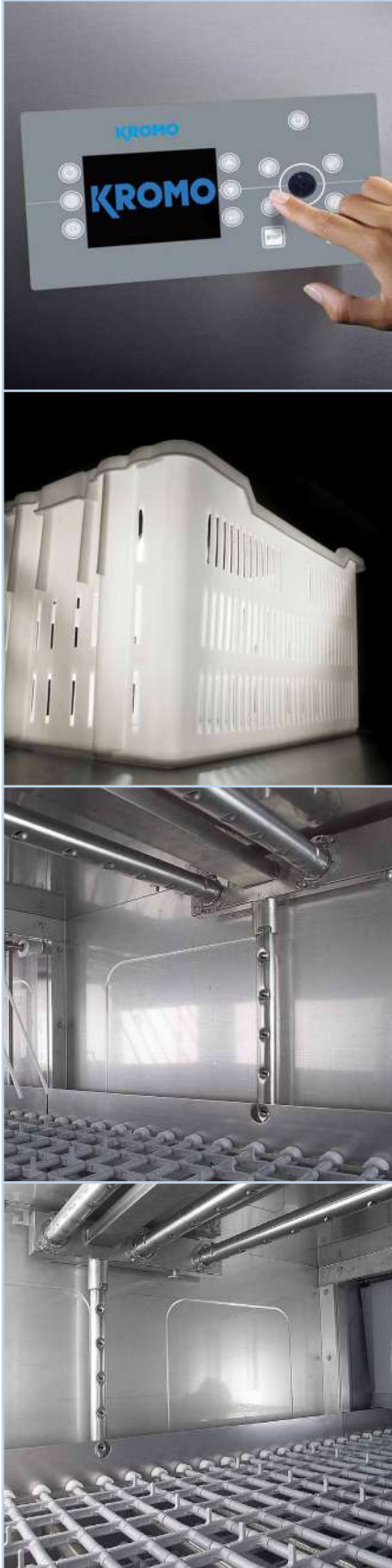

## FEATURES

### STANDARD

- SMART DRIVE 5-speed advancement system
- 710 mm wide conveyor with usable width of 640 mm
- Standard crates belt
- TFT 5.7" display and soft touch keyboard
- Frequently used keys shortcut and menu language setting
- Constant monitoring of key operations
- IPX5 electronic board
- Alarms and events report
- Autotimer
- Centralized 1-DRAIN and automatic AD drain, with total or partial emptying of the tanks
- Independent and adjustable wash arms
- Use economizers
- ECO-DET Detergent economizer
- ACID PROOF Radial wash tanks in AISI 316 stainless steel inclined to provide complete drainage of the wash water
- ACID PROOF stainless steel boilers in AISI 316, fully insulated to reduce thermal loss
- S/S surface filters CLEAN+ to protect the wash tanks as well as the wash pump
- Double-skin, insulated and counterbalanced doors, equipped with anti drop safety system
- THERMO BARRIER system for comfort in use
- Predisposition for KROMO rinse-aid and detergent dispensers connection
- Vertical self-cleaning pumps
- Reinforced double rinse 2R+, improved efficiency with lower consumption
- CPF System: Controlled Pressure Flow
- Water, energy consumptions and working time control system
- Possible working modes for dryer unit: all off, only fan, half power 4,5 kW + fan, total power 9 kW + fan
- Peak-cut for dosing included
- Estimated consumption readout

### THERMO BARRIER

Our state of the art doors offer three main advantages: improved insulation of the washing chamber to maintain a constant temperature, reduction of power consumptions for boiler heating elements, and a decrease of humid vapour dispersed in the environment.

### ACID PROOF

Our machines benefit from maximum protection against aggressive cleaning agents and salty water, thanks to the special composition and quality of the steel used for construction, both outdoing market standards. AISI 316 steel is indeed mainly employed in specific conditions of temperature and chemicals concentrations.

### CLEAN+

The tank filtration system by KROMO ensures three protection modules: the first removing persistent dirt, the second on the overall tank to prevent water contamination and a third filter system to protect components.

### CPF

This simple device allows to easily adjust water pressure in the prewash or wash phase in accordance to one's needs. By pulling the dedicated lever, it is possible to decrease water flow through nozzles of upper/lower wash arms.

### OPTIONS

- Double belt or lower belt conveyor available
- Double skin shelf or dryer module
- Steam condenser
- 3 models of heat recovery to be chosen
- Dispensers kit with peristaltic pump, for detergent as well as rinse-aid
- Delivery in 2 or more parts, to ease installation operations
- Automatic self-cleaning of the machine available, with dedicated booster pump on request
- Thermal and acoustic insulation
- Tank insulation
- Heavy duty belt
- Break tank and booster pump
- Dedicated space for detergent and rinse-aid jugs
- S/S pumps
- Extra power in the boiler
- CONNECTIVITY remote control compliant with the HACCP norms

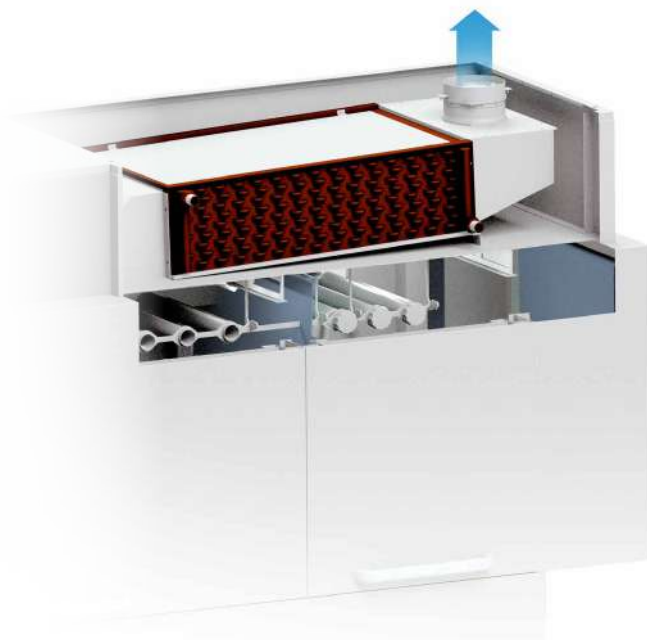

## CONNECTIVITY 4.0 & APP

WHEREVER YOU ARE...

YOUR DISHWASHER, JUST A CLICK AWAY

You will be constantly connected to the machine to monitor the work phases, review any eventual alarm and configure remotely the operating parameters according to your needs. Compliant with HACCP norms. Thanks to our brand new App, you will have access to connected machines and all commercial and technical documentation.

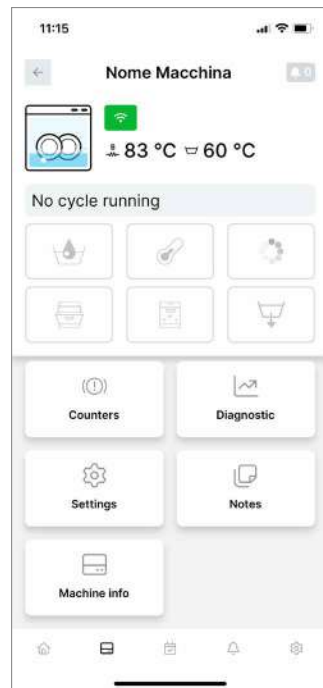

View all the working parameters and event records, working hours and any problem at any time.











In case of problem, the machine promptly alerts you. The technician can intervene remotely to solve the problem or anticipate the needed parts for an on-site intervention.

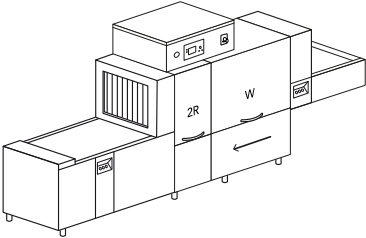

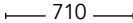
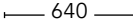
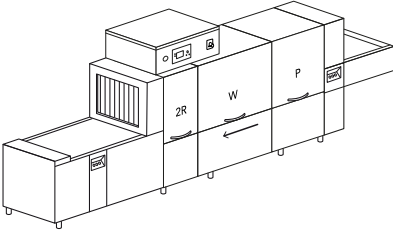

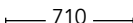
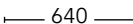
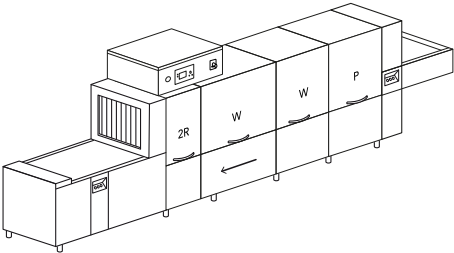

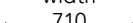
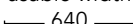
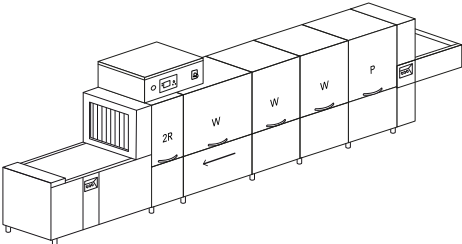
A daily activity report is available with all the events related to the dishwasher in a detailed spreadsheet with HACCP data.

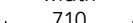
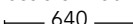

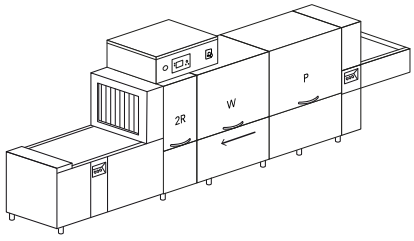
Our Connectivity system is a revolutionary device limiting and facilitating the eventual intervention of a technician who can anticipate the necessary parts to be replaced, saving time and money.

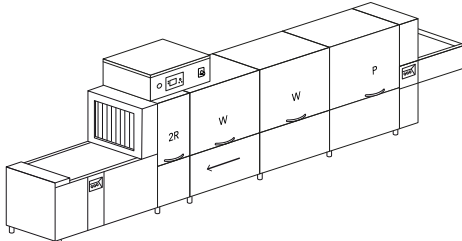
Model	Voltage	Capacity	Dimensions	Code
<b>LK 5010</b> 5 SPEEDS				
	400 V 3N ~ 50 Hz 31,5 kW	 640x450 H	4900x985x1860/2200 H 625 kg	<b>LK 5010</b>
	400 V 3N ~ 50 Hz 2,5 kW 48 kg/h	belt width  710  usable width  640  2,20-3,45 m/min		<b>LK 5010 V</b>
<b>LK 7510</b> 5 SPEEDS				
	400 V 3N ~ 50 Hz 36,5 kW	 640x450 H	5800x985x1860/2200 H 775 kg	<b>LK 7510</b>
	400 V 3N ~ 50 Hz 4,5 kW 52 kg/h	belt width  710  usable width  640  3,25-5,10 m/min		<b>LK 7510 V</b>
<b>LK 10010</b> 5 SPEEDS				
	400 V 3N ~ 50 Hz 56,5 kW	 640x450 H	6700x985x1860/2200 H 925 kg	<b>LK 10010</b>
	400 V 3N ~ 50 Hz 6,5 kW 82 kg/h	belt width  710  usable width  640  4,45-6,95 m/min		<b>LK 10010 V</b>
<b>LK 12510</b> 5 SPEEDS				
	400 V 3N ~ 50 Hz 74,5 kW	 640x450 H	7600x985x1860/2200 H 1075 kg	<b>LK 12510</b>
	400 V 3N ~ 50 Hz 8,5 kW 108 kg/h	belt width  710  usable width  640  5,27-8,23 m/min		<b>LK 12510 V</b>

Model	Voltage	Capacity	Dimensions	Code
<b>LK 8510 HD 5 SPEEDS</b>				
	400 V 3N ~ 50 Hz 34,92 kW	 640x450 H  belt width 710	6200x985x1860/2200 H 790 kg	<b>LK 8510 HD</b>
	400 V 3N ~ 50 Hz 4,42 kW 50 kg/h	usable width 640  1,4-2,15 m/min		<b>LK 8510 HD V</b>
<b>LK 11010 HD 5 SPEEDS</b>				
	400 V 3N ~ 50 Hz 52,42 kW	 640x450 H  belt width 710	7500x985x1860/2200 H 1050 kg	<b>LK 11010 HD</b>
	400 V 3N ~ 50 Hz 6,42 kW 76 kg/h	usable width 640  1,95-3 m/min		<b>LK 11010 HD V</b>

- P** Prewash
- W** Power wash
- 2R** Pre-rinse + rinse on module
- V** Steam supply

Option compatibility to be confirmed by the manufacturer after verification

## OPTIONS

Model	220-240 V 3 50 Hz	380-415 V 3N 50 Hz	60 Hz	PRE DOS Kromo disp. connections	DDE-GROUP Dispensers kit	DOS/S Dispenser with probe	SAN Sanitization System	PAP-SAN Booster Pump Sanitiz.	DWI Thermoacoustic insulation
<b>LK 5010</b>	+ 2%	●	+ 3%	●	€	€	€	€	€
<b>LK 5010 V</b>	+ 1%	●	+ 3%	●	€	€	€	€	€
<b>LK 7510</b>	+ 2%	●	+ 3%	●	€	€	€	€	€
<b>LK 7510 V</b>	+ 1%	●	+ 3%	●	€	€	€	€	€
<b>LK 10010</b>	+ 2%	●	+ 3%	●	€	€	€	●	€
<b>LK 10010 V</b>	+ 1%	●	+ 3%	●	€	€	€	●	€
<b>LK 12510</b>	+ 2%	●	+ 3%	●	€	€	€	●	€
<b>LK 12510 V</b>	+ 1%	●	+ 3%	●	€	€	€	●	€
<b>LK 8510 HD</b>	+ 2%	●	+ 3%	●	€	€	€	€	€
<b>LK 8510 HD V</b>	+ 1%	●	+ 3%	●	€	€	€	€	€
<b>LK 11010 HD</b>	+ 2%	●	+ 3%	●	€	€	€	●	€
<b>LK 11010 HD V</b>	+ 1%	●	+ 3%	●	€	€	€	●	€

- Standard
- Upon request
- DDE-GROUP** Both detergent (with probe) and rinse-aid dispensers included
- PAP-SAN** Standard pump for models LK 10010, LK 12510, LK 11010 HD
- DIV** Compulsory for machines > 4,5 m
- BT** Booster pump included
- CONNECTIVITY** Includes HACCP option. 10 year plan
- DWI** Insulation option for the tunnel only, dryer excluded. Shelf dryer can be double skin upon request
- DWI-DWI/T** Recommended for KHRF10 - KHRF20 - KHRPF40
- XP** In case of cold water supply for rinse 8 °C 55 °C, and without any heat recovery, the extra power option is mandatory  
In case of cold water supply for rinse (8-15 °C), we recommend to install the heat recovery system optional.

EAC label upon request

Option compatibility to be confirmed by the manufacturer after verification

	DWI / T	CONNECTIVITY	XP	PAP	DRIVE	PI	1-DRAIN	ECO-DET	X-BELT	DIV	BT
Model	Tank insulation	Connectivity (HACCP)	Extra Power	Booster pump	Smart drive	S/S pumps	Centralized Drain	Detergent economizer	Special belt	Price for division	Break tank
<b>LK 5010</b>	€	€	€	€	●	€	●	●	+ 7%	€	€
<b>LK 5010 V</b>	€	€	□	€	●	€	●	●	+ 7%	€	€
<b>LK 7510</b>	€	€	€	€	●	€	●	●	+ 7%	€	€
<b>LK 7510 V</b>	€	€	€	€	●	€	●	●	+ 7%	€	€
<b>LK 10010</b>	€	€	€	€	●	€	●	●	+ 7%	€	€
<b>LK 10010 V</b>	€	€	€	€	●	€	●	●	+ 7%	€	€
<b>LK 12510</b>	€	€	€	€	●	€	●	●	+ 7%	€	€
<b>LK 12510 V</b>	€	€	□	€	●	€	●	●	+ 7%	€	€
<b>LK 8510 HD</b>	€	€	€	€	●	€	●	●	+ 7%	€	€
<b>LK 8510 HD V</b>	€	€	€	€	●	€	●	●	+ 7%	€	€
<b>LK 11010 HD</b>	€	€	€	€	●	€	●	●	+ 7%	€	€
<b>LK 11010 HD V</b>	€	€	€	€	●	€	●	●	+ 7%	€	€

## OPTIONS

Model	NZ3 Neutral zone 300	NZ6 Neutral zone 600	NZH6 Neutral zone for dryer 600	KDRF69 Shelf dryer	KDRF6V Steam-heated shelf dryer	ID Double skin for shelf dryer	KDRF99M Module dryer	KDRF9VM Steam heated dryer module	KDRF99MB Dryer on module with blowers	KDRF99MB1 Dryer on module with blowers
<b>LK 5010</b>	€	€	€	€	----	€	€	----	€	€
<b>LK 5010 V</b>	€	€	€	€	€	€	€	€	€	€
<b>LK 7510</b>	€	€	€	€	----	€	€	----	€	€
<b>LK 7510 V</b>	€	€	€	€	€	€	€	€	€	€
<b>LK 10010</b>	€	€	€	€	----	€	€	----	€	€
<b>LK 10010 V</b>	€	€	€	€	€	€	€	€	€	€
<b>LK 12510</b>	€	€	€	€	----	€	€	----	€	€
<b>LK 12510 V</b>	€	€	€	€	€	€	€	€	€	€
<b>LK 8510 HD</b>	€	€	€	€	----	€	€	----	€	€
<b>LK 8510 HD V</b>	€	€	€	€	€	€	€	€	€	€
<b>LK 11010 HD</b>	€	€	€	€	----	€	€	----	€	€
<b>LK 11010 HD V</b>	€	€	€	€	€	€	€	€	€	€

---- Not available

**NZ3** Recommended to wash long baskets

**NZ6** Recommended for big quantities of trays to wash. Module equipped with a front door

**NZH6** Recommended with dryers with blowers

**U-AIR** Proximity air nozzles available on every dryer module

**ID** Recommended option for KDRF69 - KDRF6V. Only for dryer on shelf

With osmotic water supply and electrical conductivity lower than 200 microsiemens, it is mandatory to install a stainless steel heat exchanger

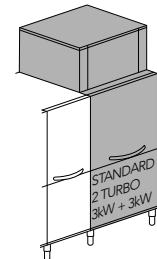
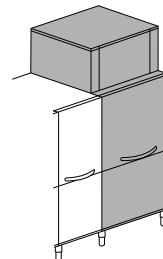
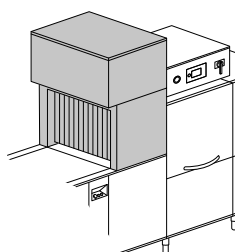
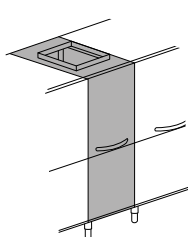
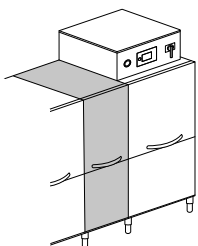

**NZ3** + 300 mm

Neutral zone

**NZH6** + 600 mm

Neutral zone with door  
for dryer

**KDRF69** 9 kW

Shelf dryer

**KDRF99M** + 900 mm - 9 kW

Dryer module

**KDRF99MB** + 900 mm 16,1 kW

Dryer module

**NZ6** + 600 mm

Neutral zone with door

**KDRF6V**

Steam-heated shelf dryer

**KDRF9VM** + 900 mm

Steam-heated dryer module

**KDRF9VMB** + 900 mm 7,1 kW

Steam-heated dryer module



Model	KDRF99MB2	KDRF9VMB	KDRF9VMB1	KDRF9VMB2	U-AIR	KSCF10	KHRF10	KHRF20	KHRPF40	3R	STOCK	HD+BELT
	Dryer on module with blowers	Steam dryer on module with blowers	Steam dryer on module with blowers	Steam dryer on module with blowers	Proximity air nozzle	Steam condenser	heat recovery	heat recovery	heat recovery	Triple rinse	Chemicals compartment	Heavy-duty belt
<b>LK 5010</b>	€	----	----	----	€	€	€	----	€	€	€	€
<b>LK 5010 V</b>	€	€	€	€	€	€	€	----	€	€	€	€
<b>LK 7510</b>	€	----	----	----	€	€	€	€	€	€	€	€
<b>LK 7510 V</b>	€	€	€	€	€	€	€	€	€	€	€	€
<b>LK 10010</b>	€	----	----	----	€	€	€	€	€	€	€	€
<b>LK 10010 V</b>	€	€	€	€	€	€	€	€	€	€	€	€
<b>LK 12510</b>	€	----	----	----	€	€	€	€	€	€	€	€
<b>LK 12510 V</b>	€	€	€	€	€	€	€	€	€	€	€	€
<b>LK 8510 HD</b>	€	----	----	----	€	€	€	€	€	€	€	€
<b>LK 8510 HD V</b>	€	€	€	€	€	€	€	€	€	€	€	€
<b>LK 11010 HD</b>	€	----	----	----	€	€	€	€	€	€	€	€
<b>LK 11010 HD V</b>	€	€	€	€	€	€	€	€	€	€	€	€

### HD+BELT

For each dryer module and neutral zone, the extra price is + €

**KDRF99MB1 - KDRF9VMB1** Lower by-pass belt with blowers. Maximum 1 per machine as an alternative to the double belt

**KDRF99MB2 -KDRF9VMB2** Double belt with blowers. Maximum 1 per machine as an alternative to the lowered by-pass belt

**KHRF10-KHRF20-KHRPF40**In case of cold water supply for rinse (8-15 °C), we recommend to install the heat recovery system optional.

Option compatibility to be confirmed by the manufacturer after verification

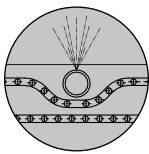

with blowers and lowered belt

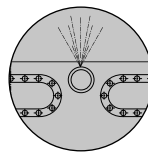

with blowers and double belt

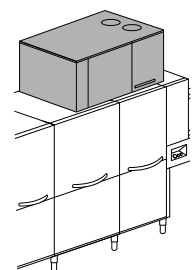
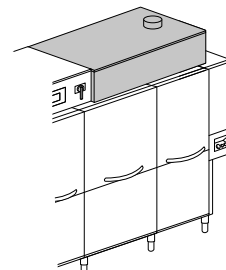
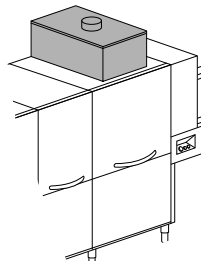
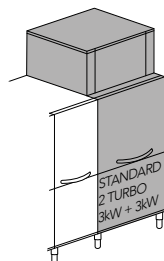
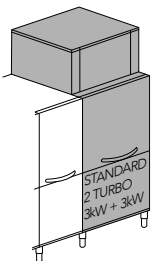

**KDRF99MB1** + 900 mm 16,1 kW

Dryer module

**KDRF99MB2** + 900 mm 16,1 kW

Dryer module

**KHRF10**

Compact heat recovery

**KHRF20**

heat recovery

**KHRPF40**

Heat recovery with heat pump

**KDRF9VMB1** + 900 mm 7,1 kW

Steam-heated dryer module

**KDRF9VMB2** + 900 mm 7,1 kW

Steam heated dryer module

**KSCF10**

Steam condenser

## OPTIONS

	MI900	MI1200	MIS1200	MI1500	MI1800	MI2200	MI2700
Model	Entry mod. 900	Entry mod. 1200	Over. entry mod. 1200	Entry mod. 1500	Entry mod. 1800	Entry mod. 2200	Entry mod. 2700
<b>LK 5010</b>	€	€	●	€	€	€	€
<b>LK 5010 V</b>	€	€	●	€	€	€	€
<b>LK 7510</b>	€	€	●	€	€	€	€
<b>LK 7510 V</b>	€	€	●	€	€	€	€
<b>LK 10010</b>	€	€	●	€	€	€	€
<b>LK 10010 V</b>	€	€	●	€	€	€	€
<b>LK 12510</b>	€	€	●	€	€	€	€
<b>LK 12510 V</b>	€	€	●	€	€	€	€
<b>LK 8510 HD</b>	€	€	●	€	€	€	€
<b>LK 8510 HD V</b>	€	€	●	€	€	€	€
<b>LK 11010 HD</b>	€	€	●	€	€	€	€
<b>LK 11010 HD V</b>	€	€	●	€	€	€	€

- Standard
- Upon request
- Not available

Option compatibility to be confirmed by the manufacturer after verification

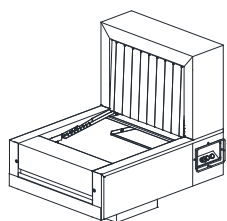

Overhanging entry module

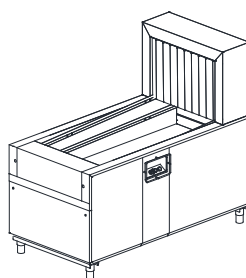

Entry module

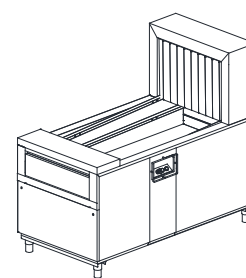

Exit module

	MIR2700	EM900	EM1200	EM1500	EM1800	EM2200	EM2700
Model	Lowered belt entry mod. 2700	Exit mod. 900	Exit mod. 1200	Exit mod. 1500	Exit mod. 1800	Exit mod. 2200	Exit mod. 2700
<b>LK 5010</b>	€	□	□	□	●	€	€
<b>LK 5010 V</b>	€	□	□	□	●	€	€
<b>LK 7510</b>	€	□	□	□	●	€	€
<b>LK 7510 V</b>	€	□	□	□	●	€	€
<b>LK 10010</b>	€	□	□	□	●	€	€
<b>LK 10010 V</b>	€	□	□	□	●	€	€
<b>LK 12510</b>	€	□	□	□	●	€	€
<b>LK 12510 V</b>	€	□	□	□	●	€	€
<b>LK 8510 HD</b>	€	□	□	□	●	€	€
<b>LK 8510 HD V</b>	€	□	□	□	●	€	€
<b>LK 11010 HD</b>	€	□	□	□	●	€	€
<b>LK 11010 HD V</b>	€	□	□	□	●	€	€

# BASKETS INCLUDED

<b>GLASSWASHERS</b>	2 x glass baskets, 1 x saucer holder, 1 x cutlery holder
<b>DISHWASHERS</b>	1 x dish basket, 1 x glass basket, 1 x cutlery holder (LUX 85 EL PLUS + 1 C43)
<b>HOOD-TYPE DISHWASHERS</b>	2 x Dish baskets, 1 x Glass basket, 2 x Cutlery holders
<b>RACK-TYPE DISHWASHERS</b>	1 x dish basket, 1 x glass basket, 1 x cutlery basket 8 places, 1 x tray basket
<b>WAREWASHERS</b>	<p>KP 76 EL - KP 136 EL PLUS: 1 x S/S trays support, 1 x large mesh plastic basket, 1 x spatula holder (KP 76 EL + 1 S/S griddle)</p> <p>KP 86 EL PLUS: 1 x S/S griddle, 1 x S/S basket, 1 x trays support, 1 x S/S spatula holder</p> <p>KP 151 EL - KP 402 EL PLUS: 1 x S/S basket, 1 x S/S griddle, 1 x trays support, 1 x S/S spatula holder</p> <p>KP 202 EL PLUS - KP 302 EL PLUS - KP 402 EL PLUS: 1 x S/S basket, 1 x S/S trays support, 1 x S/S spatula holder</p>

<b>DELIVERY</b>	20 days for semi-automatic machines - 50 days for automatic machine
<b>PACKING</b>	Cardboard box (included in the price) The wooden cage's price is the equivalent of the 2% of the machine's net price - minimum amount charged is € (on the following models: RK, QK, TK, TL, VK, LK, LK-HD, K 7A, KM7, KM22, KM23, K 19, K 21, K 22, K 23, K 2ME, K5/20)
<b>SPARE PARTS</b>	For orders lower than net €, a € fee will be applied as management costs
<b>TERMS</b>	Ex-works
<b>WARRANTY ON OUR PARTS</b>	24 months from invoice date, subject to our technical department verification of the problem causes
<b>TRANSPORT</b>	The supply is carried out Ex works KROMO ALI GROUP Srl. The goods travel at the Purchaser's sole risk even when the carrier has been chosen and instructed by KROMO ALI GROUP Srl on behalf of the purchasing party
<b>OWNERSHIP RESERVATION</b>	The goods are the exclusive property of KROMO ALI GROUP Srl until the invoice is paid in full
<b>COURT OF JURISDICTION</b>	Contracts stipulated with KROMO ALI GROUP Srl are subject to Italian law. For any dispute that may arise from contracts with KROMO ALI GROUP Srl - including abroad contracts - the court of jurisdiction shall be that of Treviso
<b>USER MANUALS</b>	User Manuals are originally issued in a main E.U. language. When put into service, each machinery must be provided with an appropriate translation of the original Manual in the language(s) used in the Country where the appliance is installed accompanied by its original instructions, too. This translation is full care and responsibility of the Importer of the machinery in the end-user's region. In case of tunnel machines, the possibility to have our technician/s on site to assist in the assembly and start-up will be quoted separately.

Ensure adequate ventilation of the room according to the legislation in force in the country of installation and the relevant technical standards. For example, for European countries, please refer to the EN 16282-1 standard.

Continual improvements may supersede specifications.



\* The WRAS Approved Product logo is a certification marks which is owned by WRAS Ltd. - WRAS Approved Type AA - air gap

The certification brands do not refer to all products. Our documentation includes certified and non-certified products.

The information required by the Article 33 (1) of Regulation (EC) 1907/2006 (REACH) and the related SCIP notifications are available on our website.

For more information, please contact the manufacturer.





**KROMO ALI GROUP SRL**

Via Mestre, 3  
31033 Castelfranco Veneto (TV)  
T: +39 0423 734580  
E: [kromo@kromo-ali.com](mailto:kromo@kromo-ali.com)

**SERVICE:**

T: +39 0423 734593  
E: [service@kromo-ali.com](mailto:service@kromo-ali.com)

[www.kromo-ali.com](http://www.kromo-ali.com)

Edition 5.2024

an Ali Group Company



The Spirit of Excellence