



HOOD 130
MAXXI PLUS H+

HOOD-TYPE DISHWASHER

KROMO
YOUR SMART WASH

KROMO
YOUR SMART WASH

HOOD 130 MAXXI PLUS H+

HOOD-TYPE
DISHWASHER



We introduce the new versatile hood-type dishwasher, an innovative product designed to simplify the washing of objects of different sizes in an easy-to-use and efficient way. Equipped with a large basket of 600 x 500 mm, these machines can accommodate plates, glasses, pans and other objects of different sizes, ensuring impeccable results. Thanks to customizable washing programs, 2 Hygiene + cycles and an advanced

technology, this model guarantees perfect results in a short time, saving energy and water. A robust and resistant structure allows to last over time and offers high performance even after numerous uses. Whether you need to wash dishes in a restaurant, a bar or a canteen, the pass-through multifunction dishwasher is the ideal choice to ensure a more efficient management of your time.

HYGIENE+ SYSTEM

The HYGIENE+ models perform long cycles at high temperatures to fulfill high levels of hygiene, now more essential than ever for our health. These special programs comply with $A_0=30$ on the scale of thermo-disinfection according to the norm EN ISO 15883-1.

The HYGIENE+ models include 2 special cycles, a short one of 180 seconds and a longer one of 630 seconds, ensuring compliance with high levels of hygiene thanks to high temperatures and long cycles.



FEATURES

STANDARD

- Basket 600 x 500 mm
- Useful height 450 mm
- 6 wash cycles: 4 customizable cycles + 2 Hygiene + cycles
- Easy and intuitive electronic control panel
- Double skin insulated hood
- Deep tank
- Double tank filters, with dirt collection system and pump filter (improved system for a better filtration of the wash water)
- Self-cleaning vertical pump to avoid water stagnation: perfect hygiene
- Water consumption and working time control system
- Easy to access for maintenance
- Anti-drop roof panel
- Easily removable basket support
- Linear or corner layouts
- Self-cleaning cycle
- Peristaltic detergent and rinse aid dispensers included with dosage adjustable from the control panel
- The PLUS system grants a constant rinse temperature and pressure

OPTIONS

- ENERGY SAVING HR system: heat recovery and steam condenser
- DA: built-in water softener with automatic regeneration
- CONNECTIVITY remote control compliant with the HACCP norms
- Remote control panel available on request instead of the standard control panel
- Predisposition for connection to an external device of reverse osmosis

HOOD 130 MAXXI PLUS H+

HOOD-TYPE
DISHWASHER

CONNECTIVITY 4.0 & APP

WHEREVER YOU ARE...
YOUR DISHWASHER, JUST A CLICK AWAY

You will be constantly connected to the machine to monitor the work phases, review any eventual alarm and configure remotely the operating parameters according to your needs. Compliant with HACCP norms. Thanks to our brand new App, you will have access to connected machines and all commercial and technical documentation.

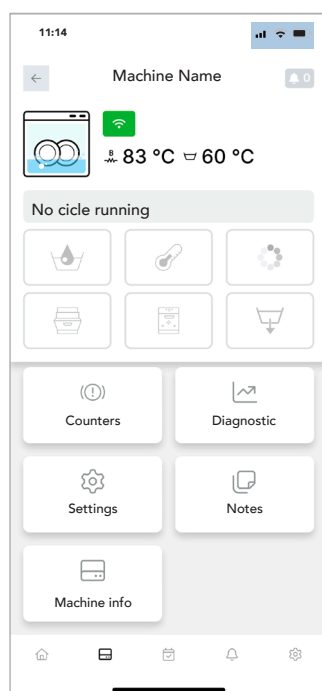
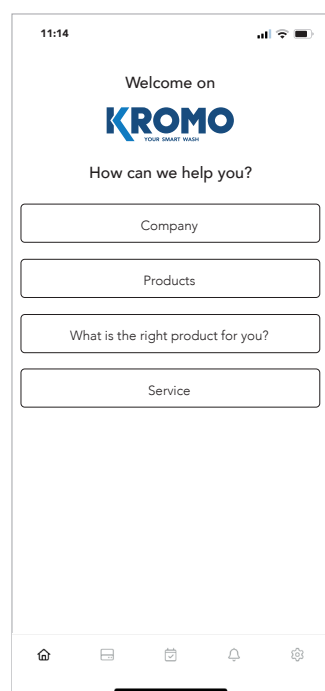

Time	Event	Description
11:15	Prewash 1	27.1
11:15	Wash 1	63
11:15	Rinse	35.9
11:14	Prewash 1	27.1
11:14	Wash 1	63.2
11:14	Rinse	36.1
11:13	Prewash 2	0
11:13	Rinse	0
11:13	Prewash 1	27
11:13	Wash 5	0
11:13	Wash 4	0
11:13	Wash 3	0
11:13	Wash 2	0

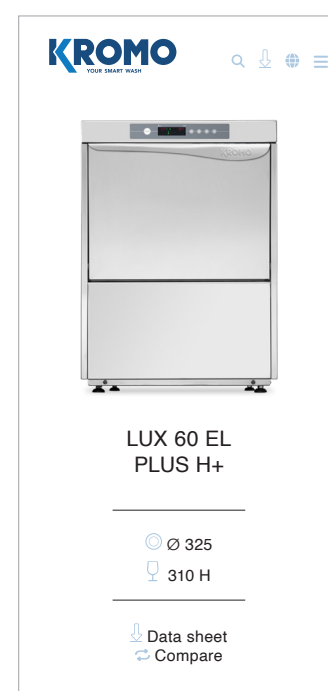

View all the working parameters and event records, working hours and any problem at any time.



In case of problem, the machine promptly alerts you. The technician can intervene remotely to solve the problem or anticipate the needed parts for an on-site intervention.



A daily activity report is available with all the events related to the dishwasher in a detailed spreadsheet with HACCP data.



Our Connectivity system is a revolutionary device limiting and facilitating the eventual intervention of a technician who can anticipate the necessary parts to be replaced, saving time and money.

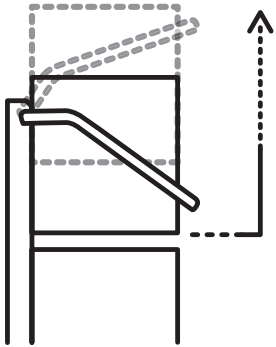

IMPROVED LIFT SYSTEM:

AUTOMATIC TWO-STEP HOOD LIFT AT THE END OF THE CYCLE

The hydraulic system has been replaced by an electric motor. Its simplicity limits maintenance and the formation of limescale. The latter, freeing up space, allows to add more options to the LIFT models such as the integrated automatic softener.

PLUS SYSTEM

GUARANTEED RINSE EVEN WITH LOW PRESSURE OF THE WATER INLET

We have developed an innovative rinsing system at constant temperature, consumption and water pressure, regardless of external conditions.

ATMOSPHERIC BOILER

The water temperature in the boiler remains constant at 85°C throughout the rinse, as the boiler refill only occurs once the rinse cycle is done.

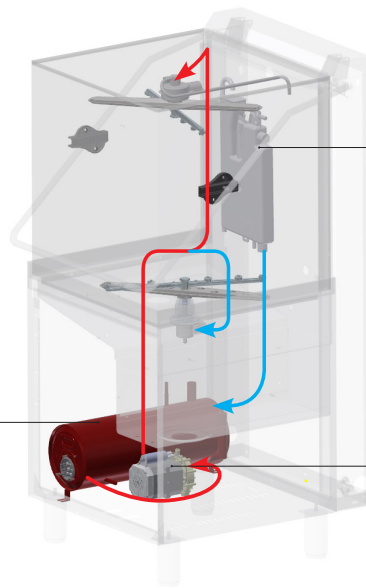

BREAK TANK

The Break Tank system prevents the heated water of the boiler to go back and mix with the fresh water supply.

RINSE PUMP

The water is sucked from the boiler through a rinse pump and is sent to the rinse nozzles. The correct pressure is ensured regardless of the water inlet pressure and temperature.

HR - ENERGY RECOVERY

The ENERGY RECOVERY system uses the heat produced by the machine to preheat the inlet cold water (8-15 °C). This is an immediate saving on energy costs. Additionally, an optimal temperature in the dishwashing area is achieved as the air is no more affected by steam and humidity.

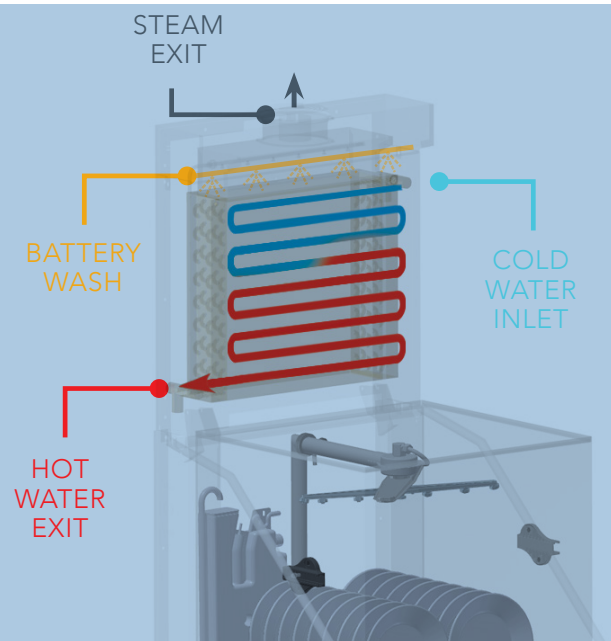





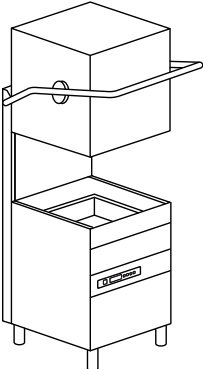
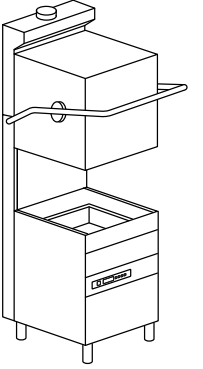

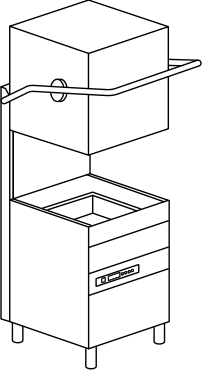

HOOD 130 MAXXI PLUS H+

HOOD-TYPE
DISHWASHER

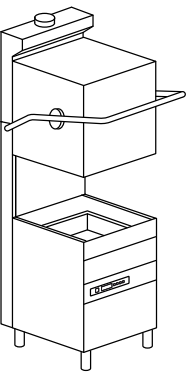
Model	Voltage	Capacity	Dimensions	Code
HOOD 130 MAXXI PLUS H+ ELECTRONIC 6 PROGRAMS				
 <div data-bbox="373 398 552 607" style="border: 1px solid black; padding: 5px;"> <p>RACK EQUIPMENT</p> <ul style="list-style-type: none"> 1 X C136 1 X C137 1 X C138 2 X 15060 </div> <div data-bbox="373 636 552 707"> <p>A₀=30 HYGIENE +</p> </div>	<p>400 V 3N ~ 50 Hz 10,5 kW</p>	<p>Ø 310</p> <p>310 < Ø < 410 *</p> <p>600x500</p>	<p>800x735x 1490/1961 H 120 kg</p> <p>GN 1/1</p> <p>530x325x25 H</p>	<p>HOOD 130 MAXXI PLUS H+</p> <p>HOOD 130 MAXXI PLUS DA H+</p>
HOOD 130 MAXXI HR PLUS H+ ELECTRONIC 6 PROGRAMS				
 <div data-bbox="373 855 552 1064" style="border: 1px solid black; padding: 5px;"> <p>RACK EQUIPMENT</p> <ul style="list-style-type: none"> 1 X C136 1 X C137 1 X C138 2 X 15060 </div> <div data-bbox="373 1093 552 1164"> <p>A₀=30 HYGIENE +</p> </div>	<p>400 V 3N ~ 50 Hz 10,5 kW</p>	<p>Ø 310</p> <p>310 < Ø < 410 *</p> <p>600x500</p>	<p>800x735x2162 H 150 kg</p> <p>GN 1/1</p> <p>530x325x25 H</p>	<p>HOOD 130 MAXXI HR PLUS H+</p> <p>HOOD 130 MAXXI HR PLUS DA H+</p>

* Usable plate diameter: from 310 mm to 410 mm

Model	Voltage	Capacity	Dimensions	Code
HOOD 130 MAXXI PLUS LIFT H+  <p>RACK EQUIPMENT 1 X C136 1 X C137 1 X C138 2 X 15060</p> <p>A₀=30 HYGIENE +</p>	ELECTRONIC 6 PROGRAMS 400 V 3N ~ 50 Hz 10,5 kW	 Ø 310  310 < Ø < 410 *  600x500	800x735x 1490/1961 H 120 kg  530x325x25 H	HOOD 130 MAXXI PLUS LIFT H+ HOOD 130 MAXXI PLUS LIFT DA H+
HOOD 130 MAXXI HR PLUS LIFT H+  <p>RACK EQUIPMENT 1 X C136 1 X C137 1 X C138 2 X 15060</p> <p>A₀=30 HYGIENE +</p>	ELECTRONIC 6 PROGRAMS 400 V 3N ~ 50 Hz 10,5 kW	 Ø 310  310 < Ø < 410 *  600x500	800x735x2162 H 150 kg  530x325x25 H	HOOD 130 MAXXI HR PLUS LIFT H+ HOOD 130 MAXXI HR PLUS LIFT DA H+

HOOD 130 MAXXI PLUS H+

HOOD-TYPE
DISHWASHER

OPTIONS

	RO	XP	PS	DDE					
Model	380-415 V 3N 50 Hz	220-240V 3 50 Hz	380-415 V 3 50 Hz	440 V 3 60 Hz	60 Hz	Osmosis Connection	Extra Power	Drain Pump	Detergent Dispenser
HOOD 130 MAXXI PLUS H+	●	□	€	€	€	□	€	€	●
HOOD 130 MAXXI PLUS DA H+	●	□	€	€	€	----	€	€	●
HOOD 130 MAXXI HR PLUS H+	●	□	€	€	€	□	€	€	●
HOOD 130 MAXXI HR PLUS DA H+	●	□	€	€	€	----	€	€	●
HOOD 130 MAXXI PLUS LIFT H+	●	□	€	€	€	□	€	€	●
HOOD 130 MAXXI PLUS LIFT DA H+	●	□	€	€	€	----	€	€	●
HOOD 130 MAXXI HR PLUS LIFT H+	●	□	€	€	€	□	€	€	●
HOOD 130 MAXXI HR PLUS LIFT DA H+	●	□	€	€	€	----	€	€	●

- Standard
- Upon request
- Not available
- DA** Built-in automatic water softener
- HR** Disposable in case of osmotic water supply, if the electrical conductivity is higher than 200 microsiemens
- PLUS** Rinse with constant temperature and stabilized consumption
- H+** 2 cycles of 630 and 180 seconds with high temperatures, reaching up to 70 °C for washing and 90°C for rinsing

Water supply 55 °C (not on HR version)

EAC label upon request

Model	DBE	BT	WRAS	DVGW	CONN.	PAP	ID	DF	FLOAT	CONTROL
	Peristaltic Rinse-Aid Disp.	Break tank	Wras	DVGW	Connectivity (HACCP)	Booster pump	Double Skin	Surface Filters Kit	Probes Lack det. and rinse aid	Substitute remote control panel
HOOD 130 MAXXI PLUS H+	●	●	€	€	€	●	●	●	€	€
HOOD 130 MAXXI PLUS DA H+	●	----	----	----	€	●	●	●	€	€
HOOD 130 MAXXI HR PLUS H+	●	●	€	----	€	●	●	●	€	€
HOOD 130 MAXXI HR PLUS DA H+	●	----	----	----	€	●	●	●	€	€
HOOD 130 MAXXI PLUS LIFT H+	●	●	€	€	€	●	●	●	€	€
HOOD 130 MAXXI PLUS LIFT DA H+	●	----	----	----	€	●	●	●	€	€
HOOD 130 MAXXI HR PLUS LIFT H+	●	●	€	----	€	●	●	●	€	€
HOOD 130 MAXXI HR PLUS LIFT DA H+	●	----	----	----	€	●	●	●	€	€

PS Not available with 380-415 V 3 50 Hz and 440 V 3 60 Hz

XP In case of cold water supply for rinse 8 °C 55 °C, and without any heat recovery, the extra power option is mandatory. + 3000 W with standard voltage only, for other voltages please contact us. In case of cold water supply for rinse 8-15 °C, We recommend the heat recovery option.

BT - WRAS - DVGW Booster pump included

DVGW Components prescribed by DVGW on request (check option compatibility with the manufacturer)

CONNECTIVITY Includes HACCP option. 10 year plan

HR Disponible in case of osmotic water supply, if the electrical conductivity is higher than 200 microsiemens

Option compatibility to be confirmed by the manufacturer after verification

HOOD 130 MAXXI PLUS H+

	Description	Capacity	Dimensions	Code	
	PLATE BASKET	Standard 22 plates Ø < 310 mm	600x500x115 H	C 136	
	LARGE MESH BASKET	Standard	600x500x115 H	C 137	
	TRAYS OR PLATES BASKET	Standard 12 trays up to 47 cm wide or for 10 GN1/1 (max depth 2,5 cm) or 11 plates 310 < Ø < 410 mm (max depth 2,5 cm)	600x500x115 H	C 138	
	SAUCER HOLDER	12 saucers	300x100x90 H	10728	
	CUTLERY BASKET	Standard (2 pcs)	Ø 120x120 H	15060	
	WATER SOFTENER	12 l	Ø 200x500 H	DEP 12	
	AUTOMATIC WATER SOFTENER	12 l (max 800 l)	315x510x685 H	DEP 12-AUT	
	OSMOSIS	230 V 50 Hz - 250 W 5° C - 30° C Flow rate 240 l/h Not suitable for machine with integra- ted water softener Special basket dota- tion	270x411x451 H 18 Kg	K OS240	
	SHELF	Only for exit	600x510	K 2ME *	
	TABLE		650x510x860 H	K 4/65 *	

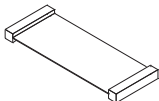
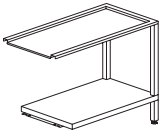
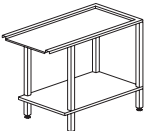
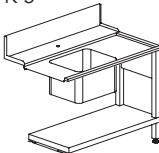
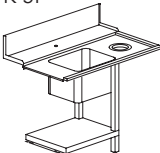
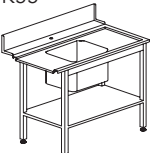
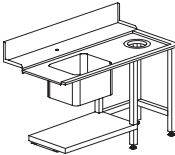
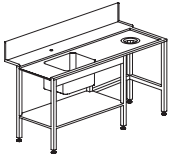
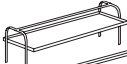
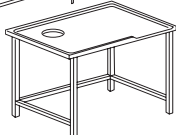
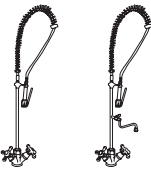
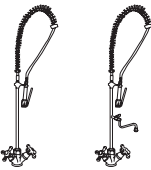
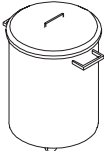
	Description	Capacity	Dimensions	Code	
	HOOD CONNECTION SHELF			KIT DUO	
K 4/70 B - K 4/120 B 	K 4B 	TABLE	700x590x860 H 1200x590x860 H 1200x590x860 H	K 4/70B * K 4/120B * K 4B *	
K 5 	K 5F 	K55 	Sink 500x400x270 H	1200x730x860 H 1200x730x860 H 1200x730x860 H	K 5 * K 5F * K 55 *
K 8 	K 8 E - K 9 	Sink 500x400x270 H	1500x730x860 H 1500x730x860 H 1800x730x860 H	K 8 * K 8E * K 9 *	
	SHELF		1515x620x660 H 2315x620x660 H	K 7M16 ** K 7M24 **	
	GRADING TABLE WITH RUBBER RING	Waste hole and special dimensions upon request	1600x1000x850 H 2400x1000x850 H	K 7A/1600 ** K 7A/2400 **	
	FLEXIBLE SHOWER complete with mixing group and lever tap, to be fixed to the wall		1000 H	K 1	
	FLEXIBLE SHOWER complete with mixing group and lever tap, to be fixed to the wall and intermediate tap		1000 H	K 1HR	
	STAINLESS STEEL WASTE BIN	Basic model With wheels With wheels and pedal board	Ø 400x570 H Ø 400x570 H Ø 400x570 H	K 7/1 K 7/2 K 7/3	

* Wooden cage +2% minimum + €
Special dimensions for tables upon request
Tables shown in right-to-left version

* Standard tables for linear installations. For tables positioned in front of the machine, a special table must be designed.
Do not hesitate to contact us for more information.



KROMO ALI GROUP SRL

Via Mestre, 3
31033 Castelfranco Veneto (TV)
T: +39 0423 734580
E: kromo@kromo-ali.com

SERVICE:

T: +39 0423 734593
E: service@kromo-ali.com

www.kromo-ali.com

Edition 10.2024

an Ali Group Company



The Spirit of Excellence