



CATALOGO
APRIL 2026

KROMO
YOUR SMART WASH

KROMO
YOUR SMART WASH

UNDER-COUNTER DISHWASHERS

BLUE	Robust and essential glass & dishwashers	2
AQUA	Glass & dishwashers with double-wall door	10
DUPLA	Double skin glass & dishwashers	20
LUX	High-tech double skin glass & dishwashers	28
BOTTLE COMBI LUX PLUS	High-tech double skin bottlewasher	38
PREMIUM	Glass and dishwashers with clean water technology	48

HOOD-TYPE DISHWASHERS

HOOD 70	Robust and essential hood-type dishwashers	58
HOOD 80 - 110	Single skin hood-type dishwashers	66
HOOD 110 I	Insulated hood-type dishwashers	74
HOOD 130 LUX	Latest generation hood-type dishwashers	82
HOOD 130 MAXXI PLUS H+	Multipurpose hood-type dishwasher	92
HOOD 140 PREMIUM	Connected hood-type dishwashers with clean water technology	102



STOCK & WASH DISHWASHERS

WASH & STORE	Stock & Wash dishwashers	112
--------------	--------------------------	-----

RACK-TYPE DISHWASHERS

RK COMPACT	Compact rack-type dishwashers with simple rinse	120
RK UP	Rack-type dishwashers with double rinse	128
RK LUX	Rack-type dishwashers with reinforced double rinse	138
RK PREMIUM	Rack-type dishwashers with 3R+ reinforced triple rinse	150

FLIGHT-TYPE DISHWASHERS

 QK LUX	Flight-type dishwashers with reinforced double rinse	162
 QK PREMIUM	Flight-type dishwashers with 3R+ reinforced triple rinse	178

TUNNEL TRAY WASHER & TRANSPORTATION SYSTEMS

TK	Tunnel traywasher with dryer	194
POLICORDA	Transportation systems	198

WAREWASHERS

POT	Warewashers	200
AQUAFORCE	Combi high pressure utensil and dishwasher	216

GRANULE WAREWASHER

GRANULE	Granule warewashers	226
---------	---------------------	-----

PULL-THROUGH CRATE WASHERS

VK - VK LUX	Pull-through crate washers	232
-------------	----------------------------	-----

CONVEYOR CRATE WASHERS

LK - LK-HD	Conveyor crate washers	242
------------	------------------------	-----

BASKETS INCLUDED - TERMS

Standard supplied baskets - General sales conditions	256 - 257
--	-----------

SERVICE

Service portal	258
----------------	-----

BLUE

ROBUST AND ESSENTIAL
GLASS & DISHWASHERS



You asked and we listened! We are thrilled to announce our brand new range: BLUE. These robust and essential glass and dishwashers simply make sense. Nothing superfluous: solid S/S body

with double wall-door, sloped tank, innovative and light arms, controlled temperatures and an optional detergent dispenser and drain pump. Wash, rinse, restart. It is really that simple.











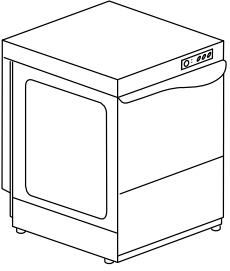



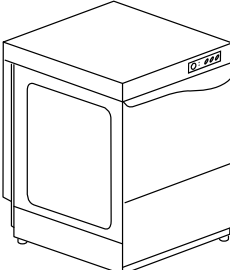



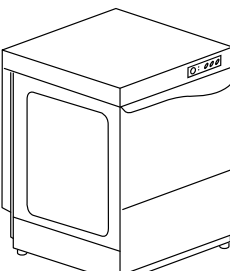





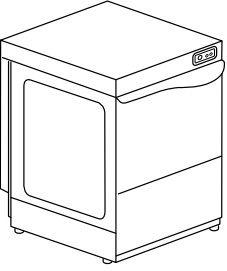

ELECTRONIC VERSION

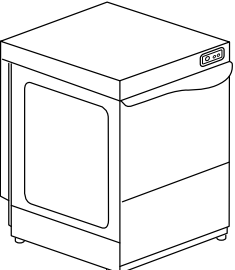
The intuitive LED control panel of the BLUE L models will display if the correct temperature of both tank and boiler have been reached. You can choose among 3 different wash programs to perfectly tailor the performances of the machine to the crockery that needs to be cleaned.

FEATURES

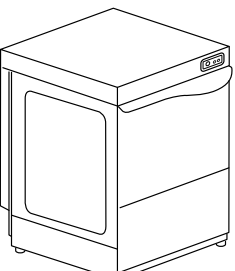
- Solid structure in AISI 304 stainless steel
- Sound and heat proof double-skin door
- Door with anti-shock system
- Sloped tank with screwed basket rails
- Overflow and drain pipes integrated system, for the triple protection of the washing pump
- Non-drip roof to safeguard the hygiene of the freshly washed dishes
- 1 wash cycle on electromechanical versions
- 3 wash cycles on electronic versions
- Innovative system of coupled wash and rinse arms in polypropylene and fiber of glass (BLUE 50 / BLUE 50 L)
- Light wash and rinse arms, granting the best efficiency also when the water pressure is weaker
- Easy to remove nozzles, to help with daily cleaning operations
- Back flow prevention valve
- Thermostop system: the rinse starts only when the water in boiler reaches 85 °C
- Standard rinse-aid dispenser
- Glasswashers also available with round basket (BLUE 35 / BLUE 40)
- Self-cleaning cycle on the electronic versions

Model		Voltage	Capacity	Dimensions	Code
BLUE 35 1 PROGRAM					
	<p>RACK EQUIPMENT</p> <ul style="list-style-type: none"> 2 X 10730 1 X 10728 1 X 15060 	230 V ~ 50 Hz 2,59 kW	 195 H  350x350	400x495x585 H 28 kg	BLUE 35
BLUE 40 1 PROGRAM					
	<p>RACK EQUIPMENT</p> <ul style="list-style-type: none"> 2 X C121 1 X 10728 1 X 15060 	230 V ~ 50 Hz 2,59 kW 2,65 kW (LS)	 305 H  Ø 295 (LS)  400x400	450x535x700 H 37 kg	BLUE 40 BLUE 40 LS
BLUE 50 1 PROGRAM					
	<p>RACK EQUIPMENT</p> <ul style="list-style-type: none"> 1 X C40 1 X C44 1 X 15060 	230 V ~ 50 Hz 3,2 kW	 320 H  Ø 345  500x500	590x600x850 H 57 kg	BLUE 50

Model		Voltage	Capacity	Dimensions	Code
BLUE 35 L 3 PROGRAMS					
	<p>RACK EQUIPMENT</p> <ul style="list-style-type: none"> 2 X 10730 1 X 10728 1 X 15060 	230 V ~ 50 Hz 2,59 kW	 195 H  350x350	400x495x595 H 28 kg	BLUE 35 L
BLUE 40 L 3 PROGRAMS					
	<p>RACK EQUIPMENT</p> <ul style="list-style-type: none"> 2 X C121 1 X 10728 1 X 15060 	230 V ~ 50 Hz 2,59 kW 2,65 kW (LS)	 305 H  Ø 295 (LS)  400x400	450x535x710 H 37 kg	BLUE 40 L BLUE 40 LS L
BLUE 50 L 3 PROGRAMS					
	<p>RACK EQUIPMENT</p> <ul style="list-style-type: none"> 1 X C40 1 X C44 1 X 15060 	230 V ~ 50 Hz 3,2 kW	 320 H  Ø 345  500x500	590x600x850 H 57 kg	BLUE 50 L





OPTIONS

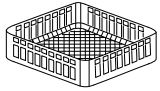

		PS	DDE	DB	CR	TS
Model	220-240 V 50 Hz	Drain pump	Detergent dispenser	Rinse-aid dispenser	Round basket	thermostop system
BLUE 35	●	€	€	●	€	●
BLUE 40	●	€	€	●	€	●
BLUE 40 LS	●	€	€	●	€	●
BLUE 50	●	€	€	●	----	●
BLUE 35 L	●	€	€	●	€	●
BLUE 40 L	●	€	€	●	€	●
BLUE 40 LS L	●	€	€	●	€	●
BLUE 50 L	●	€	€	●	----	●

- LS** Upper wash
- L** LED electronic
- Standard
- Not available

Water supply 55 °C. Water hardness min 2°f - max 8°f (if higher, an external water softener is required).

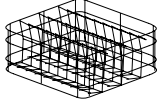
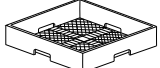
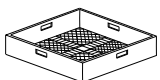
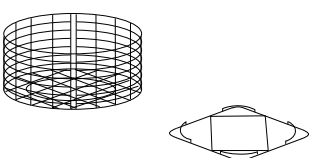
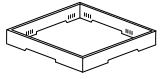
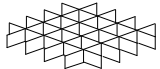
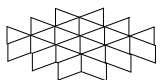
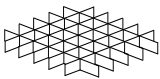
EAC label upon request

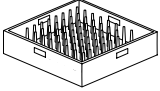
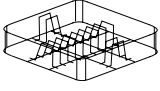
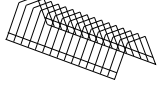
	Description	Capacity	Dimensions	Code
	GLASS BASKET		350x350x110 H	10730
			400x400x135 H	C 121
	SLOPED GLASS BASKET	Ø 100 max	500x500x200 H	C 26
	REUSABLE CUP BASKET	5x5 Glass 30 < Ø < 90 mm H max 185 mm	500x500x235 H	C 135 
	SLOPED GLASS BASKET		Ø 90 max	400x400x185 H C 123
			Ø 120 max	400x400x160 H C 79
	NARROW MESH CUTLERY BASKET		500x500x106 H	C 41
	LARGE MESH BASKET	For glasses	500x500x105 H	C 44
	ROUND GLASS BASKET	Basket	Ø 360x160 H	C 144
		Basket	Ø 390x170 H	C 145
	ROUND BASKET SUPPORT	Support	350x350	C 141
		Support	400x400	C 143
	HOLDER FOR GLASS SUPPORT	For glass support (C112-C113-C114)	500x500x50 H	C 111
	GLASS SUPPORT	5x5 Glass Ø 87 mm (C111)	500x500x50 H	C 112
	GLASS SUPPORT	4x4 Glass Ø 110 mm (C111)	500x500x50 H	C 113
	GLASS SUPPORT	6x6 vGlass Ø 72 mm (C111)	500x500x50 H	C 114

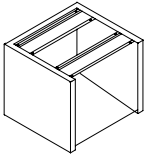
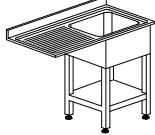
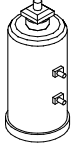
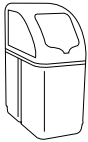
	Description	Capacity	Dimensions	Code	
	PLATE BASKET	18 plates	500x500x105 H	C 40	
	PLATE BASKET	12 plates	400x400x120 H	C 31	
	SAUCER HOLDER	14 saucers	300x100x90 H	10728	
	CUTLERY BASKET		110x110x120 H	15060	
	SUPPORT	Stainless steel stand for undercounter 500 x 500	592x535x500 H	999900517	
	SINK UNIT FOR UNDERCOUNTER MODELS	Sink 500x400x300 H	1200x700x850 H	K 5/20 *	
	WATER SOFTENER	12 l	Ø 200x500 H	DEP 12	
	AUTOMATIC WATER SOFTENER	12 l (max 800 l)	315x510x685 H	DEP 12-AUT	

* Wooden cage +2% minimum + €
Special dimensions for tables upon request
Tables shown in right-to-left version

new



The glass and dishwashers of the AQUA series are ideal for bars, pubs, restaurants and hotels. These under-counter beautifully designed machines with a newly re-designed control panel, feature a wide loading capacity granting the highest performance at a reasonable price. According to the user's needs the machine can be

customized thanks to many optional features such as water softener, detergent dispenser and drain pump. Building on these strengths, we are proud to introduce AQUA 50 N. This new model stands out for its reduced height compared to the standard version, while maintaining all the features that have made its "sister" model so successful over the years.











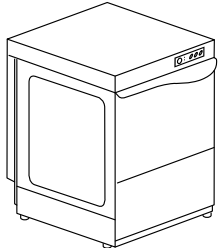

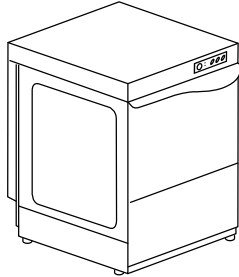



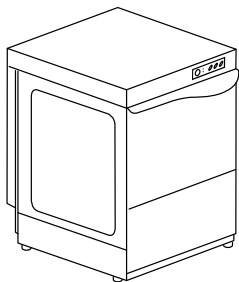





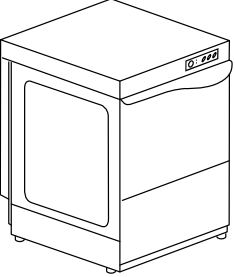

ELECTRONIC VERSION

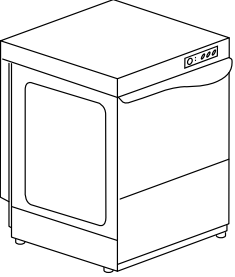



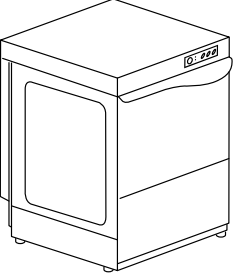





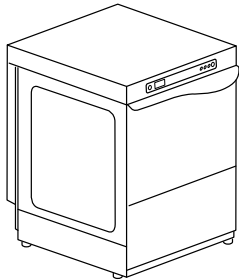



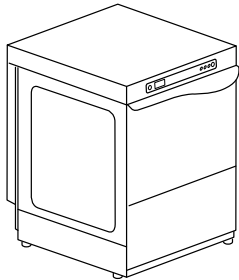

An electronic control panel is available for AQUA T models. The LED panel displays the temperatures of both tank and boiler, the wash cycle and status and main alarm codes for malfunctions. You can now choose among four different washing programs to perfectly tailor the performances of the machine to the crockery that needs to be cleaned. The soft start function grants extra protection for fragile objects.

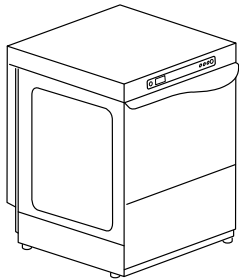
FEATURES

- AISI 304 structure
- Sound and heat proof double-skin door
- Door with anti-shock system
- Deep-drawn and inclined tank for a perfect total drain
- Overflow and drain pipes integrated system, for a triple protection of the wash pump
- Non-drip roof to safeguard the hygiene of the freshly washed dishes
- Light wash and rinse arms, granting the best efficiency also when the water pressure is weaker
- Easy to remove nozzles, to help with daily cleaning operations
- Back flow prevention valve
- Standard rinse-aid dispenser (peristaltic version on demand)
- Thermostop system: the rinse starts only when the water in boiler reaches 85 °C
- CE certified components
- Electronic version with four preset washing programs
- Built-in water softener recommended for water > 8°f; max 35°f
- Glasswashers available also with round basket (AQUA 35 / AQUA 37 / AQUA 40)
- Innovative system of coupled wash and rinse arms in polypropylene and fiber of glass (all AQUA 50 and AQUA 80 T models)
- Self-cleaning cycle on the TOUCH versions
- Soft Start wash pump on the TOUCH versions
- Additional upper surface filter (all AQUA 50 and AQUA 80 T models)

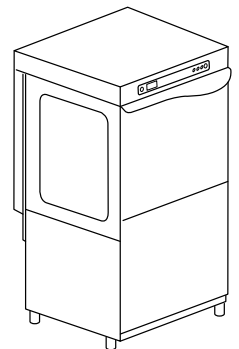
Model		Voltage	Capacity	Dimensions	Code
AQUA 35 1 PROGRAM					
	<p>RACK EQUIPMENT</p> <ul style="list-style-type: none"> 2 X 10730 1 X 10728 1 X 15060 	230 V ~ 50 Hz 2,6 kW	 195 H  350x350	400x495x585 H 28 kg	<p>AQUA 35</p> <p>AQUA 35 D</p>
AQUA 37 1 PROGRAM					
	<p>RACK EQUIPMENT</p> <ul style="list-style-type: none"> 2 X C10 1 X 10728 1 X 15060 	230 V ~ 50 Hz 2,6 kW 2,8 kW (LS)	 275 H  Ø 280 LS  370x370	420x490x650 H 30 kg	<p>AQUA 37</p> <p>AQUA 37 D</p> <p>AQUA 37 LS</p> <p>AQUA 37 LS D</p>
AQUA 40 1 PROGRAM					
	<p>RACK EQUIPMENT</p> <ul style="list-style-type: none"> 2 X C121 1 X 10728 1 X 15060 	230 V ~ 50 Hz 3,2 kW	 305 H  Ø 295 LS  400x400	450x535x700 H 37 kg	<p>AQUA 40</p> <p>AQUA 40 D</p> <p>AQUA 40 LS</p> <p>AQUA 40 LS D</p>

Model		Voltage	Capacity	Dimensions	Code
AQUA 50 N LOWERED HEIGHT					
	 RACK EQUIPMENT 1 X C40 1 X C44 1 X 15060	400 V 3N ~ 50 Hz 5,2 kW	 320 H	590x600x820 H 56 kg	AQUA 50 N
			 Ø 345  500x500		
AQUA 50 MONO 15 AMP MONOPHASE - 1 PROGRAM					
	RACK EQUIPMENT 1 X C40 1 X C44 1 X 15060	230 V ~ 50 Hz 3,5 kW	 320 H	590x600x850 H 57 kg	AQUA 50 MONO
			 Ø 345  500x500		
AQUA 50 2 PROGRAMS					
	RACK EQUIPMENT 1 X C40 1 X C44 1 X 15060	400 V 3N ~ 50 Hz 5,2 kW	 320 H	590x600x850 H 57 kg	AQUA 50
			 Ø 345  500x500	590x600x850 H 57 kg Surface filters	AQUA 50 D

Model		Voltage	Capacity	Dimensions	Code
AQUA 40 T ELECTRONIC 4 PROGRAMS					
	<p>RACK EQUIPMENT</p> <ul style="list-style-type: none"> 2 X C121 1 X 10728 1 X 15060 	230 V ~ 50 Hz 3,2 kW	 305 H  Ø 295 LS  400x400	450x535x700 H 37 kg	<p>AQUA 40 T</p> <p>AQUA 40 T DA</p> <p>AQUA 40 T LS</p> <p>AQUA 40 T LS DA</p>
AQUA 50 N T					
	<p><i>New</i></p> <p>RACK EQUIPMENT</p> <ul style="list-style-type: none"> 1 X C40 1 X C44 1 X 15060 	400 V 3N ~ 50 Hz 5,2 kW	 320 H  Ø 345  500x500	590x600x820 H 56 kg	<p>AQUA 50 N T</p> <p>Surface filters</p>
AQUA 50 T ELECTRONIC 4 PROGRAMS					
	<p>RACK EQUIPMENT</p> <ul style="list-style-type: none"> 1 X C40 1 X C44 1 X 15060 	400 V 3N ~ 50 Hz 5,2 kW	 320 H  Ø 345  500x500	590x600x850 H 57 kg	<p>AQUA 50 T</p> <p>AQUA 50 T DA</p> <p>Surface filters</p>
AQUA 80 T ELECTRONIC 4 PROGRAMS					
	<p>RACK EQUIPMENT</p> <ul style="list-style-type: none"> 1 X C40 1 X C44 1 X 15060 	400 V 3N ~ 50 Hz 6,9 kW	 355 H  Ø 380  500x500	590x600x1290 H 69 kg	<p>AQUA 80 T</p> <p>AQUA 80 T DA</p> <p>Surface filters</p>

OPTIONS

Model	Voltage			60 Hz	Electronic timer	XP	PS	DDE	ST	DB
	220-250 V 50 Hz	380-415 V 3N 50 Hz	220-250 V 3 50 Hz							
AQUA 35	●	----	----	€	●	----	€	€ **	----	●
AQUA 35 D	●	----	----	€	●	----	€	€ **	----	●
AQUA 37	●	----	----	€	●	----	€	€ **	----	●
AQUA 37 D	●	----	----	€	●	----	€	€ **	----	●
AQUA 37 LS	●	----	----	€	●	----	€	€ **	----	●
AQUA 37 LS D	●	----	----	€	●	----	€	€ **	----	●
AQUA 40	●	----	----	€	●	€	€	€	----	●
AQUA 40 D	●	----	----	€	●	€	€	€ **	----	●
AQUA 40 LS	●	----	----	€	●	€	€	€	----	●
AQUA 40 LS D	●	----	----	€	●	€	€	€ **	----	●
AQUA 50 N	□	●	□	€	●	€	€	€	----	●
AQUA 50 MONO	●	----	----	€	●	----	€	€	----	●
AQUA 50	□	●	□	€	●	€	€	€	----	●
AQUA 50 D	□	●	□	€	●	€	€	€	----	●
AQUA 40 T	●	----	----	€	●	----	€	€	●	●
AQUA 40 T DA	●	----	----	€	●	----	€	€ **	●	●
AQUA 40 T LS	●	----	----	€	●	----	€	€	●	●
AQUA 40 T LS DA	●	----	----	€	●	----	€	€ **	●	●
AQUA 50 N T	□	●	□	€	●	€	€	€	●	●
AQUA 50 T	□	●	□	€	●	€	€	€	●	●
AQUA 50 T DA	□	●	□	€	●	€	€	€	●	●
AQUA 80 T	€	●	□	€	●	----	€	€	●	●
AQUA 80 T DA	€	●	□	€	●	----	€	€	●	●

D Built-in water softener

DA Built-in water softener with automatic regeneration

LS Upper wash

T LED Electronic (Soft Touch)

● Standard

---- Not available

□ Upon request





** For reasons of space, please choose between DBE DDE.

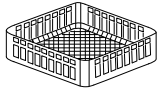

* Construction according to UL-NSF standards upon request

XP Recommended with water 8-55 °C. AQUA 50 only with standard voltage. For other voltages please contact us

	DBE	FS	PS+FS	CR	PS+DDE +FS	TS	BT	WRAS	PAP	DF
Model	Peristaltic rinse-aid disp.	Cold rinse	PS + FS	Round basket	PS + DDE + FS	Thermostop system	Break tank	WRAS	Booster pump	Surface filters
AQUA 35	€ **	€	€	€	€	●	----	----	----	----
AQUA 35 D	€ **	----	----	€	----	●	----	----	----	----
AQUA 37	€ **	€	€	€	€	●	----	----	----	----
AQUA 37 D	€ **	----	----	€	----	●	----	----	----	----
AQUA 37 LS	€ **	€	€	€	€	●	----	----	----	----
AQUA 37 LS D	€ **	----	----	€	----	●	----	----	----	----
AQUA 40	€	€	€	€	€	●	----	----	----	----
AQUA 40 D	€ **	----	----	€	----	●	----	----	----	----
AQUA 40 LS	€	€	€	€	€	●	----	----	----	----
AQUA 40 LS D	€ **	----	----	€	----	●	----	----	----	----
AQUA 50 N	€	€	€	----	€	●	----	€	----	€
AQUA 50 MONO	€	----	----	----	----	●	----	----	----	€
AQUA 50*	€	€	€	----	€	●	€	€	€	€
AQUA 50 D	€	€	----	----	----	●	----	----	----	€
AQUA 40 T	€	€	€	€	€	●	----	----	----	----
AQUA 40 T DA	€ **	€	€	€	----	●	----	----	----	----
AQUA 40 T LS	€	€	€	€	€	●	----	----	----	----
AQUA 40 T LS DA	€ **	€	€	€	€	●	----	----	----	----
AQUA 50 N T	€	€	€	----	€	●	----	€	----	€
AQUA 50 T	€	€	€	----	€	●	€	€	€	€
AQUA 50 T DA	€	€	€	----	€	●	----	----	----	€
AQUA 80 T	€	€	€	----	€	●	€	€	€	€
AQUA 80 T DA	€	€	----	----	----	●	----	----	€	€

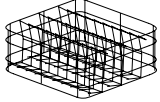
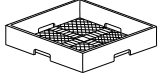
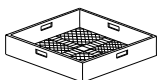
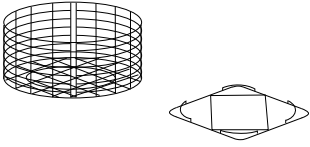
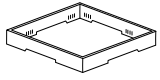
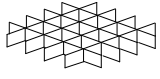
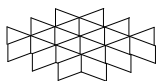
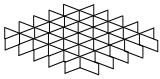
- SOFT START** Progressive start of the wash pump
- BT - WRAS** Booster pump included
- 220-250 V 50 HZ** For AQUA 50 max boiler heating element 4500 W
- Option compatibility to be confirmed by the manufacturer after verification
- Water supply 55 °C
- EAC label upon request

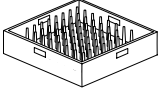
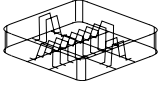
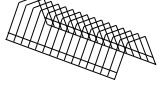
	Description	Capacity	Dimensions	Code
	GLASS BASKET		350x350x110 H 400x400x135 H 370x370x130 H	10730 C 121 C 10
	SLOPED GLASS BASKET	Ø 85 max Ø 100 max	370x370x210 H 500x500x200 H	C 39 C 26
	REUSABLE CUP BASKET	5x5 Glass 30 < Ø < 90 mm H max 185 mm	500x500x235 H	C 135 
	SLOPED GLASS BASKET	Ø 90 max Ø 120 max	400x400x185 H 400x400x160 H	C 123 C 79
	NARROW MESH CUTLERY BASKET		500x500x106 H	C 41
	LARGE MESH BASKET	For glasses	500x500x105 H	C 44
	ROUND GLASS BASKET	Basket	Ø 360x160 H	C 144
		Basket	Ø 390x170 H	C 145
	ROUND BASKET SUPPORT	Support	350x350	C 141
		Support	370x370	C 142
		Support	400x400	C 143
	HOLDER FOR GLASS SUPPORT	For glass support (C112-C113-C114)	500x500x50 H	C 111
	GLASS SUPPORT	5x5 Glass Ø 87 mm (C111)	500x500x50 H	C 112
	GLASS SUPPORT	4x4 Glass Ø 110 mm (C111)	500x500x50 H	C 113
	GLASS SUPPORT	6x6 Glass Ø 72 mm (C111)	500x500x50 H	C 114

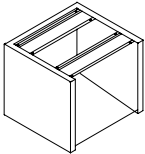
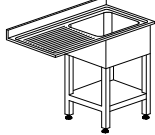
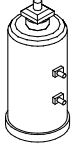
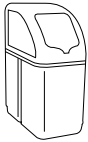
	Description	Capacity	Dimensions	Code	
	PLATE BASKET	18 plates	500x500x105 H	C 40	
	PLATE BASKET	10 plates	370x370x100 H	C 03	
		12 plates	400x400x120 H	C 31	
	SAUCER HOLDER	14 saucers	300x100x90 H	10728	
	CUTLERY BASKET		110x110x120 H	15060	
	SUPPORT	Stainless steel stand for undercounter 500 x 500	592x535x500 H	999900517	
	SINK UNIT FOR UNDERCOUNTER MODELS	Sink 500x400x300 H	1200x700x850 H	K 5/20 *	
	WATER SOFTENER	12 l	Ø 200x500 H	DEP 12	
	AUTOMATIC WATER SOFTENER	12 l (max 800 l)	315x510x685 H	DEP 12-AUT	

* Wooden cage +2% minimum + €
Special dimensions for tables upon request
Tables shown in right-to-left version



The DUPLA range of double-skinned undercounter dishwashers is designed to ensure reliability, quiet operation and maximum hygiene even in the most demanding professional environments. Available in electronic and electromechanical versions, these machines also offer various options and configurations to customize them to your needs. This

comprehensive range expands with a new Thermolabel model, designed to ensure efficiency and consistently excellent washing results. It's the perfect choice for professional kitchens that require consistent, uncompromising performance.



ELECTRONIC VERSION









A new electronic control panel is now available for DUPLA T models. The new LED panel will display the temperatures of both tank and boiler, the wash cycle and status and main alarm codes for malfunctions. You can now choose among 4 different washing programs to perfectly tailor the performances of the machine to the crockery that needs to be cleaned. The soft start function grants extra protection for fragile objects

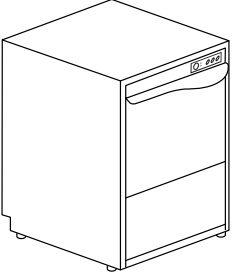

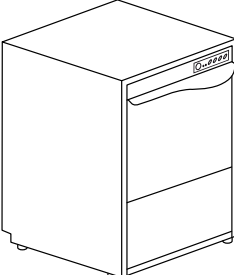

THERMOLABEL



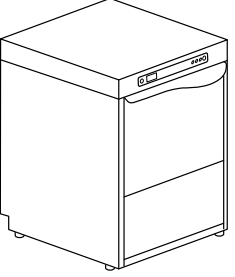

When hygiene needs to be proven, promises aren't enough: documented results are essential. The DUPLA 50 T meets the requirements of the Thermolabel test, confirming the washing cycle's actual disinfection effectiveness. The Thermolabel test system guarantees a temperature of 71°C reached and maintained on the surface of the plates, thus delivering excellent hygiene results and guaranteed compliance with HACCP standards. Powerful, reliable and designed for demanding environments, it is the ideal choice for professional kitchens in hotel groups, airline catering, and commercial and institutional food service that cannot afford downtime

FEATURES

- Double walled AISI 304 structure
- Pressed basket supports
- Upper wash arms even on the glasswashers (DUPLA 40 LS, DUPLA 40 LS T)
- Double skin door with anti-shock system
- Deep-drawn and sloped tank for a perfect total drain
- Overflow and drain pipes integrated system, for a triple protection of the washing pump
- Non-drip roof of safeguard the hygiene of the freshly washed dishes
- Light rinse arms, granting the best efficiency also even of weak pressure in the water mains
- Standard upper wash
- S/S wash arms (DUPLA 50 , DUPLA 50 T)
- Easy to remove nozzles, to help with daily cleaning operations
- Back flow prevention valve
- Rinse-aid dispenser (peristaltic version on demand)
- Thermostop system: the rinse starts only when the water in boiler reaches 85 °C
- CE Certified components
- Electronic version with four preset washing programs
- D: built-in water softener recommended for water > 8°f; max 35°f
- Glasswashers available also with round basket
- Self-cleaning cycle on the TOUCH versions
- Soft Start wash pump on the TOUCH versions
- Additional upper surface filter (on demand only for DUPLA 50, DUPLA 50 T, DUPLA 50 TT)

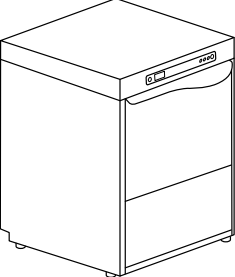



Model	Voltage	Capacity	Dimensions	Code
DUPLA 40 LS UPPER WASH - 1 PROGRAM				
	<p>RACK EQUIPMENT 2 X C121 1 X 10728 1 X 15060</p> 	<p>230 V ~ 50 Hz 3,2 kW</p>	<p>305 H</p>  <p>Ø 295</p>  <p>400x400</p>	<p>DUPLA 40 LS</p>
				<p>DUPLA 40 LS D</p>
DUPLA 50 2 PROGRAMS				
	<p>RACK EQUIPMENT 1 X C40 1 X C44 1 X 15060</p> 	<p>230 V ~ 50 Hz 3,45 kW</p>	<p>310 H</p>  <p>Ø 325</p>  <p>500x500</p>	<p>DUPLA 50 MONO</p>
		<p>400 V 3N~ 50 Hz 5,2 kW</p>		<p>595x610x845 H 61 kg</p>

Model	Voltage	Capacity	Dimensions	Code
DUPLA 40 LS T UPPER WASH - ELECTRONIC 4 PROGRAMS				
 <div style="border: 1px solid black; padding: 5px; margin-top: 10px;"> <p>RACK EQUIPMENT</p> <ul style="list-style-type: none"> 2 X C121 1 X 10728 1 X 15060 </div>	230 V ~ 50 Hz 3,2 kW	 305 H  Ø 295  400x400	460x545x715 H 38 kg	<p>DUPLA 40 LS T</p> <p>DUPLA 40 LS T DA</p>

Model	Voltage	Capacity	Dimensions	Code
DUPLA 50 T ELECTRONIC 4 PROGRAMS				
 <div style="border: 1px solid black; padding: 5px; margin-top: 10px;"> <p>RACK EQUIPMENT</p> <ul style="list-style-type: none"> 1 X C40 1 X C44 1 X 15060 </div>	400 V 3N ~ 50 Hz 5,2 kW	 310 H  Ø 325  500x500	595x610x845 H 61 kg	<p>DUPLA 50 T</p> <p>DUPLA 50 T DA</p> <p>Surface filters</p>

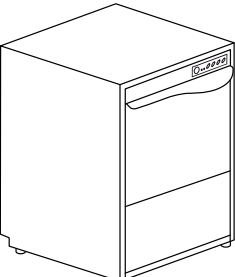
DUPLA 50 TT

 THERMOLABEL DOUBLE SKIN
GLASS & DISHWASHERS

Model	Voltage	Capacity	Dimensions	Code
DUPLA 50 TT ELECTRONIC 4 PROGRAMS				
 <div style="border: 1px solid black; padding: 5px; margin-top: 10px;"> <p>RACK EQUIPMENT</p> <ul style="list-style-type: none"> 1 X C40 1 X C44 1 X 15060 </div>	400 V 3N ~ 50 Hz 5,2 kW	 310 H  Ø 325  500x500	595x610x845 H 61 kg	<p>DUPLA 50 TT</p> <p>DUPLA 50 TT DA</p> <p>Surface filters</p>

OPTIONS

	XP	PS	DDE	DB	ST	DF					
Model	220-240 V 50 Hz	380-415 V 3N 50 Hz	220-240 V 3 50 Hz	60 Hz	Electronic timer	Extra power	Drain pump	Detergent dispenser	Rinse-Aid dispenser	Soft start	Surface filters
DUPLA 40 LS	●	□	□	€	●	€	€	€	●	----	----
DUPLA 40 LS D	●	□	□	€	●	€	€	€	●	----	----
DUPLA 50 MONO	●	----	----	€	●	----	€	€	●	----	€
DUPLA 50 MONO D	●	----	----	€	●	----	€	€	●	----	€
DUPLA 50	□	●	□	€	●	€	€	€	●	----	€
DUPLA 50 D	□	●	□	€	●	€	€	€	●	----	€
DUPLA 40 LS T	●	----	----	€	●	----	€	€	●	●	----
DUPLA 40 LS T DA	●	----	----	€	●	----	€	€	●	●	----
DUPLA 50 T	□	●	□	€	●	€	€	€	●	●	€
DUPLA 50 T DA	□	●	□	€	●	€	€	€	●	●	€
DUPLA 50 TT	□	●	□	€	●	€	€	€	●	●	€
DUPLA 50 TT DA	□	●	□	€	●	€	€	€	●	●	€

LS Upper wash

D Built-in water softener

DA Built-in water softener with automatic regeneration

 **THERMOLABEL:** Machine that meets the Thermolabel test requirements, confirming the wash cycle's effective sanitization performance. The Thermolabel is a testing system that ensures a temperature of 71°C is reached and maintained on the plate surface, ensuring excellent hygiene results and guaranteed compliance with HACCP standards.

T LED Electronic (Soft Touch)

● Standard

---- Not available

□ Upon request





** For reasons of space, please choose between DBE DDE.

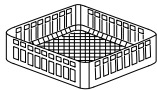

* Construction according to UL-NSF standards upon request

XP Recommended with water 8-55 °C. AQUA 50 only with standard voltage.
For other voltages please contact us

	DBE	CR	FS	PS+FS	PS+DDE +FS	TS	BT	WRAS	PAP
Model	Peristaltic rinse-aid disp.	Round basket	Cold rinse	PS + FS	PS + DDE + FS	Thermostop system	Break tank	WRAS	Booster pump
DUPLA 40 LS	€	€	€	€	€	●	----	----	----
DUPLA 40 LS D	€	€	----	----	----	●	----	----	----
DUPLA 50 MONO	€	----	€	€	€	●	€	€	€
DUPLA 50 MONO D	€	----	----	----	----	●	----	----	----
DUPLA 50	€	----	€	€	€	●	€	€	€
DUPLA 50 D	€	----	----	----	----	●	----	----	€
DUPLA 40 LS T	€	€	€	€	€	●	----	----	----
DUPLA 40 LS T DA	€	€	€	€	€	●	----	----	----
DUPLA 50 T	€	----	€	€	€	●	€	€	€
DUPLA 50 T DA	€	----	€	€	€	●	----	----	----
DUPLA 50 TT	€	----	€	€	€	●	€	€	€
DUPLA 50 TT DA	€	----	€	€	€	●	----	----	----

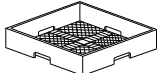
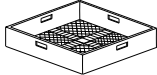
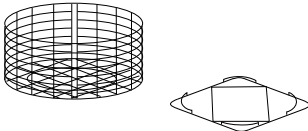
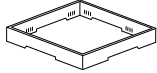
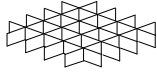
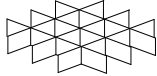
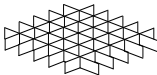
- SOFT START** Progressive start of the wash pump
 - BT - WRAS** Booster pump included
 - 220-240 V 50 HZ** For DUPLA 50 max boiler heating element 4500 W
- Option compatibility to be confirmed by the manufacturer after verification
 Water supply 55 °C
 EAC label upon request

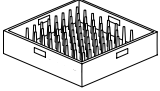
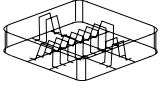
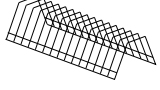
	Description	Capacity	Dimensions	Code
	GLASS BASKET		350x350x110 H 400x400x135 H 370x370x130 H	10730 C 121 C 10
	SLOPED GLASS BASKET	Ø 85 max Ø 100 max	370x370x210 H 500x500x200 H	C 39 C 26
	REUSABLE CUP BASKET	5x5 Glass 30 < Ø < 90 mm H max 185 mm	500x500x235 H	C 135 
	SLOPED GLASS BASKET	Ø 90 max Ø 120 max	400x400x185 H 400x400x160 H	C 123 C 79
	NARROW MESH CUTLERY BASKET		500x500x106 H	C 41
	LARGE MESH BASKET	For glasses	500x500x105 H	C 44
	ROUND GLASS BASKET	Basket Support	Ø 390x170 H 400x400	C 145 C 143
	HOLDER FOR GLASS SUPPORT	For glass support (C112-C113-C114)	500x500x50 H	C 111
	GLASS SUPPORT	5x5 Glass Ø 87 mm (C111)	500x500x50 H	C 112
	GLASS SUPPORT	4x4 Glass Ø 110 mm (C111)	500x500x50 H	C 113
	GLASS SUPPORT	6x6 Glass Ø 72 mm (C111)	500x500x50 H	C 114

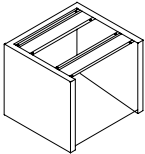
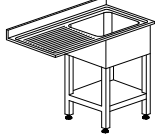
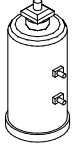
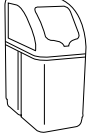
	Description	Capacity	Dimensions	Code	
	PLATE BASKET	18 plates	500x500x105 H	C 40	
	PLATE BASKET	10 plates	370x370x100 H	C 03	
		12 plates	400x400x120 H	C 31	
	SAUCER HOLDER	14 saucers	300x100x90 H	10728	
	CUTLERY BASKET		110x110x120 H	15060	
	SUPPORT	Stainless steel stand for undercounter 500 x 500	592x535x500 H	999900517	
	SINK UNIT FOR UNDERCOUNTER MODELS	Sink 500x400x300 H	1200x700x850 H	K 5/20 *	
	WATER SOFTENER	12 l	Ø 200x500 H	DEP 12	
	AUTOMATIC WATER SOFTENER	12 l (max 800 l)	315x510x685 H	DEP 12-AUT	

* Wooden cage +2% minimum + €
Special dimensions for tables upon request
Tables shown in right-to-left version



Latest generation KROMO dishwashers. These machines are built with fully double-skin body, completely deep-formed, designed for being silent and reliable. Beside the standard electronic versions with four programmable cycles, we have developed the PLUS models with guaranteed steady rinse temperature and pressure and two cycles with Hygiene+ superior features (LUX 60 EL).

Thanks to these latest technological features, the sturdy PLUS versions will promote the almost total elimination of the bacterial load. The customization of our new generation machines has never been so easy!

A₀=30
HYGIENE +

HYGIENE+ SYSTEM

The HYGIENE+ models perform long cycles at high temperatures to fulfill high levels of hygiene, now more essential than ever for our health. Designed and conceived upon rigorous disinfection parameters, the HYGIENE+ models include 2 special cycles complying with A₀=30 on the scale of thermo-disinfection according to the norm EN ISO 15883-1, a short one program of 180 seconds and a longer one of 630 seconds, ensuring compliance with high levels of hygiene thanks to high temperatures and long cycles.



FEATURES

- Double skin AISI 304 machine and double skin insulated door
- Soft door opening and programmable START function when the door gets closed
- Sloped deep-formed tank
- Deep-formed rack supports
- Anti-drop roof panel
- Double tight-mesh filter system in stainless steel
- Wash arms in stainless steel with unblockable nozzles and lightweight rinse arms in composite material
- Suitable for Gastronorm 1/1 trays
- Intuitive electronic control panel with displayed wash and rinse temperatures
- START button with multicolour backlight for a quick visualization of the machine status
- Multivoltage
- Programmable wash cycles
- HYGIENE+ Version: 2 special additional programs complying with A₀=30 according to the norm EN ISO 15883-1
- Self-cleaning cycle
- Built-in peristaltic detergent dispenser and built-in rinse-aid dispenser (peristaltic rinse-aid dispenser included in the PLUS versions)
- Detergent and rinse-aid dosage setting, directly from the control panel (detergent dispenser only on non-PLUS models)
- PLUS system for extra rinse guarantee (PLUS models)
- OPTIMAL-RINSE (optimal rinse technology): water consumption rate among the lowest on the market, consequent reduction of electricity and chemicals consumptions
- Water consumption and working time control system (PLUS models)
- Anti back-flow valve available also DVGW or WRAS certified
- Soft Start wash pump
- Thermal insulation of boiler
- Built-in automatic water softener available
- CONNECTIVITY remote control compliant with the HACCP norms (on request)
- Cold water rinse (on request)
- Reverse osmosis connection for external device (PLUS models)

CONNECTIVITY 4.0 & APP

WHEREVER YOU ARE...
YOUR DISHWASHER, JUST A CLICK AWAY

You will be constantly connected to the machine to monitor the work phases, review any eventual alarm and configure remotely the operating parameters according to your needs. Compliant with HACCP norms. Thanks to our brand new App, you will have access to connected machines and all commercial and technical documentation.

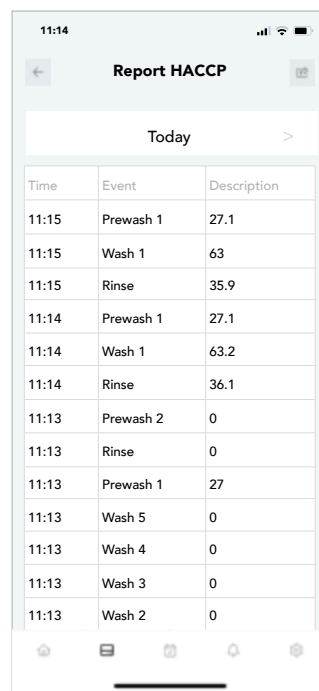
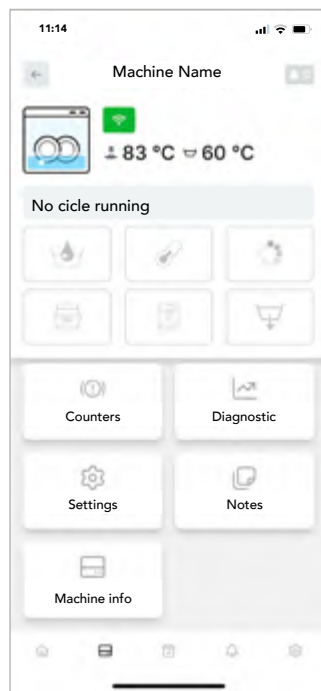

View all the working parameters and event records, working hours and any problem at any time.



In case of problem, the machine promptly alerts you. The technician can intervene remotely to solve the problem or anticipate the needed parts for an on-site intervention.



A daily activity report is available with all the events related to the dishwasher in a detailed spreadsheet with HACCP data.



Our Connectivity system is a revolutionary device limiting and facilitating the eventual intervention of a technician who can anticipate the necessary parts to be replaced, saving time and money.

PLUS SYSTEM

GUARANTEED RINSE EVEN WITH LOW PRESSURE OF THE WATER INLET

We have developed an innovative rinsing system at constant temperature, consumption and water pressure, regardless of external conditions. The PLUS System ensures optimal and constant rinsing performance thanks to the combination of Break Tank, atmospheric boiler and rinse pump.

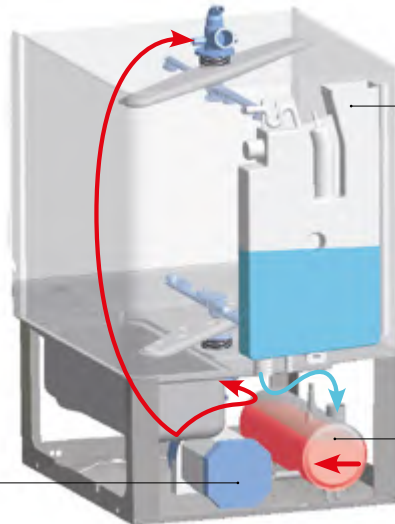

BREAK TANK

The Break Tank system prevents the heated water of the boiler to go back and mix with the fresh water supply.

ATMOSPHERIC BOILER

The water temperature in the boiler remains constant at 85°C throughout the rinse, as the boiler refill only occurs once the rinse cycle is done.

RINSE PUMP

The water is sucked from the boiler through a rinse pump and is sent to the rinse nozzles. The correct pressure is ensured regardless of the water inlet pressure and temperature.











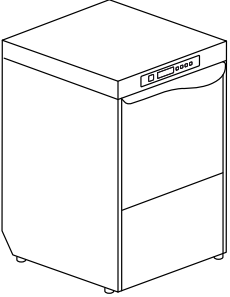



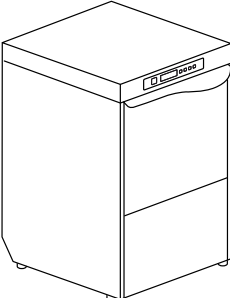

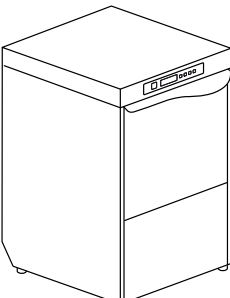

ENERGY RECOVERY



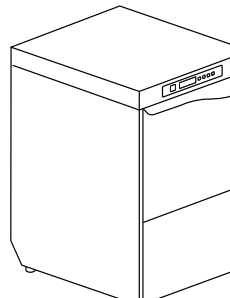







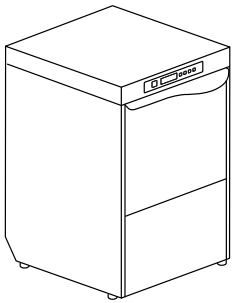

(Heat recovery and steam condenser)

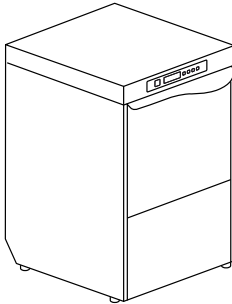
The ENERGY RECOVERY system uses the heat produced by the machine to preheat the inlet cold water. This is an immediate saving on energy costs. Additionally, an optimal temperature in the dishwashing area is achieved as the air is no more affected by steam and humidity.

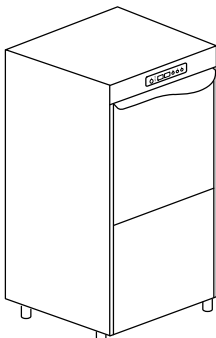

Heat Recovery

Model		Voltage	Capacity	Dimensions	Code
LUX 40 EL ELECTRONIC 4 PROGRAMS					
	<p>RACK EQUIPMENT</p> <ul style="list-style-type: none"> 2 X C121 1 X 10728 1 X 15060 	<p>Multivoltage</p> <ul style="list-style-type: none"> standard 230 V 50 Hz 3,05 kW -- 230 V 3 50 Hz 4,45 kW -- 400 V 3N 50 Hz 4,45 kW 	<ul style="list-style-type: none">  310 H  ø 310  400x400 	<p>460x550x780 H</p> <p>45 kg</p>	<p>LUX 40 EL</p> <p>LUX 40 EL DA</p>
LUX 60 EL ELECTRONIC 4 PROGRAMS					
	<p>RACK EQUIPMENT</p> <ul style="list-style-type: none"> 1 X C40 1 X C44 1 X 15060 	<p>Multivoltage</p> <ul style="list-style-type: none"> standard 400 V 3N 50 Hz 5,15 kW -- 230 V 3 50 Hz 5,15 kW -- 230 V 50 Hz 5,15 kW 	<ul style="list-style-type: none">  325 H  ø 340  500x500 	<p>600x610x850 H</p> <p>63,5 kg</p> <p> GN 1/1</p> <p>530x325x25 H</p>	<p>LUX 60 EL</p> <p>LUX 60 EL DA</p>
LUX 60 EL H+ ELECTRONIC 4 PROGRAMS					
	<p>A₀=30 HYGIENE +</p> <p>RACK EQUIPMENT</p> <ul style="list-style-type: none"> 1 X C40 1 X C44 1 X 15060 	<p>Multivoltage</p> <ul style="list-style-type: none"> standard 400 V 3N 50 Hz 5,15 kW -- 230 V 3 50 Hz 5,15 kW -- 230 V 50 Hz 5,15 kW 	<ul style="list-style-type: none">  325 H  ø 340  500x500 	<p>600x610x850 H</p> <p>63,5 kg</p> <p> GN 1/1</p> <p>530x325x25 H</p>	<p>LUX 60 EL H+</p> <p>LUX 60 EL DA H+</p>
LUX 70 EL ELECTRONIC 4 PROGRAMS					
	<p>RACK EQUIPMENT</p> <ul style="list-style-type: none"> 1 X C40 1 X C44 1 X 15060 	<p>Multivoltage</p> <ul style="list-style-type: none"> standard 400 V 3N 50 Hz 6,7 kW -- 230 V 3 50 Hz 6,7 kW -- 230 V 50 Hz 6,7 kW 	<ul style="list-style-type: none">  400 H  ø 400  500x500 	<p>600x680x850 H</p> <p>68 kg</p> <p> 600x400x25 H</p> <p> GN 1/1</p> <p>530x325x25 H</p>	<p>LUX 70 EL</p> <p>LUX 70 EL DA</p> <p>Surface filters</p>

Model	Voltage	Capacity	Dimensions	Code	
LUX 40 EL PLUS ELECTRONIC 4 PROGRAMS - HR: HEAT RECOVERY					
 <div style="border: 1px solid black; padding: 5px; margin-top: 10px;"> <p>RACK EQUIPMENT 2 X C121 1 X 10728 1 X 15060</p> </div>	Multivoltage	 310 H	460x550x780 H 46,5 kg	LUX 40 EL PLUS	
	standard 230 V 50 Hz 3,25 kW			 ø 310	LUX 40 EL PLUS DA
	230 V 3 50 Hz 4,75 kW	 400x400			LUX 40 EL HR PLUS
	400 V 3N 50 Hz 4,75 kW HR: Cold water supply				LUX 40 EL HR PLUS DA
LUX 60 EL PLUS H+ ELECTRONIC 6 PROGRAMS - HR: HEAT RECOVERY					
 <div style="border: 1px solid black; padding: 5px; margin-top: 10px;"> <p>A₀=30 HYGIENE+</p> <p>RACK EQUIPMENT 1 X C40 1 X C44 1 X 15060</p> </div>	Multivoltage	 325 H	600x610x850 H 65 kg	LUX 60 EL PLUS H+	
	standard 400 V 3N 50 Hz 5,15 kW			 ø 340	LUX 60 EL PLUS DA H+
	230 V 3 50 Hz 5,15 kW	 500x500			LUX 60 EL HR PLUS H+
	230 V 50 Hz 5,15 kW HR: Cold water supply				LUX 60 EL HR PLUS DA H+
* Kit Bottlewasher					
LUX 85 EL PLUS ELECTRONIC 4 PROGRAMS					
IMPROVED					
 <div style="border: 1px solid black; padding: 5px; margin-top: 10px;"> <p>RACK EQUIPMENT 1 X C40 1 X C43 1 X C44 1 X 15060</p> </div>	Multivoltage	 440 H	600x700x1380 H 87 kg	LUX 85 EL PLUS	
	standard 400 V 3N 50 Hz 10,12 kW				 ø 450
	230 V 3 50 Hz 10,12 kW	 500x500			
	230 V 50 Hz 10,12 kW				

- A₀=30** Special programs complying with A₀=30 on the scale of thermo-disinfection according to the norm EN ISO 15883-1. The HYGIENE+ models include 2 special cycles, a short one of 180 seconds and a longer one of 630 seconds, ensuring compliance with high levels of hygiene thanks to high temperatures and long cycles.
- PLUS** Rinse with constant temperature, pressure and stabilized consumption
- X** With special basket to be ordered
- HR** Heat recover
- *** Kit for upgrading to Bottlewasher version (contact manufacturer to verify compatibility with model version).

OPTIONS

Model	220-240V 50 Hz	380-415V 3N 50 Hz	220-240V 3.50 Hz	380-415V 3.50 Hz	440V 3.60 Hz	60 Hz	RO Osmosis connection	XP Extra power	PS Drain pump	DDE Detergent dispenser	DB Rinse-aid dispenser	DBE Peristaltic rinse-aid disp.
LUX 40 EL	●	M	M	----	----	€	----	□	€	●	●	€
LUX 40 EL DA	●	M	M	----	----	€	----	□	€	●	●	€
LUX 60 EL	M	●	M	€	€	€	----	€	€	●	●	€
LUX 60 EL DA	M	●	M	----	----	€	----	€	€	●	●	€
LUX 60 EL H+	M	●	M	€	€	€	----	€	€	●	●	€
LUX 60 EL DA H+	M	●	M	----	----	€	----	€	€	●	●	€
LUX 70 EL	□	●	M	----	----	€	----	----	€	●	●	€
LUX 70 EL DA	□	●	M	----	----	€	----	----	€	●	●	€
LUX 40 EL PLUS	●	M	M	----	----	€	□	□	€	●	----	●
LUX 40 EL PLUS DA	●	M	M	----	----	€	----	□	€	●	----	●
LUX 40 EL HR PLUS	●	M	M	----	----	€	□	□	€	●	----	●
LUX 40 EL HR PLUS DA	●	M	M	----	----	€	----	□	€	●	----	●
LUX 60 EL PLUS H+	M	●	M	€	€	€	□	€	€	●	----	●
LUX 60 EL PLUS DA H+	M	●	M	----	----	€	----	€	€	●	----	●
LUX 60 EL HR PLUS H+	M	●	M	€	€	€	□	€	€	●	----	●
LUX 60 EL HR PLUS DA H+	M	●	M	----	----	€	----	€	€	●	----	●
LUX 85 EL PLUS	M	●	M	----	----	€	----	€	€	●	----	●

● Standard

---- Not available

□ Upon request

DA Built-in water softener with automatic regeneration

M Multivoltage

XP Recommended with water 8-55 °C. For LUX 40 EL only with standard voltage.
For other voltages please contact us

Water supply 55 °C (not on HR version)

EAC label upon request

Model	ST	FS	CR	PS+FS	TS	CONN.	BT	WRAS	DVGW	PAP	FLOAT	DF
	Soft start	Cold rinse	Round basket	PS + FS	Thermostop system	Connectivity (Haccp)	Break tank	WRAS	DVGW	Booster pump	Probes lack det. and rinse aid	Surface filters kit
LUX 40 EL	●	€	€	€	●	€	€	€	€	€	€	----
LUX 40 EL DA	●	----	€	----	●	€	----	----	----	€	€	----
LUX 60 EL	●	€	----	€	●	€	€	€	€	€	€	----
LUX 60 EL DA	●	----	----	----	●	€	----	€	€	€	€	----
LUX 60 EL H+	●	€	----	€	●	€	€	€	€	€	€	----
LUX 60 EL DA H+	●	----	----	----	●	€	----	€	€	€	€	----
LUX 70 EL	●	€	----	€	●	€	€	€	€	€	€	€
LUX 70 EL DA	●	----	----	----	●	€	----	€	€	----	€	€
LUX 40 EL PLUS	●	€	€	€	●	€	●	€	€	●	€	----
LUX 40 EL PLUS DA	●	----	€	----	●	€	----	----	----	●	€	----
LUX 40 EL HR PLUS	●	----	€	----	●	€	●	----	----	●	€	----
LUX 40 EL HR PLUS DA	●	----	€	----	●	€	----	----	----	●	€	----
LUX 60 EL PLUS H+	●	€	----	€	●	€	●			●	€	----
LUX 60 EL PLUS DA H+	●	----	----	----	●	€	----	---	---	●	€	----
LUX 60 EL HR PLUS H+	●	----	----	----	●	€	●	----	----	●	€	----
LUX 60 EL HR PLUS DA H+	●	----	----	----	●	€	----	----	----	●	€	----
LUX 85 EL PLUS	●	----	----	----	●	€	●	€	€	●	€	----

380-415 V 3N 50 HZ For the models LUX 40 EL "upon request" provide extra power
220-240 V 3 50 HZ

220 -240 V 50 HZ For the models LUX 85 EL PLUS max boiler heating element 6000 W

CONNECTIVITY Includes HACCP option. 10 year plan

BT - WRAS Booster pump included









DVGW Components prescribed by DVGW on request (check option compatibility with the manufacturer)

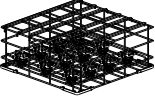
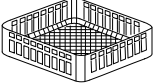

SOFT START Progressive start of the wash pump

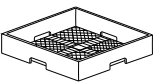
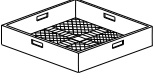
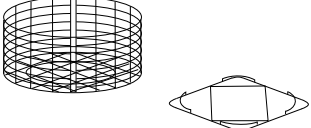
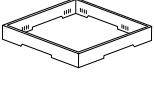
H+ (HYGIENE+) 2 cycles of 630 and 180 seconds with high temperatures, reaching up to 70 °C for washing and 90°C for rinsing

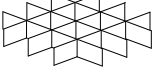
All models: independent wash and rinse arms

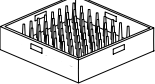
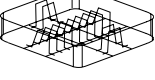
Option compatibility to be confirmed by the manufacturer after verification

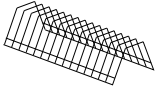
	Description	Capacity	Dimensions	Code	
	NARROW MESH BOTTLES BASKET	12 bottles LUX 60 EL PLUS H+	500x500x205 H	C 140	
	GLASS BASKET		400x400x135 H	C 121	
	SLOPED GLASS BASKET	Ø 100 max	500x500x200 H	C 26	
	REUSABLE CUP BASKET	5x5 Glass 30 < Ø < 90 mm H max 185 mm	500x500x235 H	C 135 	
	SLOPED GLASS BASKET	Ø 90 max Ø 120 max	400x400x185 H 400x400x160 H	C 123 C 79	
	NARROW MESH CUTLERY BASKET		500x500x106 H	C 41	
	LARGE MESH BASKET	For glasses	500x500x105 H	C 44	
	ROUND GLASS BASKET ROUND BASKET SUPPORT	Basket Support	Ø 390x170 H 400x400	C 145 C 143	
	HOLDER FOR GLASS SUPPORT	For glass support (C112-C113-C114)	500x500x50 H	C 111	
	GLASS SUPPORT	5x5 Glass Ø 87 mm (C111)	500x500x50 H	C 112	
	GLASS SUPPORT	4x4 Glass Ø 110 mm (C111)	500x500x50 H	C 113	
	GLASS SUPPORT	6x6 Glass Ø 72 mm (C111)	500x500x50 H	C 114	
	PLATE BASKET	18 plates	500x500x105 H	C 40	
	PLATE BASKET	12 plates	400x400x120 H	C 31	

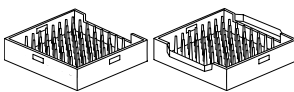
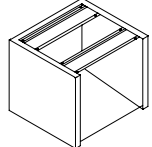
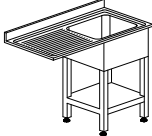
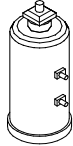
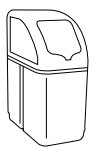
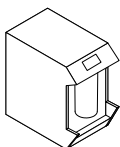
	Description	Capacity	Dimensions	Code	
	SAUCER HOLDER	14 saucers	300x100x90 H	10728	
	CUTLERY BASKET		110x110x120 H	15060	
	GASTRONORM TRAYS BASKET	6 pcs, max. depth 25 mm	500x500x105 H 500x500x105 H	C 43 C 43/B	
	SUPPORT	Stainless steel stand for undercounter 500 x 500	592x535x500 H	999900517	
	SINK UNIT FOR UNDERCOUNTER MODELS	Sink 500x400x300H	1200x700x850 H	K 5/20 *	
	WATER SOFTENER	12 l	Ø 200x500 H	DEP 12	
	AUTOMATIC WATER SOFTENER	12 l (max 800 l)	315x510x685 H	DEP 12-AUT	
	OSMOSIS FOR PLUS MODELS	230 V 50 Hz - 250 W 5° C - 35° C Flow rate 240 l/h Not suitable for machine with integrated water softener Special basket dotation	226x522x452 H 20 Kg	K OS240 +	

* Wooden cage +2% minimum + €
Special dimensions for tables upon request
Tables shown in right-to-left version

BOTTLE COMBI LUX PLUS

HIGH-TECH DOUBLE SKIN
BOTTLEWASHER



Environmental concerns are part of our daily lives. KROMO's vision is to minimize the use of environmental resources and operating costs of our customers. To this end, we created a bottle washer with the high-end characteristics of the LUX 60 EL. The real competitive advantage of the

KROMO bottle washer on the market is that the latter does not only rinse but also perfectly washes the inner and outer parts of the bottles. This model allows all users to commit to promoting a sustainable future and is easily convertible into an LUX EL dishwasher.



FEATURES

- Easily convertible into an LUX EL glass or dishwasher, thanks to the standard dotation of wash and rinse arms as parts (for the dishwasher version, add a C40 plates basket)
- Double skin AISI 304 machine and double skin insulated door
- Sloped deep-formed tank
- Upper wash arms in stainless steel with unblockable nozzles and lightweight upper rinse arms in composite material
- Bottle washer dispenser instead of lower arms and dedicated basket
- Deep-formed rack supports
- Anti-drop roof panel
- Capacity 12 bottles with the dedicated basket supplied in dotation: max height 325 mm
- Possibility to wash polypropylene containers and bottles
- 4 programmable cycles
- Special cycle for bottles
- Multivoltage
- Self-cleaning cycle
- Built-in peristaltic detergent dispenser and built-in rinse-aid dispenser
- Detergent and rinse-aid dosage setting, directly from the control panel
- Wash and rinse temperatures displayed
- Double tight-mesh filter system in stainless steel
- Intuitive START button with multicolour backlight for a quick visualization of the machine status
- Soft Start wash pump
- Thermal insulation of boiler
- Soft door opening and programmable START function when the door gets closed
- D: Built-in water softener recommended for water > 8°f; max 35°f
- Water consumption and working time control system
- PLUS system for extra rinse guarantee
- CONNECTIVITY remote control compliant with the HACCP norms (on request)
- Heat recovery steam condensing unit for cold water supply (PLUS versions)

BOTTLE COMBI LUX PLUS

HIGH-TECH DOUBLE SKIN
BOTTLEWASHER

CONNECTIVITY 4.0 & APP

WHEREVER YOU ARE...
YOUR DISHWASHER, JUST A CLICK AWAY

You will be constantly connected to the machine to monitor the work phases, review any eventual alarm and configure remotely the operating parameters according to your needs. Compliant with HACCP norms. Thanks to our brand new App, you will have access to connected machines and all commercial and technical documentation.

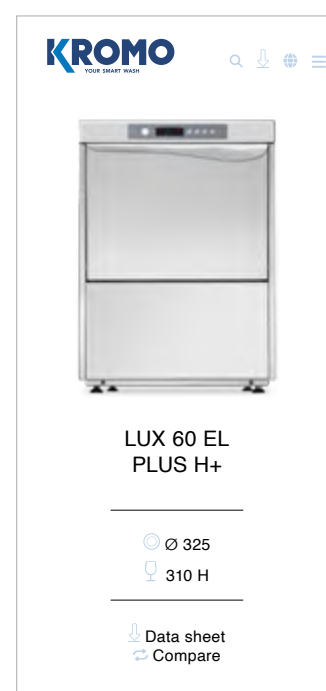
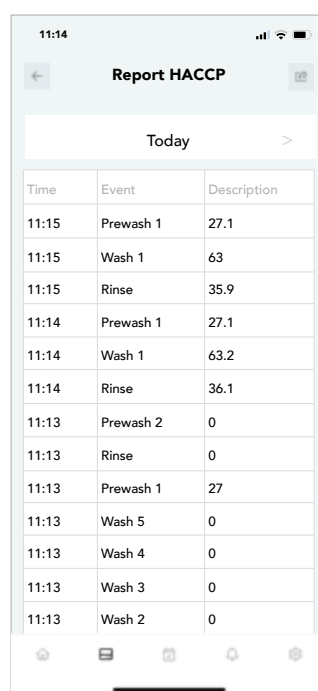
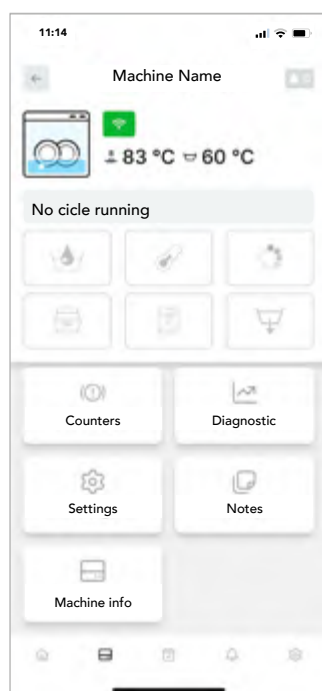
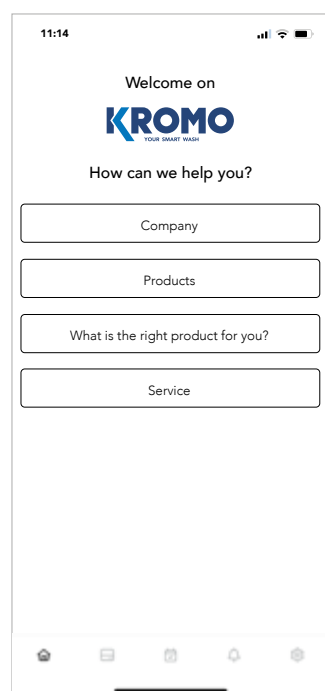

View all the working parameters and event records, working hours and any problem at any time.



In case of problem, the machine promptly alerts you. The technician can intervene remotely to solve the problem or anticipate the needed parts for an on-site intervention.



A daily activity report is available with all the events related to the dishwasher in a detailed spreadsheet with HACCP data.



Our Connectivity system is a revolutionary device limiting and facilitating the eventual intervention of a technician who can anticipate the necessary parts to be replaced, saving time and money.

PLUS SYSTEM

GUARANTEED RINSE EVEN WITH LOW PRESSURE OF THE WATER INLET

We have developed an innovative rinsing system at constant temperature, consumption and water pressure, regardless of external conditions. The PLUS System ensures optimal and constant rinsing performance thanks to the combination of Break Tank, atmospheric boiler and rinse pump.

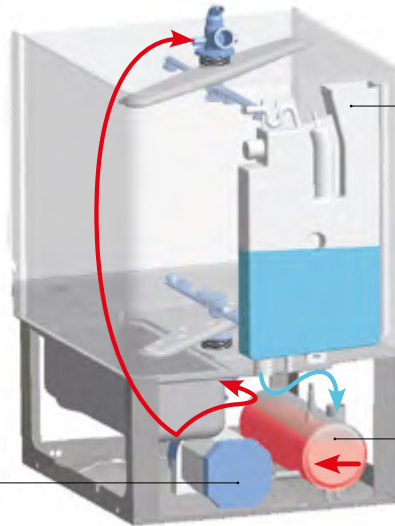

BREAK TANK

The Break Tank system prevents the heated water of the boiler to go back and mix with the fresh water supply.

ATMOSPHERIC BOILER

The water temperature in the boiler remains constant at 85°C throughout the rinse, as the boiler refill only occurs once the rinse cycle is done.

RINSE PUMP

The water is sucked from the boiler through a rinse pump and is sent to the rinse nozzles. The correct pressure is ensured regardless of the water inlet pressure and temperature.

ENERGY RECOVERY

(Heat recovery and steam condenser)



The ENERGY RECOVERY system uses the heat produced by the machine to preheat the inlet cold water. This is an immediate saving on energy costs. Additionally, an optimal temperature in the dishwashing area is achieved as the air is no more affected by steam and humidity.



Heat Recovery

BOTTLE COMBI LUX PLUS

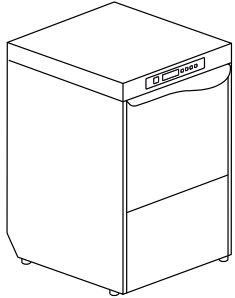
HIGH-TECH DOUBLE SKIN
BOTTLEWASHER

Model	Voltage	Capacity	Dimensions	Code
BOTTLE COMBI LUX PLUS ELECTRONIC 4 PROGRAMS - HR: HEAT RECOVERY				
 <div data-bbox="375 472 566 645" style="border: 1px solid black; padding: 5px; margin-top: 10px;"> RACK EQUIPMENT 1 X C140 1 X C44 </div>	Multivoltage	 325 H Ø bottle neck 16<Ø<50 mm Ø max bottle 113 mm	600x610x850 H 70 kg HRversion: 72 Kg	BOTTLE COMBI LUX PLUS
	standard			BOTTLE COMBI LUX PLUS DA
	400 V 3N 50 Hz 6,65 kW --			BOTTLE COMBI LUX HR PLUS
	230 V 3 50 Hz 6,65 kW --			BOTTLE COMBI LUX HR PLUS DA
230 V 50 Hz 6,65 kW				

BOTTLE COMBI LUX PLUS

HIGH-TECH DOUBLE SKIN
BOTTLEWASHER

OPTIONS

	220-240 V 50 Hz		380-415 V 3N 50 Hz		220-240 V 3 50 Hz		380-415 V 3 50 Hz		440 V 3 60 Hz		60 Hz	RO	PS	DDE	DBE
Model												Osmosis connection	Drain Pump	Detergent dispenser	Peristaltic rinse-aid disp.
BOTTLE COMBI LUX PLUS	M	●	M	€	€	€	€	€	€	€	€	□	€	●	●
BOTTLE COMBI LUX PLUS DA	M	●	M	----	----	€	€	€	€	€	€	----	€	●	●
BOTTLE COMBI LUX HR PLUS	M	●	M	€	€	€	€	€	€	€	€	□	€	●	●
BOTTLE COMBI LUX HR PLUS DA	M	●	M	----	----	€	€	€	€	€	€	----	€	●	●

- Standard
- Not available
- Upon request
- DA** Built-in water softener with automatic regeneration
- M** Multivoltage

Water supply 55 °C (not on HR version)

EAC label upon request

Model	ST	FS	PS+FS	TS	CONNECTIVITY	BT	WRAS	DVGW	PAP	FLOAT
	Soft start	Cold rinse	PS + FS	Electronic timer+ thermostat system	Connectivity (HACCP)	Break tank	WRAS	DVGW	Booster pump	Probes lack det. and rinse aid
BOTTLE COMBI LUX PLUS	●	€	€	●	€	●	€	€	●	€
BOTTLE COMBI LUX PLUS DA	●	----	----	●	€	----	----	----	●	€
BOTTLE COMBI LUX HR PLUS	●	----	----	●	€	●	----	----	●	€
BOTTLE COMBI LUX HR PLUS DA	●	----	----	●	€	----	----	----	●	€

CONNECTIVITY Includes HACCP option. 10 year plan







DVGW Components prescribed by DVGW on request (check option compatibility with the manufacturer)

SOFT START Progressive start of the wash pump

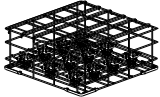
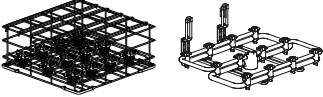
Option compatibility to be confirmed by the manufacturer after verification

BOTTLE COMBI LUX PLUS

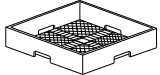
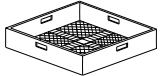
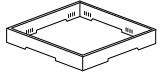
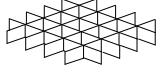
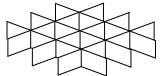
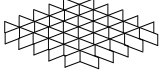
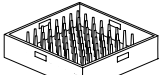
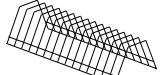
ACCESSORIES

	Description	Capacity	Dimensions	Code
	NARROW MESH BOTTLES BASKET	12 bottles	500x500x205 H	C 140
	BOTTLE COMBI KIT	rack C 140 + griddle with nozzles		BOTTLE COMBI KIT
	SLOPED GLASS BASKET	Ø 100 max	500x500x200 H	C 26
	REUSABLE CUP BASKET	5x5 Glass 30 < Ø < 90 mm H max 185 mm	500x500x235 H	C 135 
	NARROW MESH CUTLERY BASKET		500x500x106 H	C 41
	LARGE MESH BASKET	For glasses	500x500x105 H	C 44
	HOLDER FOR GLASS SUPPORT	For glass support (C112-C113-C114)	500x500x50 H	C 111
	GLASS SUPPORT	5x5 Glass Ø 87 mm (C111)	500x500x50 H	C 112
	GLASS SUPPORT	4x4 Glass Ø 110 mm (C111)	500x500x50 H	C 113
	GLASS SUPPORT	6x6 Glass Ø 72 mm (C111)	500x500x50 H	C 114
	PLATE BASKET	18 plates	500x500x105 H	C 40
	SAUCER HOLDER	14 saucers	300x100x90 H	10728
	CUTLERY BASKET		Ø 120x120 H	15060

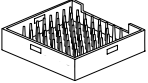
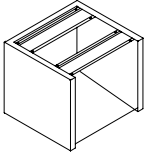
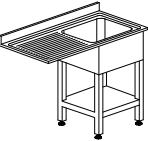
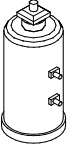
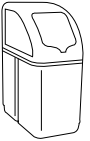
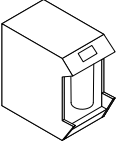
	Description	Capacity	Dimensions	Code	
	GASTRONORM TRAYS BASKET	6 pcs, max. depth 25 mm	500x500x105 H 500x500x105 H	C 43 C 43/B	
	SUPPORT	Stainless steel stand	592x535x500 H	999900517	
	SINK UNIT FOR UNDERCOUNTER MODELS	Sink 500x400x300 H	1200x700x850 H	K 5/20 *	
	WATER SOFTENER	12 l	Ø 200x500 H	DEP 12	
	AUTOMATIC WATER SOFTENER	12 l (max 800 l)	315x510x685 H	DEP 12-AUT	
	OSMOSIS FOR PLUS MODELS	230 V 50 Hz - 250 W 5° C - 35° C Flow rate 240 l/h Not suitable for machine with integrated water softener Special basket dotation	226x522x452 H 20 Kg	K OS240 +	

* Wooden cage +2% minimum + €
Special dimensions for tables upon request
Tables shown in right-to-left version



We simply combined the highest specs and ultimate new technology to the time-tested name and features. PREMIUM is our answer to the new high standards of hygiene and cleanliness of the worldwide market, keeping our renowned low operating costs thanks to the Optimal Rinse system. Our HYGIENE+ cycles will guarantee to work safely by keeping top sanitation levels. The compact model with lower usable height, the settable additional cycle and the available self-monitoring technology and Connectivity makes the

PREMIUM the range you have been expecting. An intuitive and interactive electronic panel will lead you through the new functions of your dishwasher. Its self-diagnosis system notifies any anomaly and clearly shows the different steps of the cycle and status of your dishwasher. Eight wash cycles (ten for the HYGIENE+ version) and the easy change of voltage make these machines incredibly versatile and easy to install.

A₀=60
HYGIENE +

HYGIENE+ SYSTEM

Our HYGIENE + models, with high temperatures and long cycles, ensure compliance with high levels of hygiene, nowadays more essential than ever for our personal health. We designed this range according to strict standards and parameters of thermal disinfection. All our HYGIENE + models obtain the A₀ 60 level, reducing pathogenic microorganisms and bacterial load according to the norm EN ISO 15883-1. Two cycles with high temperatures (180 and 630 seconds), reaching up to 75°C for washing and 90°C for rinsing, guarantee a full compliance with the disinfection principles.



FEATURES

- OPTIMAL-RINSE (optimal rinse technology): water consumption rate among the lowest on the market, consequent reduction of electricity and chemicals consumptions
- Soft door opening and programmable START function when the door gets closed
- Combined system of wash and rinse arms in stainless steel with unblockable nozzles
- Innovative S/S filter improving the filtration of the wash water
- Partial drain of the waste wash water before rinsing
- Standard version: Eight wash cycles, six with partial drain of the wash water and two with total drain of the wash water before rinsing
- HYGIENE+ version: Ten wash cycles, six with partial drain of the wash water, two with total drain of the wash water before rinsing and two HYGIENE+ programs
- Double skin machine and double skin insulated door
- Electronic control panel with TFT screen and multichromatic START key to instantly view all functions
- Self-diagnostic system with two different control levels for user and service people depending on the failure
- Easy-change voltage setting, directly from the cables connection
- Water consumption and working time control system
- Detergent and rinse-aid peristaltic dispensers included
- Detergent and rinse-aid dosage setting, directly from the control panel
- Built-in drain pump
- Thermostop with Energy Saving device
- Self-cleaning cycle
- Soft Start wash pump that offers additional protection for the most delicate objects
- Thermal insulation of boiler
- CONNECTIVITY remote control compliant with the HACCP norms (on request)
- D: built-in water softener recommended for water > 8°f; max 35°f
- Heat recovery steam condensing unit for cold water supply

CONNECTIVITY 4.0 & APP

WHEREVER YOU ARE...

YOUR DISHWASHER, JUST A CLICK AWAY

You will be constantly connected to the machine to monitor the work phases, review any eventual alarm and configure remotely the operating parameters according to your needs. Compliant with HACCP norms. Thanks to our brand new App, you will have access to connected machines and all commercial and technical documentation.

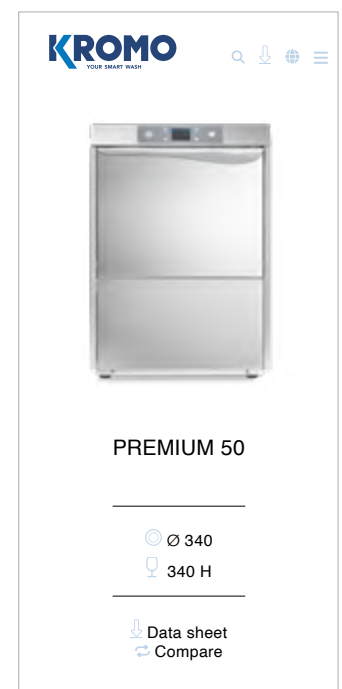
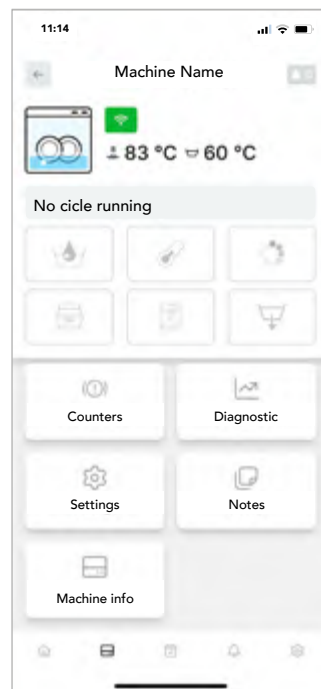

View all the working parameters and event records, working hours and any problem at any time.



In case of problem, the machine promptly alerts you. The technician can intervene remotely to solve the problem or anticipate the needed parts for an on-site intervention.



A daily activity report is available with all the events related to the dishwasher in a detailed spreadsheet with HACCP data.



Our Connectivity system is a revolutionary device limiting and facilitating the eventual intervention of a technician who can anticipate the necessary parts to be replaced, saving time and money.

PLUS SYSTEM

GUARANTEED RINSE EVEN WITH LOW PRESSURE OF THE WATER INLET

We have developed an innovative rinsing system at constant temperature, consumption and water pressure, regardless of external conditions. The PLUS System ensures optimal and constant rinsing performance thanks to the combination of Break Tank, atmospheric boiler and rinse pump.



STEADY WATER TEMPERATURE IN THE BOILER (85°C)



STABILIZED PRESSURE THROUGHOUT THE RINSE PHASE



CLEANER WATER LESS WASTE

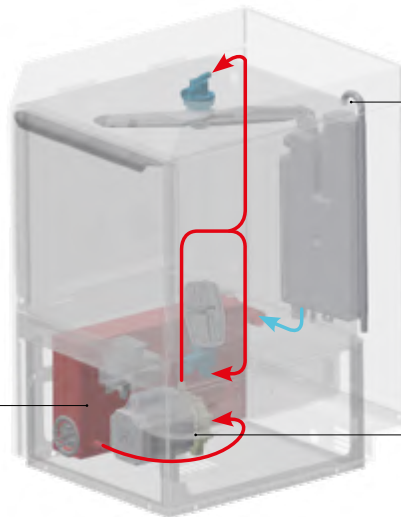

BREAK TANK

The Break Tank system prevents the heated water of the boiler to go back and mix with the fresh water supply.

ATMOSPHERIC BOILER

The water temperature in the boiler remains constant at 85°C throughout the rinse, as the boiler refill only occurs once the rinse cycle is done.

RINSE PUMP

The water is sucked from the boiler through a rinse pump and is sent to the rinse nozzles. The correct pressure is ensured regardless of the water inlet pressure and temperature.

ENERGY RECOVERY

(Heat recovery and steam condenser)











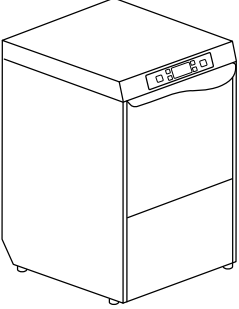

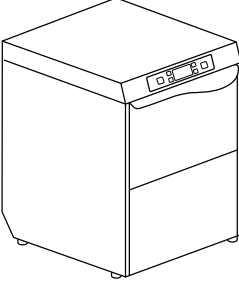

The ENERGY RECOVERY system uses the heat produced by the machine to preheat the inlet cold water. This is an immediate saving on energy costs. Additionally, an optimal temperature in the dishwashing area is achieved as the air is no more affected by steam and humidity.



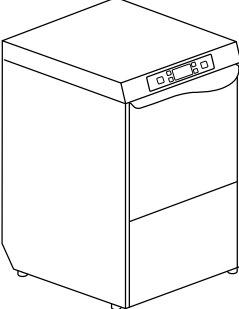



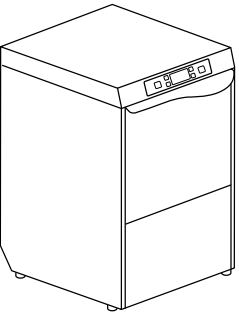

Heat Recovery

PREMIUM

GLASS AND DISHWASHERS
WITH CLEAN WATER TECHNOLOGY

Model		Voltage	Capacity	Dimensions	Code
PREMIUM 40 ELECTRONIC 8 PROGRAMS - HR: HEAT RECOVERY					
	<p>RACK EQUIPMENT</p> <p>2 X C121 1 X 10728 1 X 15060</p> 	Multivoltage			PREMIUM 40
		standard	 310 H		PREMIUM 40 DA
		230 V 50 Hz	 Ø 310	460x550x780 H 47 kg	PREMIUM 40 HR
		3,25 kW	 400x400		PREMIUM 40 HR DA
		--			
		230 V 3 50 Hz			
		4,75 kW			
		--			
		400 V 3N 50 Hz			
		4,75 kW			
		--			
		HR:			
		Cold			
		water supply			
PREMIUM 50 SMALL ELECTRONIC 8 PROGRAMS - HR: HEAT RECOVERY					
	<p>RACK EQUIPMENT</p> <p>1 X C40 1 X C44 1 X 15060</p> 	Multivoltage			PREMIUM 50 SMALL
		standard	 260 H		PREMIUM 50 SMALL DA
		400 V 3N 50 Hz	 Ø 260	600x610x730 H 60 kg	PREMIUM 50 HR SMALL
		6,35 kW	 500x500		PREMIUM 50 HR SMALL DA
		--			
		230 V 3 50 Hz			
		6,35 kW			
		--			
		230 V 50 Hz			
		6,35 kW			
		--			
		HR:			
		Cold			
		water supply			
PREMIUM 50 ELECTRONIC 8 PROGRAMS - HR: HEAT RECOVERY					
	<p>RACK EQUIPMENT</p> <p>1 X C40 1 X C44 1 X 15060</p> 	Multivoltage			PREMIUM 50
		standard	 340 H		PREMIUM 50 DA
		400 V 3N 50 Hz	 Ø 340	600x610x850 H 65,5 kg	PREMIUM 50 HR
		6,65 kW	 500x500	 530x325x25 H	PREMIUM 50 HR DA
		--			
		230 V 3 50 Hz			
		6,65 kW			
		--			
		230 V 50 Hz			
		6,65 kW			
		--			
		HR:			
		Cold			
		water supply			

Model	Voltage	Capacity	Dimensions	Code
PREMIUM 50 H+ ELECTRONIC 10 PROGRAMS - HR: HEAT RECOVERY				
 <p>A₀=60 HYGIENE +</p> <p>RACK EQUIPMENT</p> <p>1 X C40 1 X C44 1 X 15060</p> 	Multivoltage			PREMIUM 50 H+
	standard 400 V 3N 50 Hz 6,65 kW	 340 H	600x610x850 H 65,5 kg	PREMIUM 50 DA H+
	-- 230 V 3 50 Hz 6,65 kW	 Ø 340	 GN 1/1	PREMIUM 50 HR H+
	-- 230 V 50 Hz 6,65 kW -- HR: Cold water supply	 500x500	530x325x25 H	PREMIUM 50 HR DA H+

A₀=60 Special programs complying with A₀=60 on the scale of thermo-disinfection according to the norm EN ISO 15883-1. All our Hygiene+ models reach the A₀ 60 level defining the minimum reduction level of pathogenic microorganisms and bacterial load. In addition, our Plus Rinsing System guarantees a perfect rinse with steady temperature and water pressure for optional hygienic results

X With special basket to be ordered

HR Heat recover

OPTIONS

Model	220-240 V 50 Hz	380-415 V 3N 50 Hz	220-240 V 3 50 Hz	60 Hz	RO Osmosis connection	PS Drain pump	DDE Detergent dispenser	ST Soft start	DBE Peristaltic rinse-aid disp.
PREMIUM 40	●	M	M	€	□	●	●	●	●
PREMIUM 40 DA	●	M	M	€	----	●	●	●	●
PREMIUM 40 HR	●	M	M	€	□	●	●	●	●
PREMIUM 40 HR DA	●	M	M	€	----	●	●	●	●
PREMIUM 50 SMALL	M	●	M	€	□	●	●	●	●
PREMIUM 50 SMALL DA	M	●	M	€	----	●	●	●	●
PREMIUM 50 HR SMALL	M	●	M	€	□	●	●	●	●
PREMIUM 50 HR SMALL DA	M	●	M	€	----	●	●	●	●
PREMIUM 50	M	●	M	€	□	●	●	●	●
PREMIUM 50 DA	M	●	M	€	----	●	●	●	●
PREMIUM 50 HR	M	●	M	€	□	●	●	●	●
PREMIUM 50 HR DA	M	●	M	€	----	●	●	●	●
PREMIUM 50 H+	M	●	M	€	□	●	●	●	●
PREMIUM 50 DA H+	M	●	M	€	----	●	●	●	●
PREMIUM 50 HR H+	M	●	M	€	□	●	●	●	●
PREMIUM 50 HR DA H+	M	●	M	€	----	●	●	●	●

DA Built-in water softener with automatic regeneration

HR In case of osmotic water supply, it is suggested to feed the machine with electrical conductivity of more than 200 microsiemens
In case of cold water supply for rinse (8-15 °C), the heat recovery option is mandatory

M Multivoltage

● Standard

---- Not available

□ Upon request









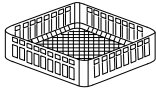

	FS	CR	TS	CONNECTIVITY	BT	WRAS	DVGW	PAP	FLOAT
Model	Cold rinse	Round basket	thermostop system	Connectivity (HACCP)	Break tank	WRAS	DVGW	Rinse pump	Probes lack det. and rinse aid
PREMIUM 40	€	€	●	€	●	€	€	●	€
PREMIUM 40 DA	----	€	●	€	----	----	----	●	€
PREMIUM 40 HR	----	€	●	€	●	----	----	●	€
PREMIUM 40 HR DA	----	€	●	€	----	----	----	●	€
PREMIUM 50 SMALL	€	----	●	€	●	€	€	●	€
PREMIUM 50 SMALL DA	----	----	●	€	----	----	----	●	€
PREMIUM 50 HR SMALL	----	----	●	€	●	----	----	●	€
PREMIUM 50 HR SMALL DA	----	----	●	€	----	----	----	●	€
PREMIUM 50	€	----	●	€	●	€	€	●	€
PREMIUM 50 DA	----	----	●	€	----	----	----	●	€
PREMIUM 50 HR	----	----	●	€	●	----	----	●	€
PREMIUM 50 HR DA	----	----	●	€	----	----	----	●	€
PREMIUM 50 H+	€	----	●	€	●	€	€	●	€
PREMIUM 50 DA H+	----	----	●	€	----	----	----	●	€
PREMIUM 50 HR H+	----	----	●	€	●	----	----	●	€
PREMIUM 50 HR DA H+	----	----	●	€	----	----	----	●	€

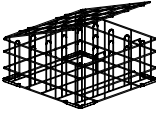

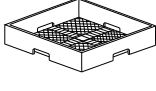
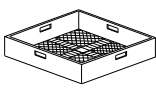
- SOFT START** Progressive start of the wash pump
- WRAS - DVGW** Not available with FS
- DVGW** Components prescribed by DVGW on request (check option compatibility with the manufacturer)
- CONNECTIVITY** Includes HACCP option. 10 year plan
- 380-415 V 3N 50 HZ
220-240 V 3 50 HZ** For the models PREMIUM 40 "upon request" provide extra power
- H+ (HYGIENE+)** 2 cycles of 630 and 180 seconds with high temperatures, reaching up to 75 °C for washing and 90°C for rinsing

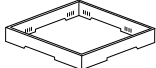
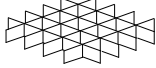
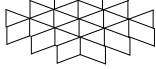
Option compatibility to be confirmed by the manufacturer after verification

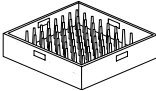
Water supply 55 °C (not on HR version)

EAC label upon request

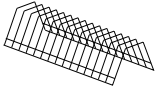
	Description	Capacity	Dimensions	Code
	GLASS BASKET		400x400x135 H	C 121
	SLOPED GLASS BASKET	Ø 100 max	500x500x200 H	C 26
	REUSABLE CUP BASKET	5x5 Glass 30 < Ø < 90 mm H max 185 mm	500x500x235 H	C 135 
	SLOPED GLASS BASKET	Ø 90 max Ø 120 max	400x400x185 H 400x400x160 H	C 123 C 79
	NARROW MESH CUTLERY BASKET		500x500x106 H	C 41
	LARGE MESH BASKET	For glasses	500x500x105 H	C 44
	ROUND GLASS BASKET	Basket	Ø 390x170 H	C 145
	ROUND BASKET SUPPORT	Support	400x400	C 143
	HOLDER FOR GLASS SUPPORT	For glass support (C112-C113-C114)	500x500x50 H	C 111
	GLASS SUPPORT	5x5 Glass Ø 87 mm (C111)	500x500x50 H	C 112
	GLASS SUPPORT	4x4 Glass Ø 110 mm (C111)	500x500x50 H	C 113
	GLASS SUPPORT	6x6 Glass Ø 72 mm (C111)	500x500x50 H	C 114
	PLATE BASKET	18 plates	500x500x105 H	C 40
	PLATE BASKET	12 plates	400x400x120 H	C 31

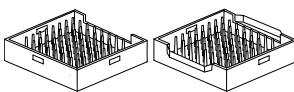
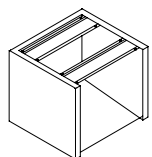
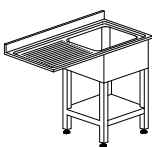
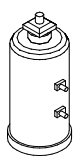
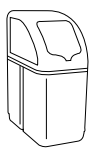
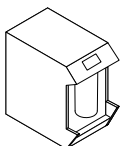
	Description	Capacity	Dimensions	Code	
	SAUCER HOLDER	14 saucers	300x100x90 H	10728	
	CUTLERY BASKET		110x110x120 H	15060	
	GASTRONORM TRAYS BASKET	6 pcs, max. depth 25 mm	500x500x105 H 500x500x105 H	C 43 C 43/B	
	SUPPORT	Stainless steel stand for undercounter 500 x 500	592x535x500 H	999900517	
	SINK UNIT FOR UNDER-COUNTER MODELS	Sink 500x400x300H	1200x700x850 H	K 5/20 *	
	WATER SOFTENER	12 l	Ø 200x500 H	DEP 12	
	AUTOMATIC WATER SOFTENER	12 l (max 800 l)	315x510x685 H	DEP 12-AUT	
	OSMOSIS FOR ALL PREMIUM MODELS	230 V 50 Hz - 250 W 5° C - 35° C Flow rate 240 l/h Not suitable for machine with integrated water softener Special basket dotation	226x522x452 H 20 Kg	K OS240 +	

* Wooden cage +2% minimum + €
Special dimensions for tables upon request
Tables shown in right-to-left version

HOOD 70

ROBUST AND ESSENTIAL
HOOD-TYPE DISHWASHERS



You asked and we listened! We are thrilled to announce our brand new range HOOD 70. These robust and essential hood-type dishwashers simply make sense. Nothing superfluous: solid S/S body

with single skin hood, sloped tank, innovative and light arms, controlled temperatures and, only if needed, detergent dispenser and drain pump. Wash, rinse, restart. It is really that simple.



ELECTRONIC VERSION





The intuitive LED control panel of the HOOD 70 L model will display if the correct temperatures of both tank and boiler have been reached. You can choose among 3 different wash programs to perfectly tailor the performances of the machine to the crockery that needs to be cleaned.

FEATURES

- 1 wash cycle (HOOD 70)
- 3 wash cycles (HOOD 70 L)
- Self-cleaning cycle on the electronic version (HOOD 70 L)
- Tank and boiler thermometers
- Hood operating start/stop functions
- Deep-formed tank
- Innovative system of coupled wash and rinse arms in polypropylene and fiber of glass
- Standard surface filters in polypropylene
- Pump filter
- Standard rinse aid dispenser
- Easily removable basket support
- Linear or corner layouts

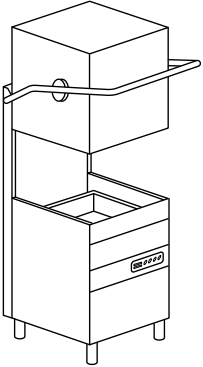





HOOD 70

ROBUST AND ESSENTIAL
HOOD-TYPE DISHWASHERS

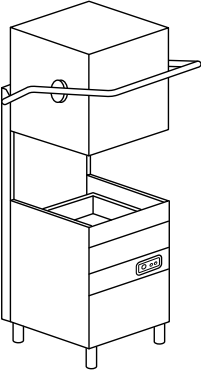
Model	Voltage	Capacity	Dimensions	Code
HOOD 70 1 PROGRAM 	400 V 3N ~ 50 Hz 6,55 kW	 355 H  Ø 410  500x500	720x735x 1445/1880 H 100 kg  530x325x25 H	HOOD 70

RACK
EQUIPMENT
1 X C40
1 X C44
1 X 15060

X With special basket to be ordered

Model	Voltage	Capacity	Dimensions	Code
HOOD 70 L 3 PROGRAMS 	400 V 3N ~ 50 Hz 6,55 kW	 355 H  Ø 410  500x500	720x735x 1445/1880 H 100 kg  530x325x25 H	HOOD 70 L
<div style="border: 1px solid black; padding: 5px;"> <p>RACK EQUIPMENT</p> <p>1 X C40 1 X C44 1 X 15060</p>  </div>				





OPTIONS

		PS	DDE	DB	TS	DF
Model	380-415 V 3N 50 Hz	Drain pump	Detergent dispenser	Rinse-Aid dispenser	Thermostop system	Surface filters kit
HOOD 70	●	€	€	●	●	●
HOOD 70 L	●	€	€	●	●	●

- Standard
- Not available
- L LED electronic

EAC label upon request

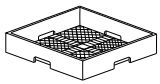
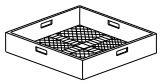
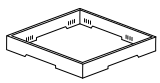
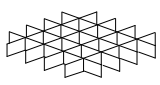
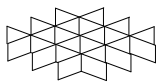
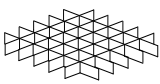
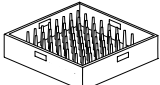
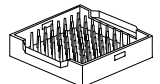
Water supply 55 °C. Water hardness min 2°f - max 8°f (if higher, an external water softener is required)

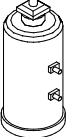
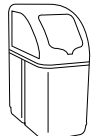
	Description	Capacity	Dimensions	Code
	SLOPED GLASS BASKET	Ø 100 max	500x500x200 H	C 26
	REUSABLE CUP BASKET	5x5 Glass 30 < Ø < 90 mm H max 185 mm	500x500x235 H	C 135 
	NARROW MESH CUTLERY BASKET		500x500x106 H	C 41
	LARGE MESH BASKET	For glasses	500x500x105 H	C 44
	HOLDER FOR GLASS SUPPORT	For glass support (C112-C113-C114)	500x500x50 H	C 111
	GLASS SUPPORT	5x5 Glass Ø 87 mm (C111)	500x500x50 H	C 112
	GLASS SUPPORT	4x4 Glass Ø 110 mm (c111)	500x500x50 H	C 113
	GLASS SUPPORT	6x6 Glass Ø 72 mm (C111)	500x500x50 H	C 114
	PLATE BASKET	18 plates	500x500x105 H	C 40
	GASTRONORM TRAYS BASKET	6 pcs, max. depth 25 mm	500x500x105 H	C 43/B
	CUTLERY BASKET	Standard (2 pcs)	110x110x120 H	15060
	WATER SOFTENER	12 l	Ø 200x500 H	DEP 12
	AUTOMATIC WATER SOFTENER	12 l (max 800)	315x510x685 H	DEP 12-AUT

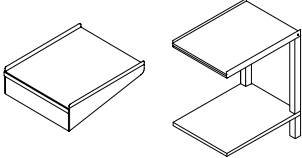
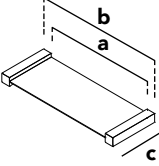
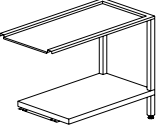
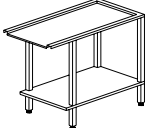
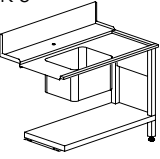
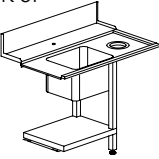
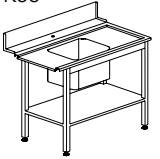
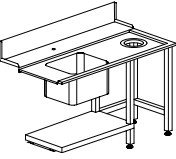
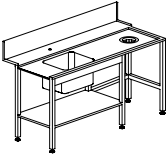
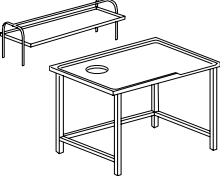
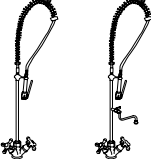
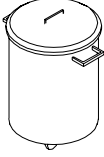
	Description	Capacity	Dimensions	Code
	SHELF TABLE	Only for exit	600x510 650x510x860 H	K 2ME K 4/65
	HOOD CONNECTION SHELF		a: 510 b: 590 c: 239	KIT DUO
K 4/70 B - K 4/120 B  K 4B 		TABLE	700x590x860 H 1200x590x860 H 1200x590x860 H	K 4/70B K 4/120B K 4B
K 5  K 5F  K55 		Sink 500x400x270 H	1200x730x860 H 1200x730x860 H 1200x730x860 H	K 5 K 5F K 55
K 8E  K 8 - K 9 		Sink 500x400x270 H	1500x730x860 H 1500x730x860 H 1800x730x860 H	K 8 K 8E K 9
	SHELF		1515x620x660 H 2315x620x660 H	K 7M16 * K 7M24 *
	GRADING TABLE WITH RUBBER RING AND HOLE	Special dimensions upon request	1600x1000x850 H 2400x1000x850 H	K 7A/1600 * K 7A/2400 *
	FLEXIBLE SHOWER complete with mixing group and lever tap, to be fixed to the wall		1000 H	K 1
	FLEXIBLE SHOWER complete with mixing group and lever tap, to be fixed to the wall and intermediate tap		1000 H	K 1HR
	STAINLESS STEEL WASTE BIN	Basic model	Ø 400x570 H	K 7/1
		With wheels	Ø 400x570 H	K 7/2
		With wheels and pedal board	Ø 400x570 H	K 7/3

* Wooden cage +2% minimum + €
Special dimensions for tables upon request
Tables shown in right-to-left version

HOOD 110

SINGLE SKIN HOOD-TYPE
DISHWASHERS



The KROMO hood-type dishwashers offer a wide range of models, from the ones that can be equipped with the most advanced options, to the most innovative types, designed with avant-garde electronics and with all options included. Our products have evolved together with our experience and our customers' hints and insights. Therefore we are able

to produce tailor-made models that fulfil our final customers' criteria of functionality, reliability and versatility.

Our aim is to reduce consumptions in terms of energy, water and chemical products, therefore granting the final user global savings, but also less pollution and waste of natural resources.



TOUCH PANEL

The LED panel displays the temperatures of both tank and boiler, the wash cycle and status and eventual main alarm codes for malfunctions. There are four wash cycles available. These innovations are designed to provide KROMO's customers with even more user friendly machines, maintaining the same high performances. The soft start function grants extra protection for fragile objects.

FEATURES HOOD 80 / HOOD 110







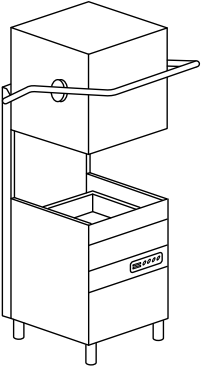

- Two wash cycles
- Hood operating start/stop functions
- Tank deep-formed bottom
- Pump filter
- Built-in rinse-aid pump
- Tank and boiler thermometres
- Easily removable basket support
- Linear or corner layouts
- Innovative system of coupled wash and rinse arms in polypropylene and fiber of glass (HOOD 80)
- Independent stainless steel wash arms and polypropylene and fiber of glass rinse arms (HOOD 110)
- Surface filters in polypropylene (HOOD 80)
- S/S surface filters (HOOD 110)
- Built-in water softener available on and recommended for water > 8°f; max 35°f

FEATURES HOOD 80 T / HOOD 110 T



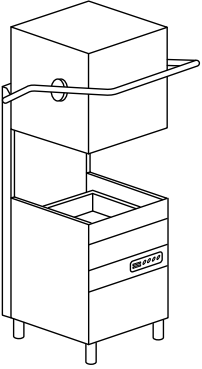

- Easy and intuitive LED control panel
- Four wash cycles
- Hood operating start/stop functions
- Tank deep-formed bottom
- Built-in rinse-aid pump
- Tank and boiler thermometres
- Surface filters
- Easily removable basket support
- Linear or corner layouts
- Self-cleaning cycle
- Soft Start wash pump
- Innovative system of coupled wash and rinse arms in polypropylene and fiber of glass (HOOD 80 T)
- Independent stainless steel wash arms and polypropylene and fiber of glass rinse arms (HOOD 110 T)
- Surface filters in polypropylene (HOOD 80 T)
- S/S surface filters (HOOD 110 T)
- D: Built-in water softener recommended for water > 8°f; max 35°f

HOOD 110

SINGLE SKIN HOOD-TYPE
DISHWASHERS

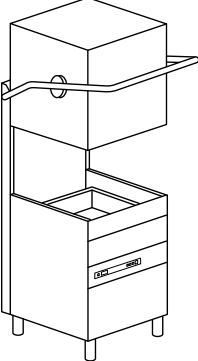
Model	Voltage	Capacity	Dimensions	Code
HOOD 80 2 PROGRAMS 	400 V 3N ~ 50 Hz 6,9 kW	 Ø 410  500x500	720x735x 1445/1880 H 100 kg  530x325x25 H	HOOD 80
HOOD 110 2 PROGRAMS 	400 V 3N ~ 50 Hz 10,2 kW	 Ø 410  500x500	720x735x 1445/1880 H 100 kg  530x325x25 H	HOOD 110 HOOD 110 D

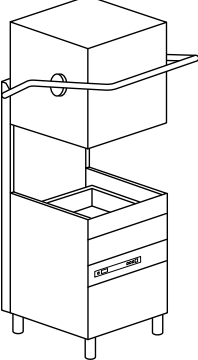
X With special basket to be ordered

Model	Voltage	Capacity	Dimensions	Code
HOOD 80 T ELECTRONIC 4 PROGRAMS				
	<p>RACK EQUIPMENT 2 X C40 1 X C44 2 X 15060</p> 	<p>400 V 3N ~ 50 Hz 6,9 kW</p>	<p>Ø 410</p>  500x500	<p>720x735x 1445/1880 H 100 kg</p> <p>HOOD 80 T</p>
				<p>GN 1/1</p> <p>530x325x25 H</p> <p>HOOD 80 T DA</p>
HOOD 110 T ELECTRONIC 4 PROGRAMS				
	<p>RACK EQUIPMENT 2 X C40 1 X C44 2 X 15060</p> 	<p>400 V 3N ~ 50 Hz 10,2 kW</p>	<p>Ø 410</p>  500x500	<p>720x735x 1445/1880 H 100 kg</p> <p>HOOD 110 T</p>
				<p>GN 1/1</p> <p>530x325x25 H</p> <p>HOOD 110 T DA</p>

HOOD 110

SINGLE SKIN HOOD-TYPE
DISHWASHERS

OPTIONS

					XP	PS	DDE
Model	220-240 V 50 Hz	380-415 V 3N 50 Hz	220-240 V 3 50 Hz	60 Hz	Extra power	Drain pump	Detergent dispenser
HOOD 80	€	●	□	€	€	€	€
HOOD 110	€	●	□	€	€	€	€
HOOD 110 D	€	●	□	€	€	€	€
HOOD 80 T	€	●	□	€	€	€	€
HOOD 80 T DA	€	●	□	€	€	€	€
HOOD 110 T	€	●	□	€	€	€	€
HOOD 110 T DA	€	●	□	€	€	€	€

- Standard
- Upon request
- Not available
- D** Built-in water softener
- DA** Built-in water softener with automatic regeneration
- T** LED Electronic (Soft Touch)
- * Construction according to UL-NSF standards upon request

EAC label upon request

Water supply 55 °C

	DB	DBE	TS	ST	BT	WRAS	DVGW	PAP	DF
Model	Rinse-aid dispenser	Peristaltic rinse-aid disp.	Thermostop system	Soft start	Break tank	WRAS	DVGW	Booster pump	Surface filters kit
HOOD 80	●	€	●	----	€	€	€	€	●
HOOD 110	●	€	●	----	€	€	€	€	●
HOOD 110 D	●	€	●	----	----	----	----	€	●
HOOD 80 T	●	€	●	●	€	€	€	€	●
HOOD 80 T DA	●	€	●	●	----	----	----	€	●
HOOD 110 T	●	€	●	●	€	€	€	€	●
HOOD 110 T DA	●	€	●	●	----	----	----	€	●





230-240 V 50 HZ For HOOD 110 total power 7,2 kW upon request

XP In case of cold water supply for rinse 8 °C 55 °C, and without any heat recovery, the extra power option is mandatory. + 3000 W with standard voltage only, for further voltage information, please contact us. In case of cold water supply for rinse 8-15 °C, We recommend the heat recovery option, if available on the selected model

BT - WRAS - DVGW Booster pump included

DVGW Components prescribed by DVGW on request (check option compatibility with the manufacturer)

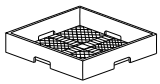
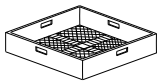
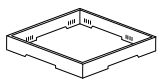
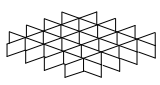
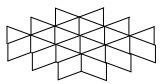
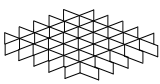
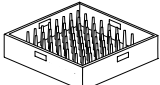
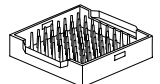
Option compatibility to be confirmed by the manufacturer after verification

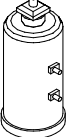
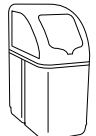
	Description	Capacity	Dimensions	Code
	SLOPED GLASS BASKET	Ø 100 max	500x500x200 H	C 26
	REUSABLE CUP BASKET	5x5 Glass 30 < Ø < 90 mm H max 185 mm	500x500x235 H	C 135 
	NARROW MESH CUTLERY BASKET		500x500x106 H	C 41
	LARGE MESH BASKET	For glasses	500x500x105 H	C 44
	HOLDER FOR GLASS SUPPORT	For glass support (C112-C113-C114)	500x500x50 H	C 111
	GLASS SUPPORT	5x5 Glass Ø 87 mm (C111)	500x500x50 H	C 112
	GLASS SUPPORT	4x4 Glass Ø 110 mm (C111)	500x500x50 H	C 113
	GLASS SUPPORT	6x6 Glass Ø 72 mm (C111)	500x500x50 H	C 114
	PLATE BASKET	18 plates	500x500x105 H	C 40
	GASTRONORM TRAYS BASKET	6 pcs, max. depth 25 mm	500x500x105 H	C 43/B
	CUTLERY BASKET		110x110x120 H	15060
	WATER SOFTENER	12 l	Ø 200x500 H	DEP 12
	AUTOMATIC WATER SOFTENER	12 l (max 800 l)	315x510x685 H	DEP 12-AUT

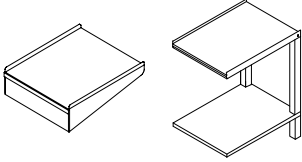
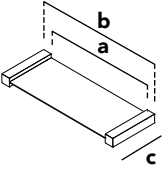
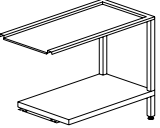
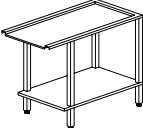
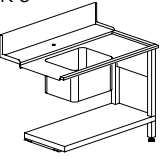
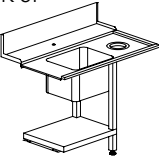
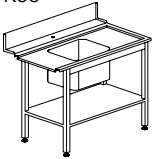
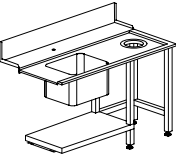
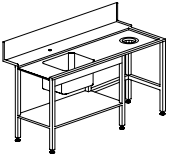
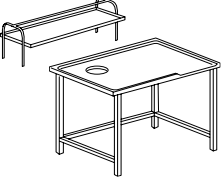
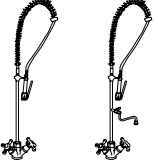
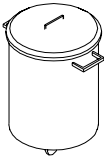
	Description	Capacity	Dimensions	Code
	SHELF TABLE	Only for exit	600x510 650x510x860 H	K 2ME K 4/65
	HOOD CONNECTION SHELF		a: 510 b: 590 c: 239	KIT DUO
K 4/70 B - K 4/120 B  K 4B 		TABLE	700x590x860 H 1200x590x860 H 1200x590x860 H	K 4/70B K 4/120B K 4B
K 5  K 5F  K 55 		Sink 500x400x270 H	1200x730x860 H 1200x730x860 H 1200x730x860 H	K 5 K 5F K 55
K 8E  K 8 - K 9 		Sink 500x400x270 H	1500x730x860 H 1500x730x860 H 1800x730x860 H	K 8 K 8E K 9
	SHELF		1515x620x660 H 2315x620x660 H	K 7M16 * K 7M24 *
	GRADING TABLE WITH RUBBER RING AND HOLE	Special dimensions upon request	1600x1000x850 H 2400x1000x850 H	K 7A/1600 * K 7A/2400 *
	FLEXIBLE SHOWER complete with mixing group and lever tap, to be fixed to the wall		1000 H	K 1
	FLEXIBLE SHOWER complete with mixing group and lever tap, to be fixed to the wall and intermediate tap		1000 H	K 1HR
	STAINLESS STEEL WASTE BIN	Basic model	Ø 400x570 H	K 7/1
		With wheels	Ø 400x570 H	K 7/2
		With wheels and pedal board	Ø 400x570 H	K 7/3

* Wooden cage +2% minimum + €
Special dimensions for tables upon request
Tables shown in right-to-left version

HOOD 110 I

INSULATED
HOOD-TYPE DISHWASHERS



The KROMO hood-type dishwashers offer a wide range of models, from the ones that can be equipped with the most advanced options, to the most innovative types, designed with avant-garde electronics and with all options included. Our products have evolved together with our experience and our customers' hints and insights. Therefore we are able to produce tailor-made models that fulfil our final customers' criteria of functionality, reliability and ver-

satility. Our aim is to reduce consumptions in terms of energy, water and chemical products, therefore granting the final user global savings, but also less pollution and waste of natural resources. This comprehensive range expands with a new Thermolabel model, designed to ensure efficiency and consistently excellent washing results. It's the perfect choice for professional kitchens that require consistent, uncompromising performance.



TOUCH PANEL

The LED panel displays the temperatures of both tank and boiler, the wash cycle and status and eventual main alarm codes for malfunctions. There are four wash cycles available. These innovations are designed to provide KROMO's customers with even more user friendly machines, maintaining the same high performances. The soft start function grants extra protection for fragile objects.

THERMOLABEL 🌿

When hygiene needs to be proven, promises aren't enough: documented results are essential. The HOOD 110 I TT meets the requirements of the Thermolabel test, confirming the washing cycle's actual disinfection effectiveness. The Thermolabel test system guarantees a temperature of 71°C reached and maintained on the surface of the plates, thus delivering excellent hygiene results and guaranteed compliance with HACCP standards. Powerful, reliable and designed for demanding environments, it is the ideal choice for professional kitchens in hotel groups, airline catering, and commercial and institutional food service that cannot afford downtime."

FEATURES HOOD 110 I





- Two wash cycles
- Hood operating start/stop functions
- Tank deep-formed bottom
- Pump filter
- S/S surface filters
- Double skin insulated hood
- Built-in rinse-aid pump
- Tank and boiler thermometres
- Easily removable basket support
- Linear or corner layouts
- Independent stainless steel wash arms and polypropylene and fiber of glass rinse arms
- Built-in water softener available and recommended for water > 8°f; max 35°f

FEATURES HOOD 110 I T



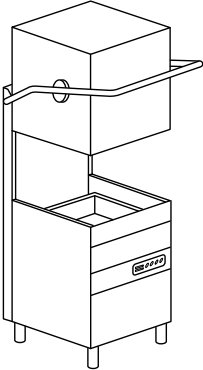

- Easy and intuitive LED control panel
- Four wash cycles
- Hood operating start/stop functions
- Tank deep-formed bottom
- Built-in rinse-aid pump
- Tank and boiler thermometres
- Surface filters
- Easily removable basket support
- Double skin insulated hood
- Linear or corner layouts
- Independent stainless steel wash arms and polypropylene and fiber of glass rinse arms
- Soft Start wash pump
- Self-cleaning cycle
- Built-in water softener available and recommended for water > 8°f; max 35°f

HOOD 110 I

INSULATED
HOOD-TYPE DISHWASHERS

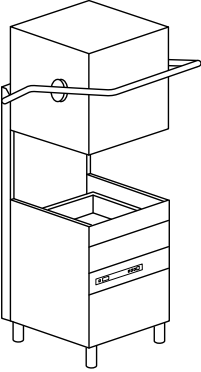



Model	Voltage	Capacity	Dimensions	Code
HOOD 110 I 2 PROGRAMS				
	<p>RACK EQUIPMENT 2 X C40 1 X C44 2 X 15060</p> 	<p>400 V 3N ~ 50 Hz 10,2 kW</p>	 <p>ø 410</p>  <p>500x500</p>	<p>720x735x 1445/1880 H 100 kg</p> <p>HOOD 110 I</p>
				<p>GN 1/1 ^X</p> <p>530x325x25 H</p> <p>HOOD 110 I D</p>

X With special basket to be ordered

Model	Voltage	Capacity	Dimensions	Code
HOOD 110 I T ELECTRONIC 4 PROGRAMS				
 <div data-bbox="352 450 528 636" style="border: 1px solid black; padding: 5px; margin-top: 10px;"> <p>RACK EQUIPMENT</p> <p>2 X C40 1 X C44 2 X 15060</p> </div>	<p>400 V 3N ~ 50 Hz 10,2 kW</p>	 <p>ø 410</p>  <p>500x500</p>	<p>720x735x 1445/1880 H 100 kg</p>	HOOD 110 I T
			 <p>530x325x25 H</p>	HOOD 110 I T DA

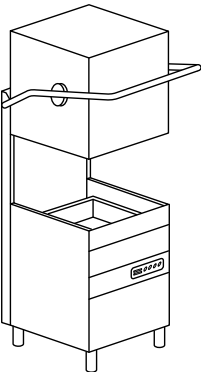
HOOD 110 I TT

 THERMOLABEL INSULATED
HOOD-TYPE DISHWASHERS



Model	Voltage	Capacity	Dimensions	Code
HOOD 110 I TT ELECTRONIC 4 PROGRAMS				
 <div data-bbox="352 1330 528 1516" style="border: 1px solid black; padding: 5px; margin-top: 10px;"> <p>RACK EQUIPMENT</p> <p>2 X C40 1 X C44 2 X 15060</p> </div>	<p>400 V 3N ~ 50 Hz 10,2 kW</p>	 <p>ø 410</p>  <p>500x500</p>	<p>720x735x 1445/1880 H 100 kg</p>	HOOD 110 I TT
			 <p>530x325x25 H</p>	HOOD 110 I TT DA

X With special basket to be ordered

HOOD 110 I

INSULATED
HOOD-TYPE DISHWASHERS

OPTIONS

					XP	PS	DDE	DB	DBE
Model	220-240 V 50 Hz	380-415 V 3N 50 Hz	220-240 V 3 50 Hz	60 Hz	Extra power	Drain pump	Detergent dispenser	Rinse-aid dispenser	Peristaltic rinse-aid disp.
HOOD 110 I	€	●	□	€	€	€	€	●	€
HOOD 110 I D	€	●	□	€	€	€	€	●	€
HOOD 110 I T	€	●	□	€	€	€	€	●	€
HOOD 110 I T DA	€	●	□	€	€	€	€	●	€
HOOD 110 I TT 	€	●	□	€	€	€	€	●	€
HOOD 110 I TT DA 	€	●	□	€	€	€	€	●	€

● Standard

□ Upon request

---- Not available

I Insulated hood

D Built-in water softener



DA Built-in water softener with automatic regeneration

 **THERMOLABEL:** Machine that meets the Thermolabel test requirements, confirming the wash cycle's effective sanitization performance. The Thermolabel is a testing system that ensures a temperature of 71°C is reached and maintained on the plate surface, ensuring excellent hygiene results and guaranteed compliance with HACCP standards.

T LED Electronic (Soft Touch)

EAC label upon request

Water supply 55 °C

	TS	ST	BT	WRAS	DVGW	PAP	ID	DF
Model	Thermostop system	Soft start	Break tank	WRAS	DVGW	Booster pump	Double skin	Surface filters kit
HOOD 110 I	●	----	€	€	€	€	●	●
HOOD 110 I D	●	----	----	----	----	€	●	●
HOOD 110 I T	●	●	€	€	€	€	●	●
HOOD 110 I T DA	●	●	----	----	----	€	●	●
HOOD 110 I TT 	●	●	€	€	€	€	●	●
HOOD 110 I TT DA 	●	●	----	----	----	€	●	●





220-240 V 50 HZ For HOOD 110 I total power 7,2 kW upon request

XP In case of cold water supply for rinse 8 °C - 55 °C, and without any heat recovery, the extra power option is mandatory. + 3000 W with standard voltage only, for further voltage information, please contact us. In case of cold water rinse supply (8-15 °C), is recommended heat recovery option (available on the selected models)

BT - WRAS - DVGW Booster pump included

DVGW Components prescribed by DVGW on request (check option compatibility with the manufacturer)

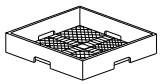
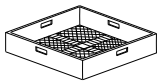
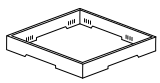
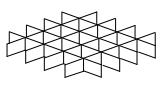
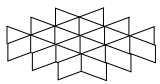
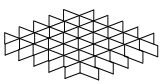
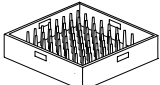
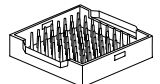
Option compatibility to be confirmed by the manufacturer after verification

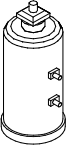
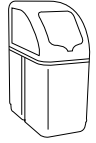
	Description	Capacity	Dimensions	Code
	SLOPED GLASS BASKET	Ø 100 max	500x500x200 H	C 26
	REUSABLE CUP BASKET	5x5 Glass 30 < Ø < 90 mm H max 185 mm	500x500x235 H	C 135 
	NARROW MESH CUTLERY BASKET		500x500x106 H	C 41
	LARGE MESH BASKET	For glasses	500x500x105 H	C 44
	HOLDER FOR GLASS SUPPORT	For glass support (C112-C113-C114)	500x500x50 H	C 111
	GLASS SUPPORT	5x5 Glass Ø 87 mm (C111)	500x500x50 H	C 112
	GLASS SUPPORT	4x4 Glass Ø 110 mm (C111)	500x500x50 H	C 113
	GLASS SUPPORT	6x6 Glass Ø 72 mm (C111)	500x500x50 H	C 114
	PLATE BASKET	18 plates	500x500x105 H	C 40
	GASTRONORM TRAYS BASKET	6 pcs, max. depth 25 mm	500x500x105 H	C 43/B
	CUTLERY BASKET		110x110x120 H	15060
	WATER SOFTENER	12 l	Ø 200x500 H	DEP 12
	AUTOMATIC WATER SOFTENER	12 l (max 800 l)	315x510x685 H	DEP 12-AUT

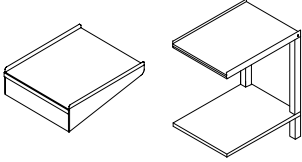
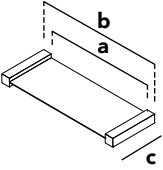
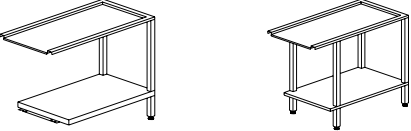
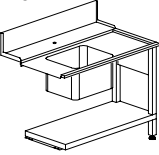
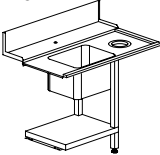
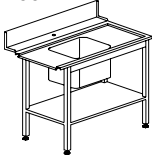
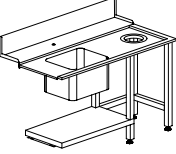
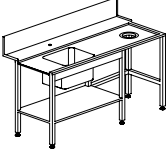
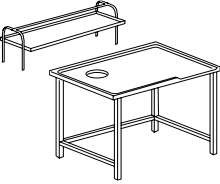
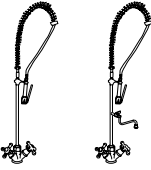
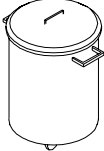
	Description	Capacity	Dimensions	Code	
	SHELF TABLE	Only for exit	600x510 650x510x860 H	K 2ME K 4/65	
	HOOD CONNECTION SHELF		a: 510 b: 590 c: 239	KIT DUO	
K 4/70 B - K 4/120 B 	K 4B TABLE		700x590x860 H 1200x590x860 H 1200x590x860 H	K 4/70B K 4/120B K 4B	
K 5 	K 5F 	K55 	Sink 500x400x270 H	1200x730x860 H 1200x730x860 H 1200x730x860 H	K 5 K 5F K 55
K 8 E 	K 8 - K 9 		Sink 500x400x270 H	1500x730x860 H 1500x730x860 H 1800x730x860 H	K 8 K 8E K 9
	SHELF GRADING TABLE WITH RUBBER RING AND HOLE	Special dimensions upon request	1515x620x660 H 2315x620x660 H 1600x1000x850 H 2400x1000x850 H	K 7M16 * K 7M24 * K 7A/1600 * K 7A/2400 *	
	FLEXIBLE SHOWER complete with mixing group and lever tap, to be fixed to the wall FLEXIBLE SHOWER complete with mixing group and lever tap, to be fixed to the wall and intermediate tap		1000 H 1000 H	K 1 K 1HR	
	STAINLESS STEEL WASTE BIN	Basic model With wheels With wheels and pedal board	Ø 400x570 H Ø 400x570 H Ø 400x570 H	K 7/1 K 7/2 K 7/3	

* Wooden cage +2% minimum + €
Special dimensions for tables upon request
Tables shown in right-to-left version

HOOD 130 LUX

LATEST GENERATION
HOOD-TYPE DISHWASHERS



The latest generation KROMO hoodtype dishwashers. These machines are built with fully double-skin hoodtype, designed for being silent and reliable. Beside the standard electronic version with four programmable cycles, we have developed the PLUS models with guaranteed steady rinse temperature and pressure and two cycles with HYGIENE+

superior features ($A_0=30$ on the scale of thermo-disinfection according to the norm EN ISO 15883-1). Thanks to these latest technological features, the sturdy PLUS versions will promote the almost total elimination of the bacterial load. The customization of our new generation machines has never been so easy!

A₀=30
HYGIENE +

HYGIENE+ SYSTEM

The HYGIENE+ models perform long cycles at high temperatures to fulfill high levels of hygiene, now more essential than ever for our health. These special programs comply with A₀=30 on the scale of thermo-disinfection according to the norm EN ISO 15883-1.

The HYGIENE+ models include 2 special cycles, a short one of 180 seconds and a longer one of 630 seconds, ensuring compliance with high levels of hygiene thanks to high temperatures and long cycles.



FEATURES

- Easy and intuitive electronic control panel
- Modification of the dosage of detergent and rinse-aid directly on the control panel (PLUS versions)
- Remote control panel available on request instead of the standard control panel (PLUS versions)
- Four customizable programs
- Hygiene + version (H+ models): two special additional programs complying with A₀=30 according to the norm EN ISO 15883-1
- Double skin insulated hood
- Deep tank
- Double tank filters, with dirt collection system and pump filter (improved system for a better filtration of the wash water)
- Self-cleaning vertical washing pump for greater operating hygiene
- Rinse-aid and detergent dispensers included (peristaltic rinse-aid dispenser included on PLUS versions)
- Detergent and rinse-aid dosage setting, directly from the control panel (detergent dispenser only on non-PLUS models)
- Water consumption and working time control system (PLUS versions)
- Easy to access for maintenance
- Anti-drop roof panel
- Easily removable basket support
- Linear or corner layouts
- Self-cleaning cycle
- LIFT: automatic hood lift at the end of cycle
- HR: Heat recovery steam condensing unit for cold water supply (HOOD 130 LUX HR PLUS H+)
- CONNECTIVITY remote control compliant with the HACCP norms (on request)
- Predisposition for connection to an external device of reverse osmosis (on request on PLUS versions)
- D: Built-in water softener recommended for water > 8°f; max 35°f

HOOD 130 LUX

LATEST GENERATION
HOOD-TYPE DISHWASHERS

CONNECTIVITY 4.0 & APP

WHEREVER YOU ARE...
YOUR DISHWASHER, JUST A CLICK AWAY

You will be constantly connected to the machine to monitor the work phases, review any eventual alarm and configure remotely the operating parameters according to your needs. Compliant with HACCP norms. Thanks to our brand new App, you will have access to connected machines and all commercial and technical documentation.

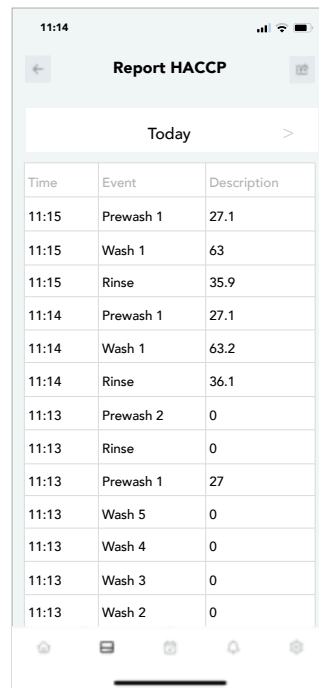
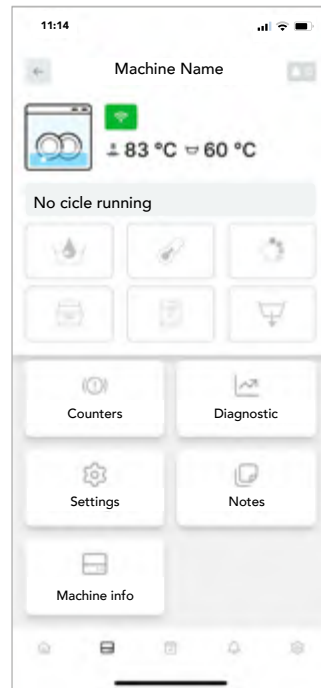

View all the working parameters and event records, working hours and any problem at any time.



In case of problem, the machine promptly alerts you. The technician can intervene remotely to solve the problem or anticipate the needed parts for an on-site intervention.



A daily activity report is available with all the events related to the dishwasher in a detailed spreadsheet with HACCP data.



Our Connectivity system is a revolutionary device limiting and facilitating the eventual intervention of a technician who can anticipate the necessary parts to be replaced, saving time and money.

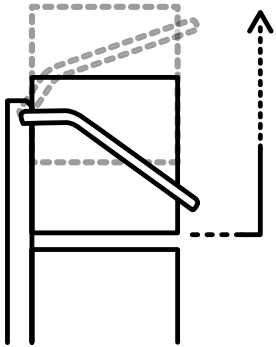

IMPROVED LIFT SYSTEM:

AUTOMATIC TWO-STEP HOOD LIFT AT THE END OF THE CYCLE

The hydraulic system has been replaced by an electric motor. Its simplicity limits maintenance and the formation of limescale. The latter, freeing up space, allows to add more options to the LIFT models such as the integrated automatic softener.

PLUS SYSTEM

GUARANTEED RINSE EVEN WITH LOW PRESSURE OF THE WATER INLET

We have developed an innovative rinsing system at constant temperature, consumption and water pressure, regardless of external conditions. The PLUS System ensures optimal and constant rinsing performance thanks to the combination of Break Tank, atmospheric boiler and rinse pump.

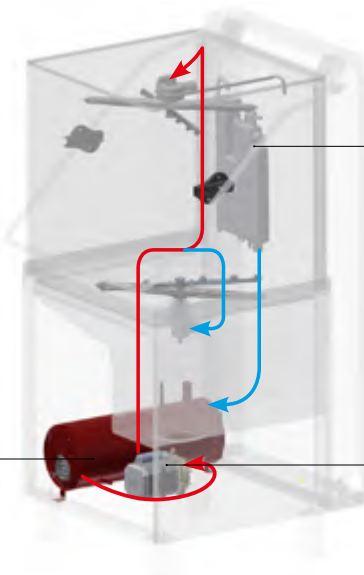

BREAK TANK

The Break Tank system prevents the heated water of the boiler to go back and mix with the fresh water supply.

ATMOSPHERIC BOILER

The water temperature in the boiler remains constant at 85°C throughout the rinse, as the boiler refill only occurs once the rinse cycle is done.

RINSE PUMP

The water is sucked from the boiler through a rinse pump and is sent to the rinse nozzles. The correct pressure is ensured regardless of the water inlet pressure and temperature.





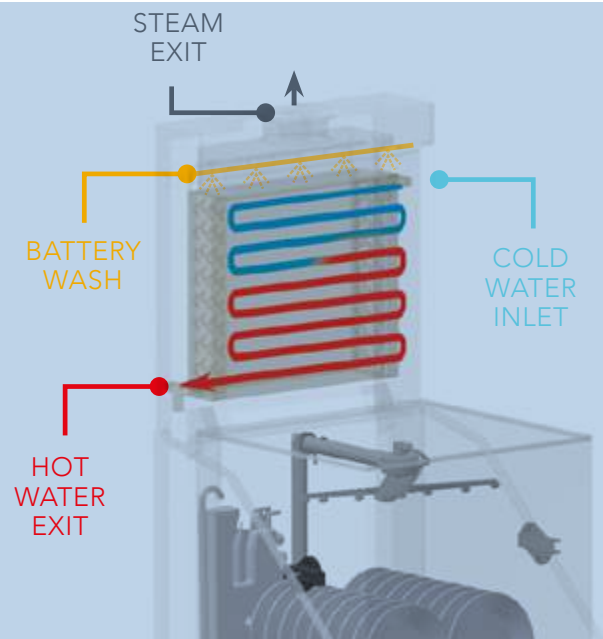





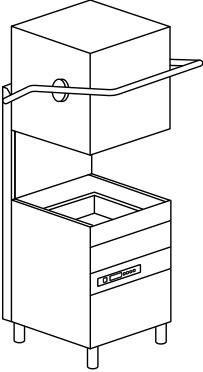



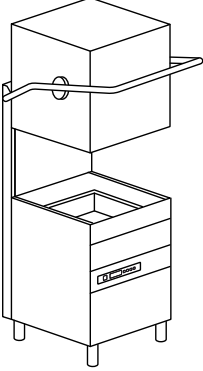

HR - ENERGY RECOVERY

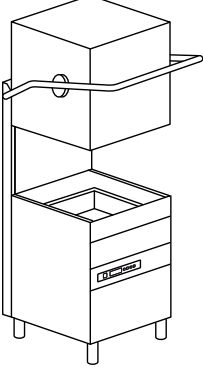



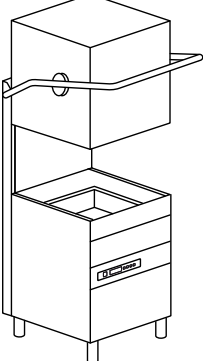





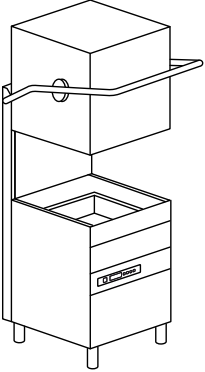



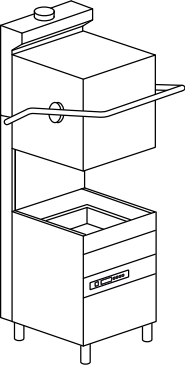

The ENERGY RECOVERY system uses the heat produced by the machine to preheat the inlet cold water (8-15 °C). This is an immediate saving on energy costs. Additionally, an optimal temperature in the dishwashing area is achieved as the air is no more affected by steam and humidity.

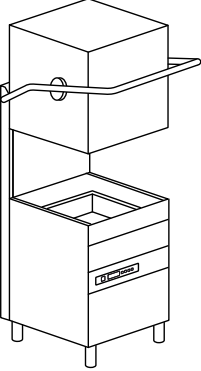

HOOD 130 LUX

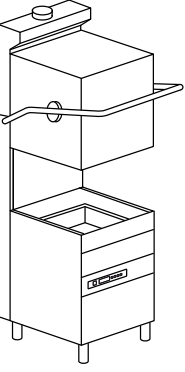
LATEST GENERATION
HOOD-TYPE DISHWASHERS

Model	Voltage	Capacity	Dimensions	Code
HOOD 130 LUX ELECTRONIC 4 PROGRAMS				
 <p>RACK EQUIPMENT 2 X C40 1 X C44 2 X 15060</p>	400 V 3N ~ 50 Hz 10,5 kW	 <p>ø 410</p>  <p>500x500</p>	720x735x 1445/1880 H 115 kg  <p>530x325x25 H</p>	HOOD 130 LUX HOOD 130 LUX DA
HOOD 130 LUX H+ ELECTRONIC 4 PROGRAMS				
 <p>RACK EQUIPMENT 2 X C40 1 X C44 2 X 15060</p>	400 V 3N ~ 50 Hz 10,5 kW	 <p>ø 410</p>  <p>500x500</p>	720x735x 1445/1880 H 115 kg  <p>530x325x25 H</p>	HOOD 130 LUX H+ HOOD 130 LUX DA H+
HOOD 130 LUX LIFT ELECTRONIC 4 PROGRAMS				
 <p>RACK EQUIPMENT 2 X C40 1 X C44 2 X 15060</p>	400 V 3N ~ 50 Hz 10,5 kW	 <p>ø 410</p>  <p>500x500</p>	720x735x 1445/1880 H 119 kg  <p>530x325x25 H</p>	HOOD 130 LUX LIFT HOOD 130 LUX LIFT DA
HOOD 130 LUX LIFT H+ ELECTRONIC 4 PROGRAMS				
 <p>RACK EQUIPMENT 2 X C40 1 X C44 2 X 15060</p>	400 V 3N ~ 50 Hz 10,5 kW	 <p>ø 410</p>  <p>500x500</p>	720x735x 1445/1880 H 119 kg  <p>530x325x25 H</p>	HOOD 130 LUX LIFT H+ HOOD 130 LUX LIFT DA H+

Model	Voltage	Capacity	Dimensions	Code
HOOD 130 LUX PLUS H+ ELECTRONIC 6 PROGRAMS				
 <p>A₀=30 HYGIENE +</p> <p>RACK EQUIPMENT 2 X C40 1 X C44 2 X 15060</p>	400 V 3N ~ 50 Hz 10,5 kW	 ø 410  500x500	720x735x 1445/1880 H 115 kg  530x325x25 H	HOOD 130 LUX PLUS H+ HOOD 130 LUX PLUS DA H+
HOOD 130 LUX HR PLUS H+ ELECTRONIC 6 PROGRAMS - HR: HEAT RECOVERY				
 <p>A₀=30 HYGIENE +</p> <p>RACK EQUIPMENT 2 X C40 1 X C44 2 X 15060</p>	400 V 3N ~ 50 Hz 10,5 kW HR: Cold water supply	 ø 410  500x500	720x735x 2095 H 145 kg  530x325x25 H	HOOD 130 LUX HR PLUS H+ HOOD 130 LUX HR PLUS DA H+
HOOD 130 LUX PLUS LIFT H+ ELECTRONIC 6 PROGRAMS				
 <p>A₀=30 HYGIENE +</p> <p>RACK EQUIPMENT 2 X C40 1 X C44 2 X 15060</p>	400 V 3N ~ 50 Hz 10,5 kW	 ø 410  500x500	720x735x 1445/1880 H 115 kg  530x325x25 H	HOOD 130 LUX PLUS LIFT H+ HOOD 130 LUX PLUS LIFT DA H+
HOOD 130 LUX HR PLUS LIFT H+ ELECTRONIC 6 PROGRAMS - HR: HEAT RECOVERY				
 <p>A₀=30 HYGIENE +</p> <p>RACK EQUIPMENT 2 X C40 1 X C44 2 X 15060</p>	400 V 3N ~ 50 Hz 10,5 kW HR: Cold water supply	 ø 410  500x500	720x735x 2095 H 145 kg  530x325x25 H	HOOD 130 LUX HR PLUS LIFT H+ HOOD 130 LUX HR PLUS LIFT DA H+

HOOD 130 LUX

LATEST GENERATION
HOOD-TYPE DISHWASHERS

OPTIONS

Model	380-415 V 3N 50 Hz	220-240 V 3 50 Hz	380-415 V 3 50 Hz	440 V 3 60 Hz	60 Hz	RO Osmosis connection	XP Extra power	PS Drain pump	DDE Detergent dispenser	DB Rinse-aid dispenser
HOOD 130 LUX	●	□	€	€	€	----	€	€	●	●
HOOD 130 LUX DA	●	□	€	€	€	----	€	€	●	●
HOOD 130 LUX H+	●	□	€	€	€	----	€	€	●	●
HOOD 130 LUX DA H+	●	□	€	€	€	----	€	€	●	●
HOOD 130 LUX LIFT	●	□	€	€	€	----	€	€	●	●
HOOD 130 LUX LIFT DA	●	□	€	€	€	----	€	€	●	●
HOOD 130 LUX LIFT H+	●	□	€	€	€	----	€	€	●	●
HOOD 130 LUX LIFT DA H+	●	□	€	€	€	----	€	€	●	●
HOOD 130 LUX PLUS H+	●	□	€	€	€	□	€	€	●	----
HOOD 130 LUX PLUS DA H+	●	□	€	€	€	----	€	€	●	----
HOOD 130 LUX HR PLUS H+	●	□	€	€	€	□	€	€	●	----
HOOD 130 LUX HR PLUS DA H+	●	□	€	€	€	----	€	€	●	----
HOOD 130 LUX PLUS LIFT H+	●	□	€	€	€	□	€	€	●	----
HOOD 130 LUX PLUS LIFT DA H+	●	□	€	€	€	----	€	€	●	----
HOOD 130 LUX HR PLUS LIFT H+	●	□	€	€	€	□	€	€	●	----
HOOD 130 LUX HR PLUS LIFT DA H+	●	□	€	€	€	----	€	€	●	----

● Standard

□ Upon request

---- Not available

DA Built-in water softener with automatic regeneration

HR Available in case of osmotic water supply, if the electrical conductivity is higher than 200 microsiemens

LIFT Automatic hood lift at the end of the cycle

PLUS Rinse with constant temperature and stabilized consumption

H+ 2 cycles of 630 and 180 seconds with high temperatures, reaching up to 70 °C for washing and 90°C for rinsing

PS Not available with 380-415 V 3 50 Hz and 440 V 3 60 Hz (PLUS models)

EAC label upon request

Water supply 55 °C (not on HR version)

Model	DBE	BT	WRAS	DVGW	CONN.	PAP	ID	DF	FLOAT	CONTROL
	Peristaltic rinse-aid disp.	Break tank	WRAS	DVGW	Connectivity (HACCP)	Booster pump	Double skin	Surface filters Kit	Probes lack det. and rinse aid	Substitute remote control panel
HOOD 130 LUX	€	€	€	€	€	€	●	●	€	----
HOOD 130 LUX DA	€	----	€	€	€	€	●	●	€	----
HOOD 130 LUX H+	€	€	€	€	€	€	●	●	€	----
HOOD 130 LUX DA H+	€	----	€	€	€	€	●	●	€	----
HOOD 130 LUX LIFT	€	€	€	€	€	----	●	●	€	----
HOOD 130 LUX LIFT DA	€	----	€	€	€	----	●	●	€	----
HOOD 130 LUX LIFT H+	€	€	€	€	€	----	●	●	€	----
HOOD 130 LUX LIFT DA H+	€	----	€	€	€	----	●	●	€	----
HOOD 130 LUX PLUS H+	●	●	€	€	€	●	●	●	€	€
HOOD 130 LUX PLUS DA H+	●	----	----	----	€	●	●	●	€	€
HOOD 130 LUX HR PLUS H+	●	●	€	€	€	●	●	●	€	€
HOOD 130 LUX HR PLUS DA H+	●	----	----	----	€	●	●	●	€	€
HOOD 130 LUX PLUS LIFT H+	●	●	€	€	€	●	●	●	€	€
HOOD 130 LUX PLUS LIFT DA H+	●	----	----	----	€	●	●	●	€	€
HOOD 130 LUX HR PLUS LIFT H+	●	●	€	€	€	●	●	●	€	€
HOOD 130 LUX HR PLUS LIFT DA H+	●	----	----	----	€	●	●	●	€	€

XP In case of cold water supply for rinse 8 °C 55 °C, and without any heat recovery, the extra power option is mandatory. + 3000 W with standard voltage only, for further voltage information, please contact us. In case of cold water rinse supply (8-15 °C), is recommended heat recovery option (available on the selected models)

BT-WRAS-DVGW Booster pump included

WRAS DBE included









DVGW Components prescribed by DVGW on request (check option compatibility with the manufacturer)

CONNECTIVITY Includes HACCP option. 10 year plan

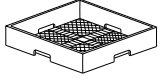
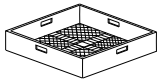
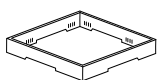
Option compatibility to be confirmed by the manufacturer after verification

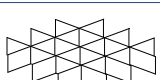
HOOD 130 LUX

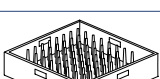
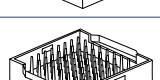
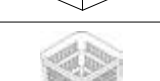
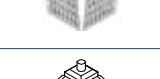
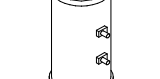
ACCESSORIES

	Description	Capacity	Dimensions	Code
	SLOPED GLASS BASKET	Ø 100 max	500x500x200 H	C 26
	REUSABLE CUP BASKET	5x5 Glass 30 < Ø < 90 mm H max 185 mm	500x500x235 H	C 135 
	NARROW MESH CUTLERY BASKET		500x500x106 H	C 41
	LARGE MESH BASKET	For glasses	500x500x105 H	C 44
	HOLDER FOR GLASS SUPPORT	For glass support (C112-C113-C114)	500x500x50 H	C 111
	GLASS SUPPORT	5x5 Glass Ø 87 mm (C111)	500x500x50 H	C 112
	GLASS SUPPORT	4x4 Glass Ø 110 mm (C111)	500x500x50 H	C 113
	GLASS SUPPORT	6x6 Glass Ø 72 mm (C111)	500x500x50 H	C 114
	PLATE BASKET	18 plates	500x500x105 H	C 40
	GASTRONORM TRAYS BASKET	6 pcs, max. depth 25 mm	500x500x105 H	C 43/B
	CUTLERY BASKET		110x110x120 H	15060
	WATER SOFTENER	12 l	Ø 200x500 H	DEP 12
	AUTOMATIC WATER SOFTENER	12 l (max 800 l)	315x510x685 H	DEP 12-AUT
	OSMOSIS FOR ALL PREMIUM MODELS	230 V 50 Hz - 250 W 5° C - 35° C Flow rate 240 l/h Not suitable for machine with integrated water softener Special basket dotation	226x522x452 H 20 Kg	K OS240 +

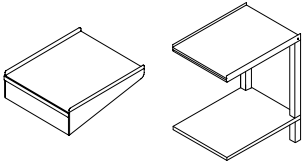
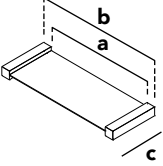
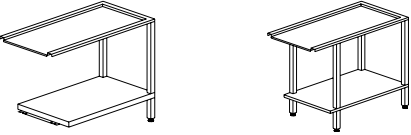
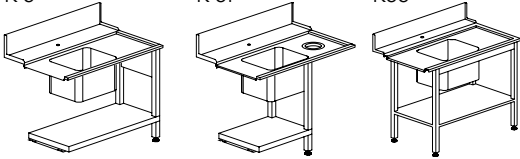
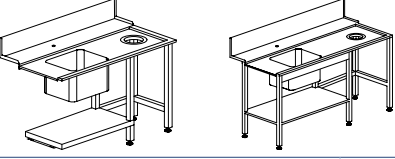
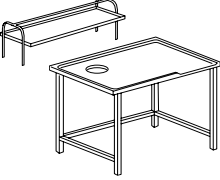
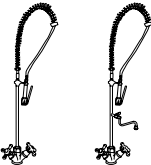
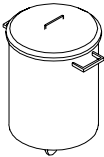
	Description	Capacity	Dimensions	Code
	SHELF TABLE	Only for exit	600x510 650x510x860 H	K 2ME K 4/65
	HOOD CONNECTION SHELF		a: 510 b: 590 c: 239	KIT DUO
K 4/70 B - K 4/120 B K 4B				
	TABLE (line implementation for KP MAXXI PLUS)		700x590x860 H 1200x590x860 H 1200x590x860 H	K 4/70B K 4/120B K 4B
K 5 K 5F K55				
	Sink 500x400x270 H		1200x730x860 H 1200x730x860 H 1200x730x860 H	K 5 K 5F K 55
K 8E K 8 - K 9				
	Sink 500x400x270 H		1500x730x860 H 1500x730x860 H 1800x730x860 H	K 8 K 8E K 9
	SHELF GRADING TABLE WITH RUBBER RING AND HOLE	Special dimensions upon request	1515x620x660 H 2315x620x660 H 1600x1000x850 H 2400x1000x850 H	K 7M16 * K 7M24 * K 7A/1600 * K 7A/2400 *
	FLEXIBLE SHOWER complete with mixing group and lever tap, to be fixed to the wall FLEXIBLE SHOWER complete with mixing group and lever tap, to be fixed to the wall and intermediate tap		1000 H 1000 H	K 1 K 1HR
	STAINLESS STEEL WASTE BIN	Basic model With wheels With wheels and pedal board	Ø 400x570 H Ø 400x570 H Ø 400x570 H	K 7/1 K 7/2 K 7/3

* Wooden cage +2% minimum + €
Special dimensions for tables upon request
Tables shown in right-to-left version

HOOD 130 MAXXI PLUS H+

MULTIPURPOSE
HOOD-TYPE DISHWASHER



We introduce the new versatile hood-type dishwasher, an innovative product designed to simplify the washing of objects of different sizes in an easy-to-use and efficient way. Equipped with a large basket of 600 x 500 mm, these machines can accommodate plates, glasses, pans and other objects of different sizes, ensuring impeccable results. Thanks to customizable washing programs, 2 Hygiene + cycles and an advanced

technology, this model guarantees perfect results in a short time, saving energy and water. A robust and resistant structure allows to last over time and offers high performance even after numerous uses. Whether you need to wash dishes in restaurant, bar or canteen, the pass-through multifunction dishwasher is the ideal choice to ensure a more efficient management of your time.

A₀=30
HYGIENE +

HYGIENE+ SYSTEM

The HYGIENE+ models perform long cycles at high temperatures to fulfill high levels of hygiene, now more essential than ever for our health. These special programs comply with A₀=30 on the scale of thermo-disinfection according to the norm EN ISO 15883-1.

The HYGIENE+ models include 2 special cycles, a short one of 180 seconds and a longer one of 630 seconds, ensuring compliance with high levels of hygiene thanks to high temperatures and long cycles.

FEATURES

STANDARD

- Basket 600 x 500 mm
- Useful height 450 mm
- 6 wash cycles: 4 customizable cycles
- Easy and intuitive electronic control panel
- Double skin insulated hood
- Deep tank
- Double tank filters, with dirt collection system and pump filter (improved system for a better filtration of the wash water)
- Self-cleaning vertical pump
- Water consumption and working time control system
- Easy to access for maintenance
- Anti-drop roof panel
- Easily removable basket support
- Linear or corner layouts
- Self-cleaning cycle
- Peristaltic detergent and rinse aid dispensers included with dosage adjustable from the control panel
- The PLUS system grants a constant rinse temperature and pressure

OPTIONS

- ENERGY SAVING HR system: heat recovery and steam condenser
- D: Built-in water softener recommended for water > 8°f; max 35°f
- CONNECTIVITY remote control compliant with the HACCP norms
- Remote control panel available on request instead of the standard control panel
- Predisposition for connection to an external device of reverse osmosis



HOOD 130 MAXXI PLUS H+

MULTIPURPOSE
HOOD-TYPE DISHWASHER

CONNECTIVITY 4.0 & APP

WHEREVER YOU ARE...

YOUR DISHWASHER, JUST A CLICK AWAY

You will be constantly connected to the machine to monitor the work phases, review any eventual alarm and configure remotely the operating parameters according to your needs. Compliant with HACCP norms. Thanks to our brand new App, you will have access to connected machines and all commercial and technical documentation.

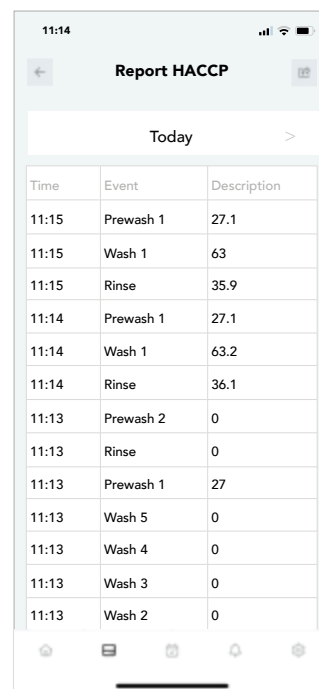
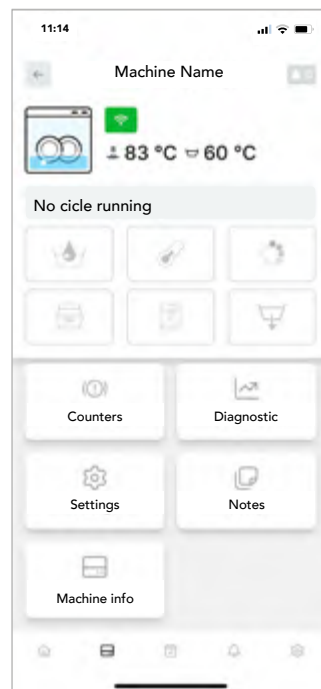

View all the working parameters and event records, working hours and any problem at any time.



In case of problem, the machine promptly alerts you. The technician can intervene remotely to solve the problem or anticipate the needed parts for an on-site intervention.



A daily activity report is available with all the events related to the dishwasher in a detailed spreadsheet with HACCP data.



Our Connectivity system is a revolutionary device limiting and facilitating the eventual intervention of a technician who can anticipate the necessary parts to be replaced, saving time and money.

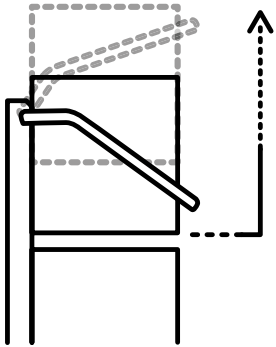

IMPROVED LIFT SYSTEM:

AUTOMATIC TWO-STEP HOOD LIFT AT THE END OF THE CYCLE

The hydraulic system has been replaced by an electric motor. Its simplicity limits maintenance and the formation of limescale. The latter, freeing up space, allows to add more options to the LIFT models such as the integrated automatic softener.

PLUS SYSTEM

GUARANTEED RINSE EVEN WITH LOW PRESSURE OF THE WATER INLET

We have developed an innovative rinsing system at constant temperature, consumption and water pressure, regardless of external conditions. The PLUS System ensures optimal and constant rinsing performance thanks to the combination of Break Tank, atmospheric boiler and rinse pump.

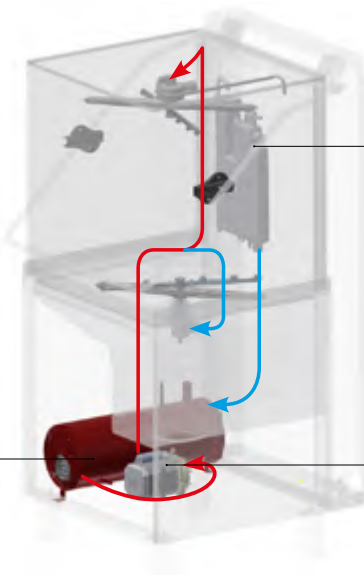

BREAK TANK

The Break Tank system prevents the heated water of the boiler to go back and mix with the fresh water supply.

ATMOSPHERIC BOILER

The water temperature in the boiler remains constant at 85°C throughout the rinse, as the boiler refill only occurs once the rinse cycle is done.

RINSE PUMP

The water is sucked from the boiler through a rinse pump and is sent to the rinse nozzles. The correct pressure is ensured regardless of the water inlet pressure and temperature.





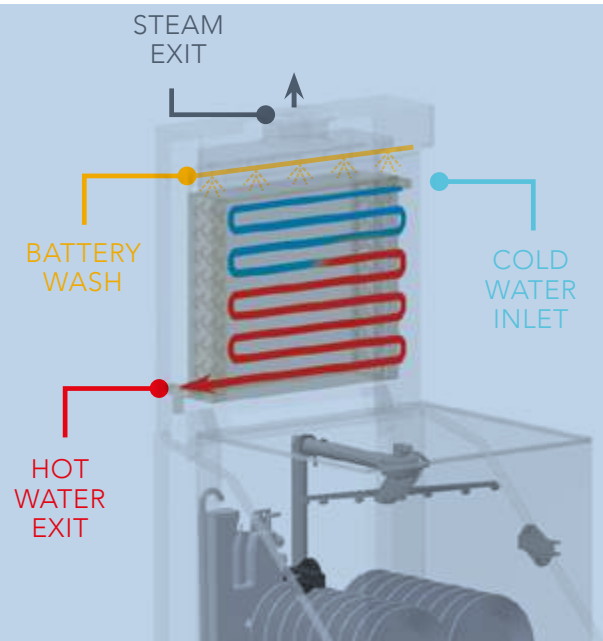





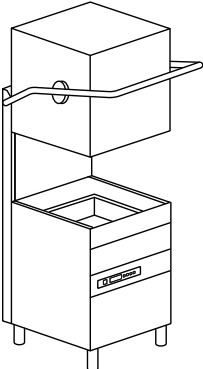

HR - ENERGY RECOVERY

The ENERGY RECOVERY system uses the heat produced by the machine to preheat the inlet cold water (8-15 °C). This is an immediate saving on energy costs. Additionally, an optimal temperature in the dishwashing area is achieved as the air is no more affected by steam and humidity.

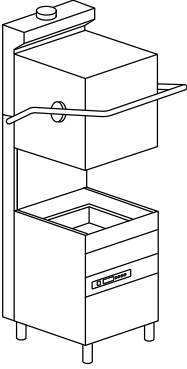











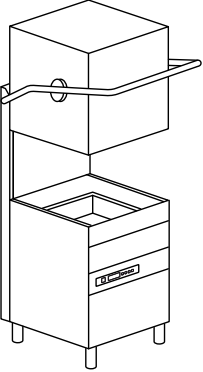

HOOD 130 MAXXI PLUS H+

MULTIPURPOSE
HOOD-TYPE DISHWASHER

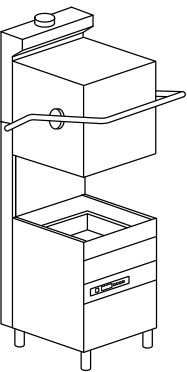
Model	Voltage	Capacity	Dimensions	Code
HOOD 130 MAXXI PLUS H+ ELECTRONIC 6 PROGRAMS				
 <p>RACK EQUIPMENT 1 X C136 1 X C137 1 X C138 2 X 15060</p> <p>A₀=30 HYGIENE +</p>	400 V 3N ~ 50 Hz 10,5 kW	 <p>Ø 310</p>  <p>310 < Ø < 410 *</p>  <p>600x500</p>	<p>800x735x 1490/1961 H 120 kg</p>  <p>530x325x25 H</p>  <p>600x400x25 H</p>	<p>HOOD 130 MAXXI PLUS H+</p> <p>HOOD 130 MAXXI PLUS DA H+</p>
HOOD 130 MAXXI HR PLUS H+ ELECTRONIC 6 PROGRAMS				
 <p>RACK EQUIPMENT 1 X C136 1 X C137 1 X C138 2 X 15060</p> <p>A₀=30 HYGIENE +</p>	400 V 3N ~ 50 Hz 10,5 kW	 <p>Ø 310</p>  <p>310 < Ø < 410 *</p>  <p>600x500</p>	<p>800x735x2162 H 150 kg</p>  <p>530x325x25 H</p>  <p>600x400x25 H</p>	<p>HOOD 130 MAXXI HR PLUS H+</p> <p>HOOD 130 MAXXI HR PLUS DA H+</p>

* Usable plate diameter: from 310 mm to 410 mm

X Con cesto speciale da ordinare

Model	Voltage	Capacity	Dimensions	Code
HOOD 130 MAXXI PLUS LIFT H+ 	ELECTRONIC 6 PROGRAMS RACK EQUIPMENT 1 X C136 1 X C137 1 X C138 2 X 15060 A₀=30 HYGIENE +	400 V 3N ~ 50 Hz 10,5 kW	 Ø 310  310 < Ø < 410 *  600x500	800x735x 1490/1961 H 120 kg  530x325x25 H  600x400x25 H HOOD 130 MAXXI PLUS LIFT H+ HOOD 130 MAXXI PLUS LIFT DA H+
HOOD 130 MAXXI HR PLUS LIFT H+ 	ELECTRONIC 6 PROGRAMS RACK EQUIPMENT 1 X C136 1 X C137 1 X C138 2 X 15060 A₀=30 HYGIENE +	400 V 3N ~ 50 Hz 10,5 kW	 Ø 310  310 < Ø < 410 *  600x500	800x735x2162 H 150 kg  530x325x25 H  600x400x25 H HOOD 130 MAXXI HR PLUS LIFT H+ HOOD 130 MAXXI HR PLUS LIFT DA H+

OPTIONS

	RO	XP	PS	DDE					
Model	380-415 V 3N 50 Hz	220-240V 3 50 Hz	380-415 V 3 50 Hz	440 V 3 60 Hz	60 Hz	Osmosis connection	Extra power	Drain pump	Detergent dispenser
HOOD 130 MAXXI PLUS H+	●	□	€	€	€	□	€	€	●
HOOD 130 MAXXI PLUS DA H+	●	□	€	€	€	----	€	€	●
HOOD 130 MAXXI HR PLUS H+	●	□	€	€	€	□	€	€	●
HOOD 130 MAXXI HR PLUS DA H+	●	□	€	€	€	----	€	€	●
HOOD 130 MAXXI PLUS LIFT H+	●	□	€	€	€	□	€	€	●
HOOD 130 MAXXI PLUS LIFT DA H+	●	□	€	€	€	----	€	€	●
HOOD 130 MAXXI HR PLUS LIFT H+	●	□	€	€	€	□	€	€	●
HOOD 130 MAXXI HR PLUS LIFT DA H+	●	□	€	€	€	----	€	€	●

- Standard
- Upon request
- Not available
- DA** Built-in water softener with automatic regeneration
- HR** Available with osmotic water supply only if the electrical conductivity is higher than 200 microsiemens
- PLUS** Rinse with constant temperature and stabilized consumption
- H+** 2 cycles of 630 and 180 seconds with high temperatures, reaching up to 70 °C for washing and 90°C for rinsing

Water supply 55 °C (not on HR version)

EAC label upon request

Model	DBE	BT	WRAS	DVGW	CONN.	PAP	ID	DF	FLOAT	CONTROL
	Peristaltic rinse-aid disp.	Break tank	WRAS	DVGW	Connectivity (HACCP)	Booster pump	Double skin	Surface filters kit	Probes lack det. and rinse aid	Substitute remote control panel
HOOD 130 MAXXI PLUS H+	●	●	€	€	€	●	●	●	€	€
HOOD 130 MAXXI PLUS DA H+	●	----	€	€	€	●	●	●	€	€
HOOD 130 MAXXI HR PLUS H+	●	●	----	----	€	●	●	●	€	€
HOOD 130 MAXXI HR PLUS DA H+	●	----	----	----	€	●	●	●	€	€
HOOD 130 MAXXI PLUS LIFT H+	●	●	€	€	€	●	●	●	€	€
HOOD 130 MAXXI PLUS LIFT DA H+	●	----	€	€	€	●	●	●	€	€
HOOD 130 MAXXI HR PLUS LIFT H+	●	●	----	----	€	●	●	●	€	€
HOOD 130 MAXXI HR PLUS LIFT DA H+	●	----	----	----	€	●	●	●	€	€

PS Not available with 380-415 V 3 50 Hz and 440 V 3 60 Hz

XP In case of cold water supply for rinse 8 °C 55 °C, and without any heat recovery, the extra power option is mandatory. + 3000 W with standard voltage only, for other voltages please contact us. In case of cold water supply for rinse 8-15 °C, We recommend the heat recovery option.

BT - WRAS - DVGW Booster pump included



DVGW Components prescribed by DVGW on request (check option compatibility with the manufacturer)

CONNECTIVITY Includes HACCP option. 10 year plan

HR Heat recovery (in case of cold water supply 8-15 °C)
The ENERGY RECOVERY system uses the heat produced by the machine to preheat the infeed of cold rinse water supply (8-15 °C)
Optimal air temperature in the dishwashing area thanks to the reduction of the steam and the humidity produced by the machine
HR available with osmotic water supply, only if the electrical conductivity is higher than 200 microsiemens

Option compatibility to be confirmed by the manufacturer after verification

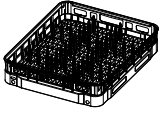
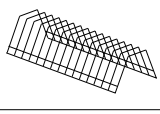
HOOD 130 MAXXI PLUS H+ ACCESSORIES

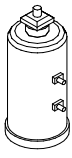
	Description	Capacity	Dimensions	Code	
	PLATE BASKET	Standard 22 plates Ø < 310 mm	600x500x115 H	C 136	
	LARGE MESH BASKET	Standard	600x500x115 H	C 137	
	TRAYS OR PLATES BASKET	Standard 12 trays up to 47 cm wide or for 10 GN1/1 (max depth 2,5 cm) or 11 plates 310 < Ø < 410 mm (max depth 2,5 cm)	600x500x115 H	C 138	
	TRAYS BASKET	6 pcs max depth 2,5 cm	620x500x160 H	C 139	
	SAUCER HOLDER	12 saucers	300x100x90 H	10728	
	CUTLERY BASKET	Standard (2 pcs)	110x110x120 H	15060	
	WATER SOFTENER	12 l	Ø 200x500 H	DEP 12	
	AUTOMATIC WATER SOFTENER	12 l (max 800 l)	315x510x685 H	DEP 12-AUT	
	OSMOSIS FOR ALL PREMIUM MODELS	230 V 50 Hz - 250 W 5° C - 35° C Flow rate 240 l/h Not suitable for machine with integrated water softener Special basket dotation	226x522x452 H 20 Kg	K OS240 +	
	SHELF	Only for exit	600x510	K 2ME *	
	TABLE		650x510x860 H	K 4/65 *	

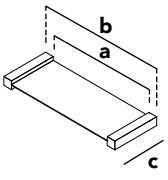
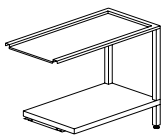
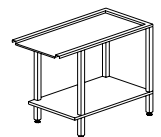
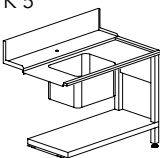
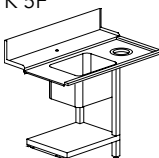
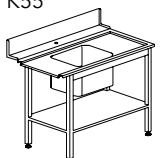
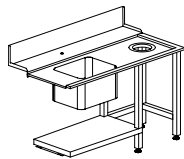
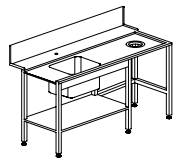
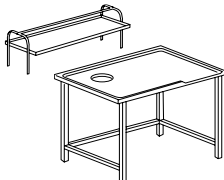
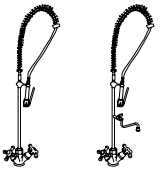
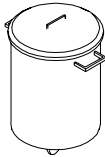
	Description	Capacity	Dimensions	Code	
	HOOD CONNECTION SHELF		a: 510 b: 590 c: 239	KIT DUO	
K 4/70 B - K 4/120 B 	K 4B 	TABLE (line implementation for KP MAXXI PLUS)*	700x590x860 H 1200x590x860 H 1200x590x860 H	K 4/70B * K 4/120B * K 4B *	
K 5 	K 5F 	K55 	Sink 500x400x270 H (line implementation for KP MAXXI PLUS)*	1200x730x860 H 1200x730x860 H 1200x730x860 H	K 5 * K 5F * K 55 *
K 8 	K 8 E - K 9 	Sink 500x400x270 H (line implementation for KP MAXXI PLUS)*	1500x730x860 H 1500x730x860 H 1800x730x860 H	K 8 * K 8E * K 9 *	
	SHELF		1515x620x660 H 2315x620x660 H	K 7M16 ** K 7M24 **	
	GRADING TABLE WITH RUBBER RING	Waste hole and special dimensions upon request	1600x1000x850 H 2400x1000x850 H	K 7A/1600 ** K 7A/2400 **	
	FLEXIBLE SHOWER complete with mixing group and lever tap, to be fixed to the wall		1000 H	K 1	
	FLEXIBLE SHOWER complete with mixing group and lever tap, to be fixed to the wall and intermediate tap		1000 H	K 1HR	
	STAINLESS STEEL WASTE BIN	Basic model	Ø 400x570 H	K 7/1	
		With wheels	Ø 400x570 H	K 7/2	
		With wheels and pedal board	Ø 400x570 H	K 7/3	

** Wooden cage +2% minimum + €
Special dimensions for tables upon request
Tables shown in right-to-left version

* Standard tables for linear installations. For tables positioned in front of the machine, a special table must be designed.
Do not hesitate to contact us for more information.

HOOD 140 PREMIUM

CONNECTED HOOD-TYPE DISHWASHERS
WITH CLEAN WATER TECHNOLOGY



We simply combined the highest specs and ultimate new technology to the time-tested name and features. HOOD 140 PREMIUM is our answer to the new high standards of hygiene and cleanliness of the worldwide market, keeping our renowned low operating costs thanks to the OPTIMAL RINSE system. Our HYGIENE+ cycles ($A_0=60$) will guarantee to work safely by keeping top sanitation levels. The settable additional cycle and the available self-monitoring technology and CONNECTIVITY makes the HOOD

140 PREMIUM the range you have been expecting. An intuitive and interactive electronic panel will lead you through the new functions of your dishwasher. Its self-diagnosis system notifies any anomaly and clearly shows the different steps of the cycle and status of your dishwasher. 6 wash cycles (8 for the HYGIENE+ version) and the easy change of voltage make these machines incredibly versatile and easy to install.

A₀=60
HYGIENE +

HYGIENE+ SYSTEM

Our HYGIENE + models, with high temperatures and long cycles, ensure compliance with high levels of hygiene, nowadays more essential than ever for our personal health. We designed this range according to strict standards and parameters of thermal disinfection. All our HYGIENE + models obtain the A₀ 60 level, reducing pathogenic microorganisms and bacterial load according to the norm EN ISO 15883-1. Two cycles with high temperatures (180 and 630 seconds), reaching up to 75°C for washing and 90°C for rinsing, guarantee a full compliance with the disinfection principles.



FEATURES

- Partial anticipated drain of waste water thanks to the standard drain-pump, waste wash water is partially drained before rinsing. At each cycle, wash water is cleaner, already warm and added with detergent and rinse-aid
- The innovative deep-formed tank with reduced volume allows significant savings on water, energy and chemicals also avoiding water stagnation
- Standard version: six wash cycles with partial drain of the wash water before rinsing
- Hygiene+ version: eight wash cycles, six with partial drain of the wash water before rinsing and two Hygiene+ programs
- Combined stainless steel wash and rinse arms system with non-clogging nozzles
- Detergent and rinse-aid dosage setting, directly from the control panel
- Self-cleaning vertical washing pump for greater operating hygiene
- Built-in peristaltic detergent and rinse-aid dispensers
- Double skin insulated hood
- PLUS system to grant a constant rinse temperature and pressure
- Water consumption and working time control system (PLUS versions)
- Break Tank system to prevent backflow contaminations in the piping network
- User-friendly multichrome START key
- Electronic control panel with TFT screen
- Language selection and menu personalization
- Self-diagnostic system, for users and service staff
- Self-cleaning cycle
- Soft Start wash pump that offers additional protection for the most delicate objects
- D: built-in water softener recommended for water > 8°f; max 35°f
- Optional replacement remote control panel available
- CONNECTIVITY remote control compliant with the HACCP norms (on request)

HOOD 140 PREMIUM

CONNECTED HOOD-TYPE DISHWASHERS
WITH CLEAN WATER TECHNOLOGY

CONNECTIVITY 4.0 & APP

WHEREVER YOU ARE...

YOUR DISHWASHER, JUST A CLICK AWAY

You will be constantly connected to the machine to monitor the work phases, review any eventual alarm and configure remotely the operating parameters according to your needs. Compliant with HACCP norms. Thanks to our brand new App, you will have access to connected machines and all commercial and technical documentation.

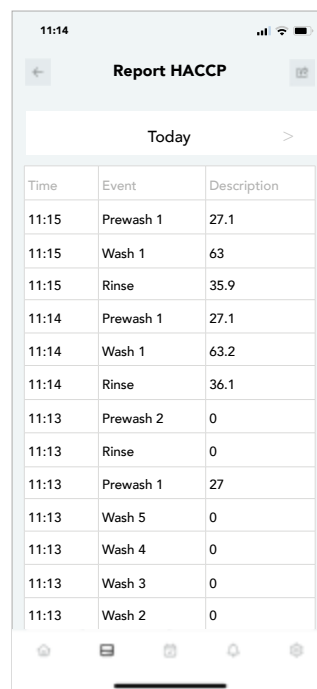
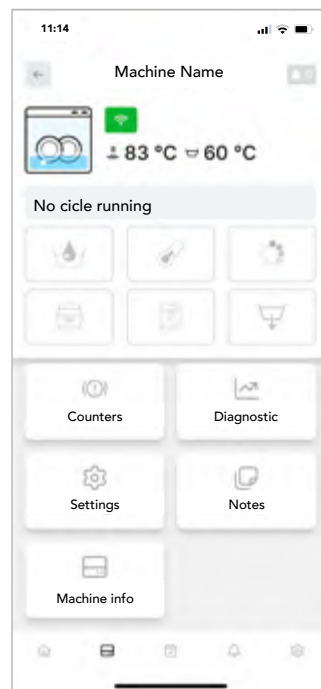

View all the working parameters and event records, working hours and any problem at any time.



In case of problem, the machine promptly alerts you. The technician can intervene remotely to solve the problem or anticipate the needed parts for an on-site intervention.



A daily activity report is available with all the events related to the dishwasher in a detailed spreadsheet with HACCP data.



Our Connectivity system is a revolutionary device limiting and facilitating the eventual intervention of a technician who can anticipate the necessary parts to be replaced, saving time and money.

NEW HIGH-TECH BACKLIT DISPLAY

This new intuitive technology with colored icons, combined with a handy multi-color START, make the machine simple and efficient to use. In addition, the introduction of the new 'customizable cycles' function allows the installer to easily change all parameters related to the wash phase, pause and rinse length and temperatures according to the user's needs. The LED display provides information on the current status of the machine and on ongoing events such as errors, anomalies, temperatures, cycle selection, cycle progression, lack of salt if water softener included and many other indicators depending on the options selected during the configuration phase.

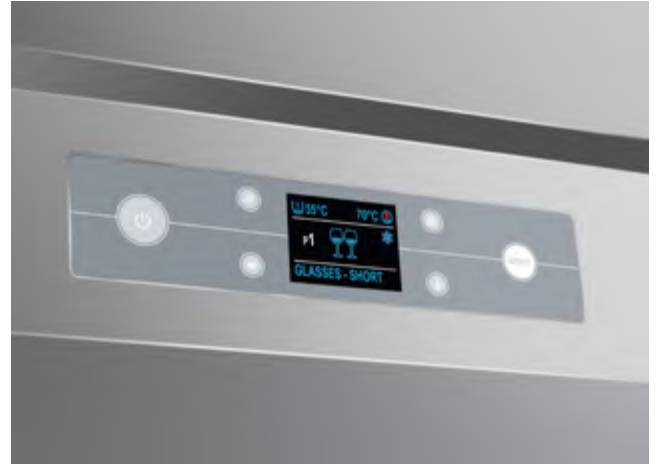

IMPROVED LIFT SYSTEM:

AUTOMATIC TWO-STEP HOOD LIFT AT THE END OF THE CYCLE

The hydraulic system has been replaced by an electric motor. Its simplicity limits maintenance and the formation of limescale. The latter, freeing up space, allows to add more options to the LIFT models such as the integrated automatic softener.

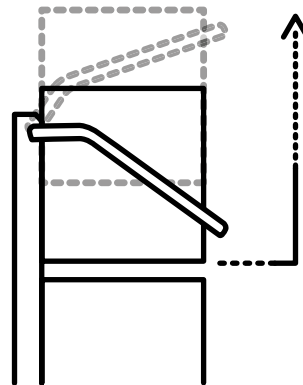





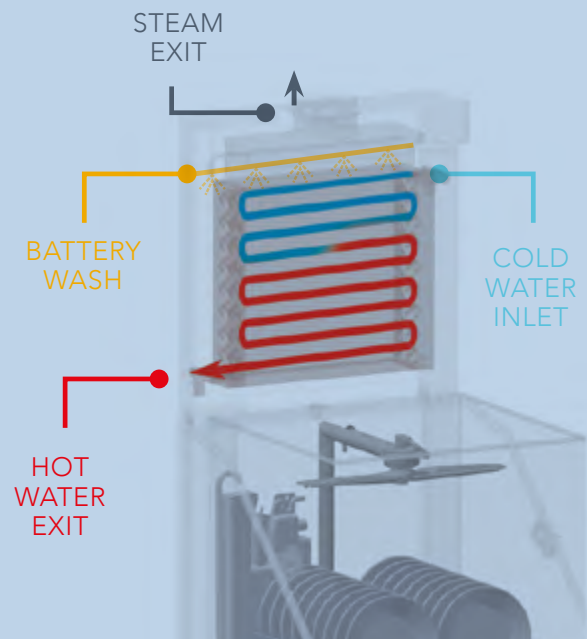





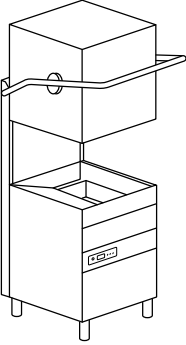



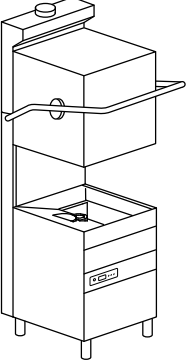

HR - ENERGY RECOVERY

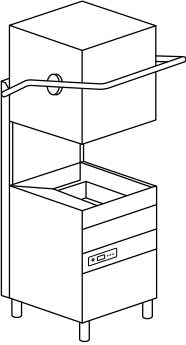
The ENERGY RECOVERY system uses the heat produced by the machine to preheat the inlet cold water (8-15 °C). This is an immediate saving on energy costs. Additionally, an optimal temperature in the dishwashing area is achieved as the air is no more affected by steam and humidity.

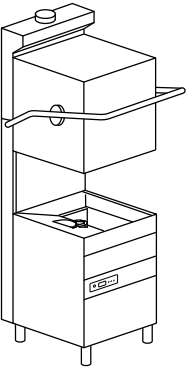

HOOD 140 PREMIUM

CONNECTED HOOD-TYPE DISHWASHERS
WITH CLEAN WATER TECHNOLOGY

Model	Voltage	Capacity	Dimensions	Code
HOOD 140 PREMIUM ELECTRONIC 6 PROGRAMS				
	<p>RACK EQUIPMENT</p> <ul style="list-style-type: none"> 2 X C40 1 X C44 2 X 15060 	Multivoltage	 	<p>720x735x 1445/1880 H 125 kg</p> <p> 530x325x25 H</p>
		<p>standard 400 V 3N 50 Hz (9,9 kW)</p> <p>--</p> <p>230 V 3 50 Hz (9,9 kW)</p> <p>--</p> <p>230 V 50 Hz (9,9 kW)</p>		
HOOD 140 PREMIUM HR ELECTRONIC 6 PROGRAMS - HR: HEAT RECOVERY				
	<p>RACK EQUIPMENT</p> <ul style="list-style-type: none"> 2 X C40 1 X C44 2 X 15060 	Multivoltage	 	<p>720x735x 2095 H 145 kg</p> <p> 530x325x25 H</p>
		<p>standard 400 V 3N 50 Hz (9,9 kW)</p> <p>--</p> <p>230 V 3 50 Hz (9,9 kW)</p> <p>--</p> <p>230 V 50 Hz (9,9 kW)</p> <p>HR: Cold water supply</p>		
HOOD 140 PREMIUM LIFT ELECTRONIC 6 PROGRAMS				
	<p>RACK EQUIPMENT</p> <ul style="list-style-type: none"> 2 X C40 1 X C44 2 X 15060 	Multivoltage	 	<p>720x735x 1445/1880 H 125 kg</p> <p> 530x325x25 H</p>
		<p>standard 400 V 3N 50 Hz (9,9 kW)</p> <p>--</p> <p>230 V 3 50 Hz (9,9 kW)</p> <p>--</p> <p>230 V 50 Hz (9,9 kW)</p>		
HOOD 140 PREMIUM HR LIFT ELECTRONIC 6 PROGRAMS - HR: HEAT RECOVERY				
	<p>RACK EQUIPMENT</p> <ul style="list-style-type: none"> 2 X C40 1 X C44 2 X 15060 	Multivoltage	 	<p>720x735x 2095 H 145 kg</p> <p> 530x325x25 H</p>
		<p>standard 400 V 3N 50 Hz (9,9 kW)</p> <p>--</p> <p>230 V 3 50 Hz (9,9 kW)</p> <p>--</p> <p>230 V 50 Hz (9,9 kW)</p> <p>HR: Cold water supply</p>		

X With special basket to be ordered

Model	Voltage	Capacity	Dimensions	Code
HOOD 140 PREMIUM H+ ELECTRONIC 8 PROGRAMS				
	Multivoltage			
	standard 400 V 3N 50 Hz (9,9 kW)		720x735x 1445/1880 H 125 kg	HOOD 140 PREMIUM H+
	-- 230 V 3 50 Hz (9,9 kW)			HOOD 140 PREMIUM DA H+
	-- 230 V 50 Hz (9,9 kW)			
<p>RACK EQUIPMENT 2 X C40 1 X C44 2 X 15060</p> <p>A₀=60 HYGIENE +</p>				
HOOD 140 PREMIUM HR H+ ELECTRONIC 8 PROGRAMS - HR: HEAT RECOVERY				
	Multivoltage			
	standard 400 V 3N 50 Hz (9,9 kW)		720x735x 2095 H 145 kg	HOOD 140 PREMIUM HR H+
	-- 230 V 3 50 Hz (9,9 kW)			HOOD 140 PREMIUM HR DA H+
	-- 230 V 50 Hz (9,9 kW)			
<p>RACK EQUIPMENT 2 X C40 1 X C44 2 X 15060</p> <p>A₀=60 HYGIENE +</p>	HR: Cold water supply			
HOOD 140 PREMIUM LIFT H+ ELECTRONIC 8 PROGRAMS				
	Multivoltage			
	standard 400 V 3N 50 Hz (9,9 kW)		720x735x 1445/1880 H 125 kg	HOOD 140 PREMIUM LIFT H+
	-- 230 V 3 50 Hz (9,9 kW)			HOOD 140 PREMIUM LIFT DA H+
	-- 230 V 50 Hz (9,9 kW)			
<p>RACK EQUIPMENT 2 X C40 1 X C44 2 X 15060</p> <p>A₀=60 HYGIENE +</p>				
HOOD 140 PREMIUM HR LIFT H+ ELECTRONIC 8 PROGRAMS - HR: HEAT RECOVERY				
	Multivoltage			
	standard 400 V 3N 50 Hz (9,9 kW)		720x735x 2095 H 145 kg	HOOD 140 PREMIUM HR LIFT H+
	-- 230 V 3 50 Hz (9,9 kW)			HOOD 140 PREMIUM HR LIFT DA H+
	-- 230 V 50 Hz (9,9 kW)			
<p>RACK EQUIPMENT 2 X C40 1 X C44 2 X 15060</p> <p>A₀=60 HYGIENE +</p>	HR: Cold water supply			

A₀=60 Special programs complying with A₀=60 on the scale of thermo-disinfection according to the norm EN ISO 15883-1. All our Hygiene+ models reach the A₀ 60 level defining the minimum reduction level of pathogenic microorganisms and bacterial load. In addition, our Plus Rinsing System guarantees a perfect rinse with steady temperature and water pressure for optimal hygienic results

HOOD 140 PREMIUM

CONNECTED HOOD-TYPE DISHWASHERS
WITH CLEAN WATER TECHNOLOGY

OPTIONS

Model	* 220-240 V 50 Hz	380-415 V 3N 50 Hz	220-240 V 3 50 Hz	60 Hz	CONTROL Replacement remote control panel	RO Osmosis connection	XP Extra power	PS Drain pump	DDE Deter- gent dispens- er	DBE Peristaltic rinse-aid disp.
HOOD 140 PREMIUM	M	●	M	€	€	□	€	●	●	●
HOOD 140 PREMIUM DA	M	●	M	€	€	----	€	●	●	●
HOOD 140 PREMIUM HR	M	●	M	€	€	□	----	●	●	●
HOOD 140 PREMIUM HR DA	M	●	M	€	€	----	----	●	●	●
HOOD 140 PREMIUM H+	M	●	M	€	€	□	€	●	●	●
HOOD 140 PREMIUM DA H+	M	●	M	€	€	----	€	●	●	●
HOOD 140 PREMIUM HR H+	M	●	M	€	€	□	----	●	●	●
HOOD 140 PREMIUM HR DA H+	M	●	M	€	€	----	----	●	●	●
HOOD 140 PREMIUM LIFT	M	●	M	€	€	□	€	●	●	●
HOOD 140 PREMIUM LIFT DA	M	●	M	€	€	----	€	●	●	●
HOOD 140 PREMIUM HR LIFT	M	●	M	€	€	□	----	●	●	●
HOOD 140 PREMIUM HR LIFT DA	M	●	M	€	€	----	----	●	●	●
HOOD 140 PREMIUM LIFT H+	M	●	M	€	€	□	€	●	●	●
HOOD 140 PREMIUM LIFT DA H+	M	●	M	€	€	----	€	●	●	●
HOOD 140 PREMIUM HR LIFT H+	M	●	M	€	€	□	----	●	●	●
HOOD 140 PREMIUM HR LIFT DA H+	M	●	M	€	€	----	----	●	●	●

● Standard

□ Upon request

---- Not available

M Multivoltage

DA Built-in water softener with automatic regeneration

HR Available in case of osmotic water supply, if the electrical conductivity is higher than 200 microsiemens

H+ (HYGIENE+) 2 cycles of 630 and 180 seconds with high temperatures, reaching up to 75 °C for washing and 90°C for rinsing

* XP (extra power) not available for this voltage

EAC label upon request

Water supply 55 °C (not on HR version)

Model	TS	ST	BT	WRAS	DVGW	CONN.	PAP	ID	DF	FLOAT
	Thermostop system	Soft start	Break tank	WRAS	DVGW	Connectivity (HACCP)	Rinse pump	Double skin	Surface filters kit	Probes lack det. and rinse aid
HOOD 140 PREMIUM	●	●	●	€	€	€	●	●	●	€
HOOD 140 PREMIUM DA	●	●	----	----	----	€	●	●	●	€
HOOD 140 PREMIUM HR	●	●	●	----	----	€	●	●	●	€
HOOD 140 PREMIUM HR DA	●	●	----	----	----	€	●	●	●	€
HOOD 140 PREMIUM H+	●	●	●	€	€	€	●	●	●	€
HOOD 140 PREMIUM DA H+	●	●	----	----	----	€	●	●	●	€
HOOD 140 PREMIUM HR H+	●	●	●	----	----	€	●	●	●	€
HOOD 140 PREMIUM HR DA H+	●	●	----	----	----	€	●	●	●	€
HOOD 140 PREMIUM LIFT	●	●	●	€	€	€	●	●	●	€
HOOD 140 PREMIUM LIFT DA	●	●	----	----	----	€	●	●	●	€
HOOD 140 PREMIUM HR LIFT	●	●	●	----	----	€	●	●	●	€
HOOD 140 PREMIUM HR LIFT DA	●	●	----	----	----	€	●	●	●	€
HOOD 140 PREMIUM LIFT H+	●	●	●	€	€	€	●	●	●	€
HOOD 140 PREMIUM LIFT DA H+	●	●	----	----	----	€	●	●	●	€
HOOD 140 PREMIUM HR LIFT H+	●	●	●	----	----	€	●	●	●	€
HOOD 140 PREMIUM HR LIFT DA H+	●	●	----	----	----	€	●	●	●	€

SOFT START Progressive start of the wash pump

XP In case of cold water supply for rinse 8 °C 55 °C, and without any heat recovery, the extra power option is mandatory. + 3000 W with standard voltage only, for other voltages please contact us. In case of cold water supply for rinse 8-15 °C, we recommend the heat recovery option, if available on the selected model

BT - WRAS - DVGW Booster pump included

DVGW Components prescribed by DVGW on request (check option compatibility with the manufacturer)





CONNECTIVITY Includes HACCP option. 10 year plan

LIFT Automatic two-step hood lift at the end of the cycle

Option compatibility to be confirmed by the manufacturer after verification

HOOD 140 PREMIUM

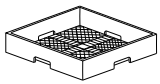
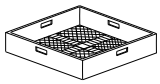
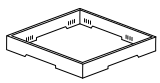
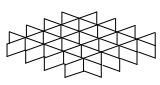
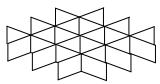
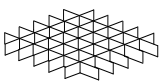
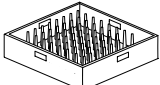
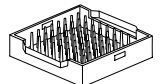
ACCESSORIES

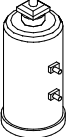
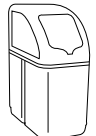
	Description	Capacity	Dimensions	Code
	SLOPED GLASS BASKET	Ø 100 max	500x500x200 H	C 26
	REUSABLE CUP BASKET	5x5 Glass 30 < Ø < 90 mm H max 185 mm	500x500x235 H	C 135 
	NARROW MESH CUTLERY BASKET		500x500x106 H	C 41
	LARGE MESH BASKET	For glasses	500x500x105 H	C 44
	HOLDER FOR GLASS SUPPORT	For glass support (C112-C113-C114)	500x500x50 H	C 111
	GLASS SUPPORT	5x5 Glass Ø 87 mm (C111)	500x500x50 H	C 112
	GLASS SUPPORT	4x4 Glass Ø 110 mm (C111)	500x500x50 H	C 113
	GLASS SUPPORT	6x6 Glass Ø 72 mm (C111)	500x500x50 H	C 114
	PLATE BASKET	18 plates	500x500x105 H	C 40
	GASTRONORM TRAYS BASKET	6 pcs, max. depth 25 mm	500x500x105 H	C 43/B
	CUTLERY BASKET		110x110x120 H	15060
	WATER SOFTENER	12 l	Ø 200x500 H	DEP 12
	AUTOMATIC WATER SOFTENER	12 l (max 800 l)	315x510x685 H	DEP 12-AUT

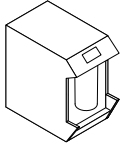
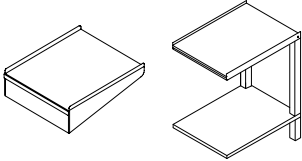
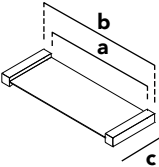
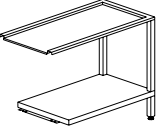
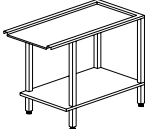
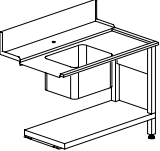
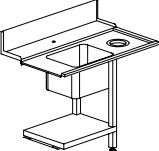
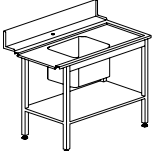
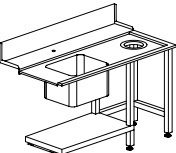
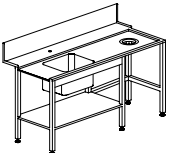
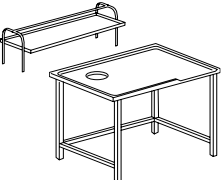
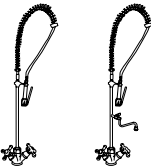
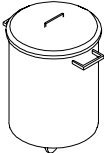
	Description	Capacity	Dimensions	Code
	OSMOSIS FOR ALL PREMIUM MODELS	230 V 50 Hz - 250 W 5° C - 35° C Flow rate 240 l/h Not suitable for machine with integrated water softener Special basket dotation	226x522x452 H 20 Kg	K OS240 +
	SHELF TABLE	Only for exit	600x510 650x510x860 H	K 2ME K 4/65
	HOOD CONNECTION SHELF		a: 510 b: 590 c: 239	KIT DUO
K 4/70 B - K 4/120 B  K 4B 	TABLE		700x590x860 H 1200x590x860 H 1200x590x860 H	K 4/70B K 4/120B K 4B
K 5  K 5F  K55 	Sink 500x400x270 H		1200x730x860 H 1200x730x860 H 1200x730x860 H	K 5 K 5F K 55
K 8E  K 8 - K 9 	Sink 500x400x270 H		1500x730x860 H 1500x730x860 H 1800x730x860 H	K 8 K 8E K 9
	SHELF GRADING TABLE WITH RUBBER RING AND HOLE	Special dimensions upon request	1515x620x660 H 2315x620x660 H 1600x1000x850 H 2400x1000x850 H	K 7M16 * K 7M24 * K 7A/1600 * K 7A/2400 *
	FLEXIBLE SHOWER complete with mixing group and lever tap, to be fixed to the wall FLEXIBLE SHOWER complete with mixing group and lever tap, to be fixed to the wall and intermediate tap		1000 H 1000 H	K 1 K 1HR
	STAINLESS STEEL WASTE BIN	Basic model With wheels With wheels and pedal board	Ø 400x570 H Ø 400x570 H Ø 400x570 H	K 7/1 K 7/2 K 7/3

* Wooden cage +2% minimum + €
Special dimensions for tables upon request. Tables shown in right-to-left version

WASH & STORE

STOCK & WASH
DISHWASHERS



WASH & STORE does the job for you in full comfort, thanks to its ultra-low-sound level and minimal heat loss in the room. Less handling, less breakages, less repeated job, easy load/unload in full ergonomics. WASH & STORE takes care of it all. Dishes can be used immediately, after the cycles end, or can be left stocked in the machine, as in a shelf. WASH & STORE can be installed in whatever room, as nee-

ding one third of space only, when compared to a traditional dishwashing system. WASH & STORE consumes much less water i.e. much less chemicals. The electrical consumption is minimal and, thanks to the delayed Start, you can run it far from electrical peak times. This allows the reduction of power supply and, mainly, reduces the electricity bill.



DOUBLE FACE VERSION

SAVES 65% ON OVERALL SPACE

WASH & STORE is available in two versions: a front-load one and a pass-through one -embedded in a wall- the second allowing a connection between two rooms, providing a net separation between loading area and clean area (kitchen) reducing even more the needed space.



FEATURES

- Thermo-resistant independent glass doors
- Double-wall construction with thermo-acoustic insulation
- Chemicals dosing and monitoring station
- Cold-fog drying system
- Standard steam condenser
- Automatic, built-in water softener (not for HI TEMP version)
- Wheels available for installation
- AISI 316 wash-tank, insulated, with four independent self-cleaning pumps
- Remote control available
- Low-sound level
- Can be installed in whatever room
- Consumes remarkably much less water i.e. much less chemicals
- Minimal electrical consumption and possibility to run the machine far from electrical peak times with the delayed Start, reducing the electricity bill
- Installing is easy and fast
- Due to the innovative drying concept, you can immediately pick and use the dishes after the cycle ends
- With the average costs level in Europe, the investment depreciation time ranges between 9 and 12 months depending on the machine's use
- According to our laboratory tests, we deem a life span between 12 to 15 years if the machine is used properly

WASH & STORE

STOCK & WASH
DISHWASHERS



1. Doors opening not interfering with equipment aside the machine
2. Thermo-resistant independant glass doors
3. Double-wall construction with thermo-acoustic insulation
4. Chemicals dosing and monitoring station, in a front load drawer
5. Cold-fog drying system
6. Standard steam condenser
7. AISI 316 insulated wash-tank, insulated, with 4 independent self-cleaning pumps
8. Automatic, built-in water softener (no in HI TEMP version)
9. New system of wash and rinse arms, ensuring improved wash results



FEATURES

WASH & STORE changes color at each cycle phase, displaying the actual working temperature. A water change at each cycle stage, grants top hygiene levels. Thanks to the 9 wash-cycles available, just any washing needs are matched: from fragile crystal glasses, to heavily soiled pots.

INNOVATIVE WASH ARMS

The WASH & STORE wash arms keep moving on behalf of your own arms, combining the advantages of the tunnel machines and those of the cycle-machines. With WASH & STORE you can divide the wash areas, according to your needs. Due to the innovative drying concept, you can immediately pick and use the dishes after the cycle ends if needed.

INSTALLATION

Installing a WASH & STORE is easy and fast. Just connect the water circuit drainage and the supply cable and the machine is ready on duty. No steam hoods or vent needed, no floor grids, no water treatment necessary: WASH & STORE is full optional.

Standard applications for the WASH & STORE are: wine-cellars, business restaurants up to 50 covers, family restaurants up to 75 covers, schools, pizzerias, hospital departments, retirement homes, clinics, Police stations and equivalent.



-46%

WATER
CONSUMPTION



-38%

INSTALLED
POWER



-82%

CHEMICAL
CONSUMPTION







-90%

LABOUR

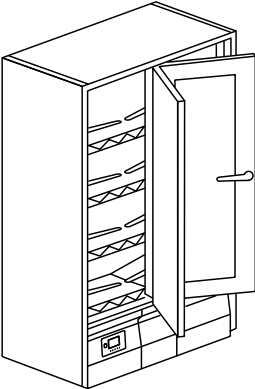
WASH & STORE

STOCK & WASH
DISHWASHERS

Model	Voltage	Capacity	Dimensions	Code
WASH & STORE ELECTRONIC 9 PROGRAMS PATENTED				
	400 V 3N ~ 50 Hz 6,5 kW	 220 H - 320 H*  Ø 210 - Ø 330*  530x325x25 H*	1315x747x2043 H 390 kg or 1315x747x1988 H 390 kg (with wheels)	WASH & STORE WASH & STORE HI TEMP





* Upper level only

OPTIONS

	DA	SC	PS	CONTROL			
Model	380-415 V 3N 50H	220-240 V 3 50 Hz	220-240 V 50 Hz	Water softener	Steam condenser	Drain pump	Substitute remote control panel
WASH & STORE	●	□	□	●	●	●	€
WASH & STORE HI TEMP	●	□	□	----	●	●	€
WASH & STORE DOUBLE FACE	●	□	□	●	●	●	€
WASH & STORE DOUBLE FACE HI TEMP	●	□	□	----	●	●	€

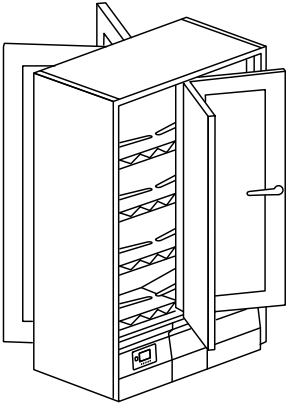
- Standard
- Upon request
- Not available

EAC label upon request







Model	Voltage	Capacity	Dimensions	Code
WASH & STORE DOUBLE FACE	ELECTRONIC 9 PROGRAMS			
PATENTED				
	400 V 3N ~ 50 Hz 6,5 kW	 220 H - 320 H*	1315x810x2043 H 400 kg	WASH & STORE DOUBLE FACE
		 Ø 210 - Ø 330*	or 1315x810x1988 H 400 kg (with wheels)	WASH & STORE DOUBLE FACE HI TEMP
		 530x325x25 H*		

	DDE	DB	D-SAN	FLOAT	ID	DR-F	R
Model	Detergent dispenser	Rinse-Aid dispenser	Sanitizer dispenser	Probes lack det. and rinse aid	Double skin	Cold fog drying system	Wheels
WASH & STORE	●	●	●	●	●	●	€
WASH & STORE HI TEMP	●	●	●	●	●	●	€
WASH & STORE DOUBLE FACE	●	●	●	●	●	●	€
WASH & STORE DOUBLE FACE HI TEMP	●	●	●	●	●	●	€

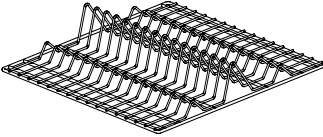

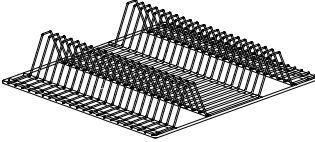

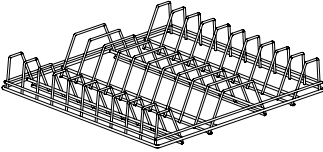

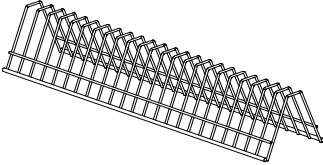
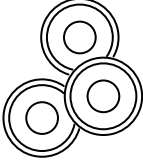
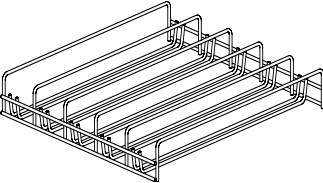
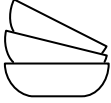

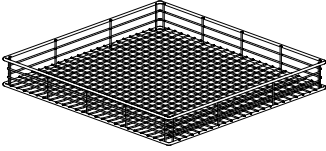

WASH & STORE With water softener, water supply max 35 °C - Water hardness < 20 °f

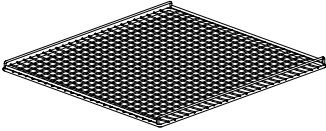
WASH & STORE HI TEMP Without water softener, water supply max 65 °C - Max water hardness 5 °f, if higher an external water softener is required

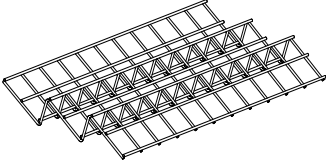
Option compatibility to be confirmed by the manufacturer after verification

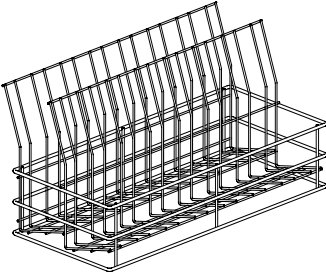
	Description	Capacity	Dimensions	Code	
	RACK FOR PLATES AND TRAYS	30 pcs 15 pcs	 210 <math><\varnothing></math> 240 250 <math><\varnothing></math> 330* max depth 40  530x325x25 H*	590071	
	RACK FOR FLAT DISHES	42 pcs	 250x15 max depth 15	590072	
	RACK FOR PLATES	20 pcs 10 pcs 10 pcs	 210 <math><\varnothing></math> 240 250 <math><\varnothing></math> 330* max depth 70  530x325x25 H*	590124	
	SAUCER SUPPORT in combination with 590074 or 590075	23 pcs	 $\varnothing < 240$	590078	
	BOWLS SUPPORT in combination with 590074	8 pcs 20 pcs	 \varnothing 235 depth 100 \varnothing 110 depth 50	590128	

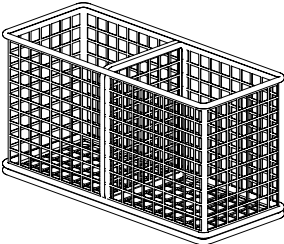
* upper level only

	Description	Capacity	Dimensions	Code	
	RACK FOR MUGS AND LOW GLASS SET	25 pcs	 Ø 100	590074	
	RACK FOR MUGS AND LOW GLASS SET	25 pcs	 Ø 100	590075	
	CUPS SUPPORT for 590074 / 590075 in combination with 590074	24 pcs	 Ø < 55	590076	
	SUPPORT FOR TALL GLASSES in combination with 590075	8 pcs	 Ø 100	590077	
	CUTLERY SUPPORT in combination with 590074 or 590075	30 pcs		590080	



The RK COMPACT dishwashers line has been designed to satisfy the demand of medium and small restaurants. These machines combine compact

dimensions with high performances. We now introduce the new line with electromechanical panel to enhance the usability.

CUSTOMIZABLE AND REVERSIBLE

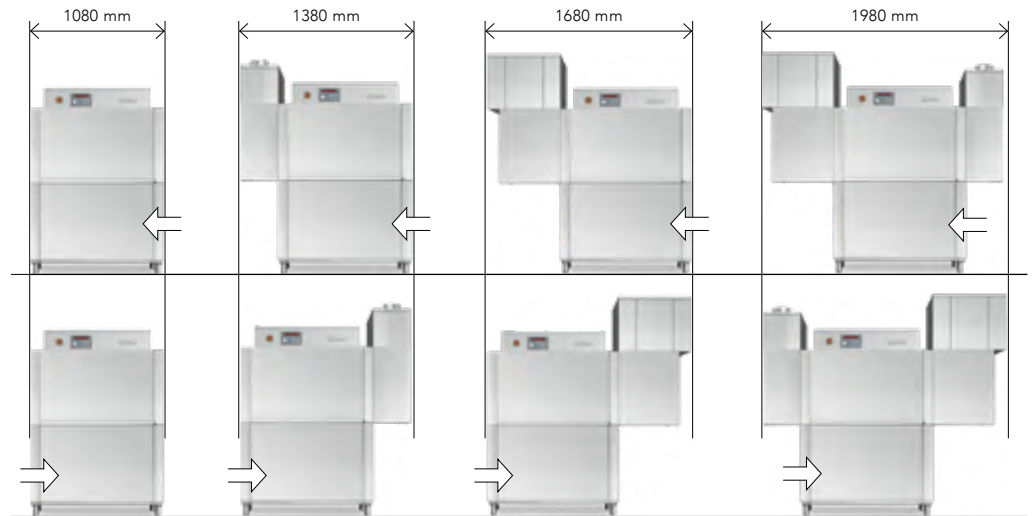

FEATURES

- Sloped radial wash tanks to help emptying the tanks
- Self-cleaning vertical wash pumps, protected from electrical overloads
- Traction system with built-in clutch preventing derailment
- AISI 304 stainless steel boilers, fully insulated to reduce thermal losses
- Simple and intuitive touch control panel or electromechanical panel
- S/S wash and rinse arms. These are removable without using any tool
- S/S surface filters on every tank, easily removable without detaching wash arms
- Insulated double skin door, counterbalanced, equipped with anti-drop safety system
- DRIVE speed variator with 3 speeds on the electromechanical versions and 5 speeds on the electronic versions
- Autotimer in order to switch off the rack conveyor motor as well as other machine's options (electronic version)
- Economizers to allow operation only when the rack is detected on that specific area
- Pressure reducer, to stabilize the water pressure and grant an optimal final rinse
- Non-return valve to prevent the water backflow
- Linear or 90° arc drying module (Option)
- Sanitization system which includes the sanitizing product dispensers (Option for electronic version only)
- Heat recovery in case of cold water inlet (8-15 °C) (Option)

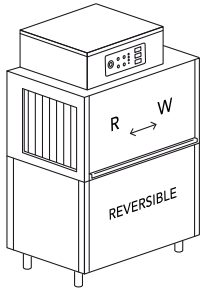
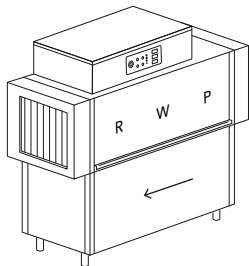





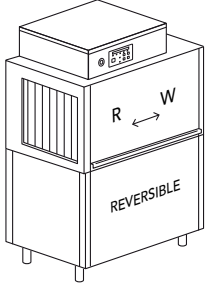

Model	Voltage	Capacity	Dimensions	Code
RK 1010 3 SPEEDS				
	<p>RACK EQUIPMENT</p> <ul style="list-style-type: none"> 1 X C40 1 X C43 1 X C44 1 X C47 	<p>400 V 3N ~ 50 Hz 19,1 kW</p>	<p>Ø 450</p> <p>500x500</p> <p>66* - 100 racks / h</p>	<p>1080 x 715 1690/1900 H 210 kg</p> <p>GN 1/1</p> <p>530x325x25 H</p> <p>RK 1010</p>
RK 1640 3 SPEEDS				
	<p>RACK EQUIPMENT</p> <ul style="list-style-type: none"> 1 X C40 1 X C43 1 X C44 1 X C47 	<p>400 V 3N ~ 50 Hz 23,6 kW</p>	<p>Ø 450</p> <p>500x500</p> <p>86* - 150 racks / h</p>	<p>1880 x 715 1690/1900 H 270 kg</p> <p>GN 1/1</p> <p>530x325x25 H</p> <p>RK 1640</p>

P Prewash

W Wash

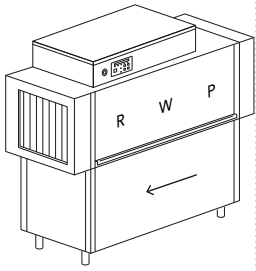
R Single rinse

* Productivity according to DIN SPEC 10534 regulation (contact time)

Model	Voltage	Capacity	Dimensions	Code
RK 1010 E ELECTRONIC 5 SPEEDS 	400 V 3N ~ 50 Hz 19,1 kW	 Ø 450  500x500 66* - 100 racks / h	1080 x 715 1565/1900 H 210 kg  530x325x25 H	RK 1010 E
RK 1640 E ELECTRONIC 5 SPEEDS 	400 V 3N ~ 50 Hz 23,6 kW	 Ø 450  500x500 86* - 150 racks / h	1880 x 715 1565/1900 H 270 kg  530x325x25 H	RK 1640 E

OPTIONS

Model	220-240V 3.50 Hz	380-415V 3N 50 Hz	60 Hz	XP Extra power	PRE DOS KROMO disp. connections	DDE-GROUP Dispensers kit	DOS/S Dispenser with probe	Rinse econom.	Pressure reducer	High speed	DRIVE Smart drive	AUTOTIMER Autotimer	Soft Touch panel
RK 1010	€	●	+3%	€	●	€	€	●	●	----	●	----	----
RK 1640	€	●	+3%	€	●	€	€	●	●	----	●	----	----
RK 1010 E*	€	●	+3%	€	●	€	€	●	●	€	●	●	●
RK 1640 E*	€	●	+3%	€	●	€	€	●	●	----	●	●	●

● Standard

---- Not available

E Electronic panel

* Construction according to UL-NSF standards upon request

KDRA924 Available only without KM22 - KM23 on entry

KM22 - KM23 Available on entry or exit connections, one per layout

DDE-GROUP Both detergent (with probe) and rinse-aid dispensers included

DOS/S For detergent dispenser only

HIGH SPEED Extra power included. Hot water inlet 55°C

AUTOTIMER Functioning only when combined with KDR24, KDRA924, KSC5, KHR5

Water supply 55 °C. Water hardness min 2°f - max 8°f (if higher, an external water softener is required).
We recommend to install the machine in a well ventilated room, with a properly sized steam exhausting system.

Construction according to UL-NSF standards upon request

EAC label upon request

Option compatibility to be confirmed by the manufacturer after verification

AVAILABLE ARCS:

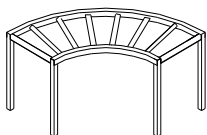

K21
1300x1300x860 H
90° roller arc with tank

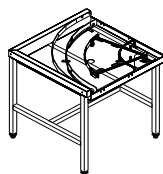

KM22
850x850x885 H
90° mechanized arc
(clockwise/counter-clockwise)

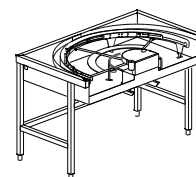

KM23
850x1500x885 H
180° mechanized arc
(clockwise/counter-clockwise)

	BT	DVGW	DWI/T	DWI	PI	PAP	SAN	PAP-SAN	DIV	KSC5	KHR5	KDR24	KDRA924	K16AC
Model	Break tank	DVGW	Tank insulation	Thermoacoustic insulation	S/S pumps	Booster pump	Sanitization system	Booster pump sanitiz.	Price for division	Steam cond.	Heat recovery	Dryer	Dryer 90° arc	Splash guard
RK 1010	----	----	€	€	€	€	----	----	€	€	€	€	€	€
RK 1640	----	----	€	€	€	€	----	----	€	€	€	€	€	●
RK 1010 E	€	€	€	€	€	€	€	€	€	€	€	€	€	€
RK 1640 E	€	€	€	€	€	€	€	€	€	€	€	€	€	●

BT Booster pump included

DVGW Not available with heat recovery and steam condenser
Components prescribed by DVGW on request (check option compatibility with the manufacturer)

DWI - DWI/T Recommended with KHR5

PI Available with 50 Hz frequency only

SAN Including dosing system for sanitizing product

XP In case of cold water supply for rinse 8 °C 55 °C, and without any heat recovery, the extra power option is mandatory.
In case of cold water supply for rinse 8-15 °C, we recommend the heat recovery option.

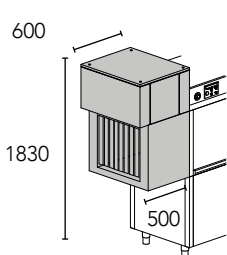

KDR24

4,5 kW

Dryer

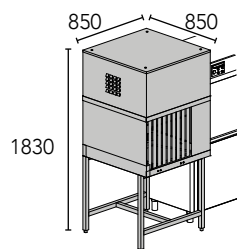

KDRA924

4,5 kW

Dryer with mechanized arc 90° to be used with original KROMO racks only

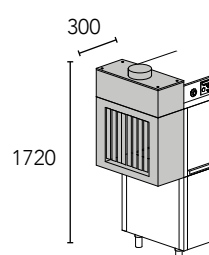

KSC5

Steam condenser

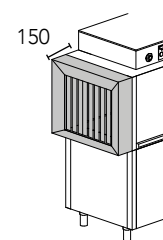

KHR5

Compact heat recovery

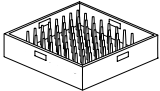
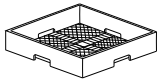
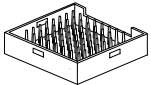
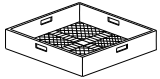
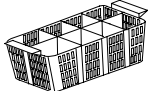
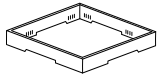
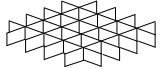
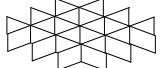

K16AC

Splash guard

	Description	Capacity	Dimensions	Code
	PLATE BASKET	18 plates	500x500x105 H	C 40
	NARROW MESH CUTLERY BASKET		500x500x106 H	C 41
	TRAYS BASKET	6 pcs, max. depth 25 mm	500x500x105 H	C 43
	LARGE MESH BASKET	For glasses	500x500x105 H	C 44
	CUTLERY BASKET		490x180x140 H	C 47
	HOLDER FOR GLASS SUPPORT	For glass support (C112-C113-C114)	500x500x50 H	C 111
	GLASS SUPPORT	5x5 Glass Ø 87 mm (C111)	500x500x50 H	C 112
	GLASS SUPPORT	4x4 Glass Ø 110 mm (C111)	500x500x50 H	C 113
	GLASS SUPPORT	6x6 Glass Ø 72 mm (C111)	500x500x50 H	C 114
	FLEXIBLE SHOWER complete with mixing group and lever tap, to be fixed to the wall		1000 H	K 1
	FLEXIBLE SHOWER complete with mixing group and lever tap, to be fixed to the wall and intermediate tap		1000 H	K 1HR

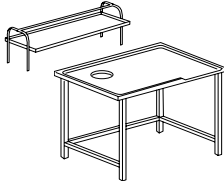
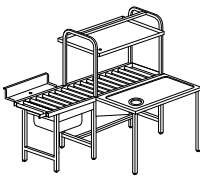
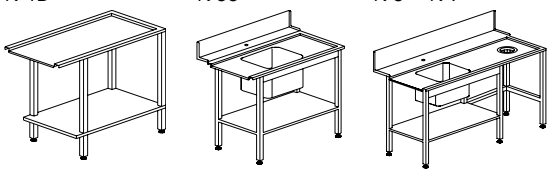
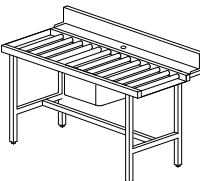
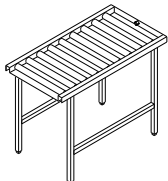
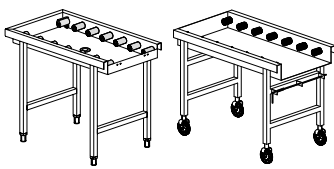
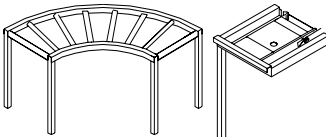
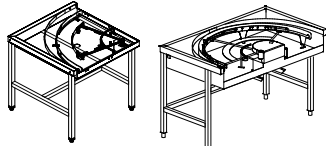
	Description	Capacity	Dimensions	Code
	SHELF		1515x620x660 H 2315x620x660 H	K 7M16 * ▫ K 7M24 * ▫
	GRADING TABLE WITH RUBBER RING AND HOLE	Special dimensions upon request	1600x1000x850 H 2400x1000x850 H	K 7A/1600 * ▫ K 7A/2400 * ▫
	MECHANIZED GRADING TABLE With mechanized basket advancement system	1 waste hole 2 waste holes	1800x1240x1525 H 2400x1240x1525 H	K M7/1800 * ▫ K M7/2400 * ▫
		<p>K 4B K 55 K 8 - K 9</p> <p>Sink 500x400x270 H Sink 500x400x270 H</p>	Standard rubber ring Standard rubber ring	1200x590x860 H 1200x730x860 H 1500x730x860 H 1800x730x860 H
	ROLLER TABLE + sink, right or left version Sink 500x400x270 H		1600x730x860 H	K 195 ▫
	LINEAR ROLLER TABLE WITH TANK	Option end microswitch	1100x650x860 H 1600x650x860 H 2100x650x860 H	K 19 * ▫ K 19/B * ▫ K 19/C * ▫ K 18
	<p>K 19/1 - K 19/1A K 20/1 - K 20/1A</p> <p>LINEAR ROLLER TABLE WITH TANK complete with end microswitch</p>	Not compatible with same references Not on 180°arcs To be connected to KM 23 only and to dryer on 180°	1100x650x860 H 1600x650x860 H 1150x650x860 H 1650x650x860 H	K 19/1 ▫ K 19/1A ▫ K 20/1 ▫ K 20/1A ▫
	<p>90°roller arc with tank (exit only with roller table)</p> <p>Angle loading table complete with basket pull-through system</p>	Optional connection to prewash tables	1300x1300x860 H 700x610x820 H	K 21 * K 25
	<p>90° MECHANIZED ARC (clockwise/counter-clockwise) not available at the entry on K10 version</p> <p>180° MECHANIZED ARC (clockwise/counter-clockwise)</p>	Available on entry or exit connections, one per layout. To be used with original KROMO racks only	850x850x885 H 850x1500x885 H	KM 22 * KM 23 *

* Wooden cage +2% minimum + € / ▫ Special dimensions for tables upon request / Tables shown in right-to-left version
We strongly recommend the presence of a roller table with end microswitch at the exit of our rack type machines for a correct operation



KROMO presents the RK UP line of rack conveyor dishwashers with double rinse: a range of models with multiple accessories to offer tailor-made solutions for any customer needs. Thanks to the efficient pre-rinse and rinse system, we have achieved a radical reduction in water consumption, up to using

approximately one liter of water per basket only. Pre-rinse saves water, rinse-aid and electricity because the water used for rinsing is collected and sent to the pre-rinse arms. This result, besides respecting the environment, significantly saves chemicals and reduces the need for energy.



CONTROL PANEL

The RK UP control panel with IPX5 membrane keyboard, allows both technicians and users to obtain comprehensive and detailed information on the machine operation. Its display with scrolling text provides data about the current status of the machine, such as boiler and tank temperatures, main alert codes and various programmable settings. The user-friendly control board, combined with the clear set of information provided to the user, make of KROMO display a reliable and effective control device for our machine.











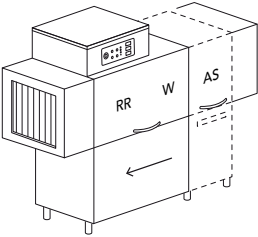

FEATURES

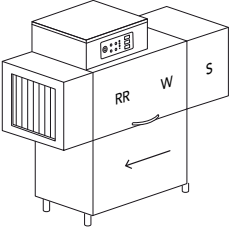
STANDARD

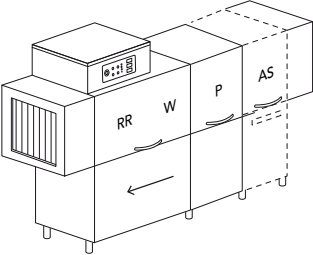
- Electronic panel with IPX5 membrane keyboard on electronic versions or electromechanical control panel in electromechanical versions
- Double-skin, insulated and counterbalanced doors, equipped with anti-drop safety system
- Ergonomic handles
- Thermo barrier system for comfort in use
- Acid proof AISI 316 stainless steel radial wash tanks
- CLEAN+ filters
- Self-cleaning vertical wash pumps, protected from electrical overloads
- Wash arms ALL-IN-1
- CPF System
- Side traction system with built-in clutch
- DRIVE speed variator with 3 speeds on the electromechanical versions and 5 speeds on the electronic versions
- Use economizer
- Acid proof AISI 316 stainless steel boilers, fully insulated to reduce thermal loss
- Autotimer switching off the rack conveyor motor and all electrical options after a preset lapse of inactivity
- Improved double rinse RR, more effective and with limited consumptions

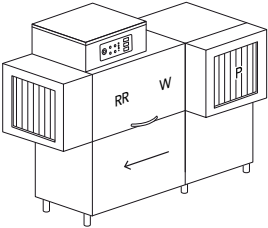
OPTIONS

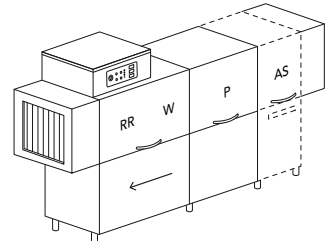
- Linear and 90°/180° corner drying modules, power 4,5 kW or 9 kW (double skin dryer available for linear models only)
- Steam condenser (KSC10)
- Two models of heat recovery to be chosen according to the type of machine (compact or with integrated heat pump)
- Detergent dispenser with probe or dispensers kit
- Booster pump
- Hydraulic security system Break Tank
- Extra power for the boiler
- Thermal and acoustic insulation
- Stainless steel pumps
- Centralized drain 1-DRAIN
- Delivery in 2 or more parts to facilitate handling
- Machine sanitization also with dedicated booster pump

Model		Voltage	Capacity	Dimensions	Code	
RK 1040 3 SPEEDS		RACK EQUIPMENT 1 X C40 1 X C43 1 X C44 1 X C47	400 V 3N ~ 50 Hz 19,90 kW	Ø 450  500x500 80* - 112 racks / h	1900x805 1830/2120 H 245 kg AS + 450 mm  530x325x25H	RK 1040 RK 1040 AS
RK 1440 3 SPEEDS		RACK EQUIPMENT 1 X C40 1 X C43 1 X C44 1 X C47	400 V 3N ~ 50 Hz 20,60 kW	Ø 450  500x500 93* - 144 racks / h	2100x805 1830/2120 H 270 kg GN 1/1 530x325x25H	RK 1440
RK 1840 3 SPEEDS		RACK EQUIPMENT 1 X C40 1 X C43 1 X C44 1 X C47	400 V 3N ~ 50 Hz 23,82 kW	Ø 450  500x500 115* - 192 racks / h	2500x805 1830/2120 H 355 kg AS + 450 mm  530x325x25H	RK 1840 RK 1840 AS
RK 1840-K10 3 SPEEDS - CORNER PREWASH		RACK EQUIPMENT 1 X C40 1 X C43/B 1 X C44 1 X C47	400 V 3N ~ 50 Hz 23,82 kW	Ø 450  500x500 115 - 192 racks / h	2225x985 1830/2120 H 355 kg GN 1/1 530x325x25H	RK 1840-K10
RK 2440 3 SPEEDS		RACK EQUIPMENT 1 X C40 1 X C43 1 X C44 1 X C47	400 V 3N ~ 50 Hz 28,10 kW	Ø 450  500x500 132* - 240 racks / h	2800x805 1830/2120 H 395 kg AS + 450 mm  530x325x25H	RK 2440 RK 2440 AS

P Prewash
W Wash
RR Pre-rinse + rinse

K10 Corner prewash
AS Automatic shower with filter drawer +450 mm
S Soaking

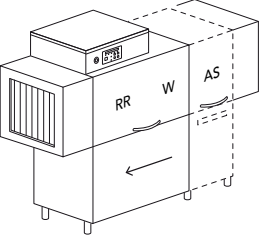
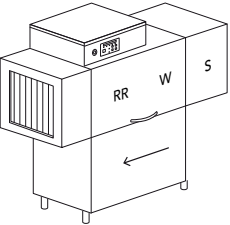
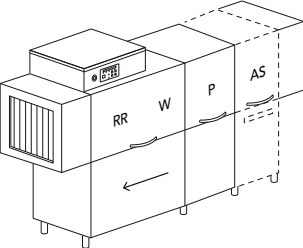
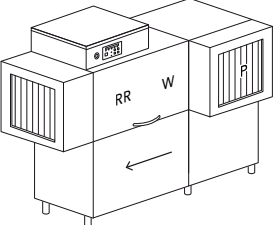
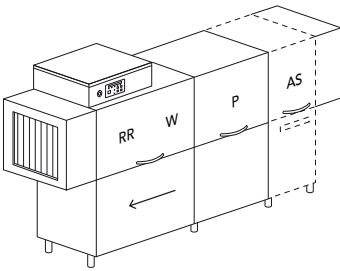
Model	Voltage	Capacity	Dimensions	Code	
RK 1040 E 5 SPEEDS					
	<p>RACK EQUIPMENT 1 X C40 1 X C43 1 X C44 1 X C47</p>	<p>400 V 3N ~ 50 Hz 19,90 kW</p>	<p>Ø 450</p> <p>500x500</p> <p>80* - 112 racks / h</p>	<p>1900x805 1830/2120 H 245 kg</p> <p>AS + 450 mm</p> <p>GN 1/1</p> <p>530x325x25H</p>	<p>RK 1040 E</p> <p>RK 1040 E AS</p>
RK 1440 E 5 SPEEDS					
	<p>RACK EQUIPMENT 1 X C40 1 X C43 1 X C44 1 X C47</p>	<p>400 V 3N ~ 50 Hz 20,60 kW</p>	<p>Ø 450</p> <p>500x500</p> <p>93* - 144 racks / h</p>	<p>2100x805 1830/2120 H 270 kg</p> <p>GN 1/1</p> <p>530x325x25H</p>	<p>RK 1440 E</p>
RK 1840 E 5 SPEEDS					
	<p>RACK EQUIPMENT 1 X C40 1 X C43 1 X C44 1 X C47</p>	<p>400 V 3N ~ 50 Hz 23,82 kW</p>	<p>Ø 450</p> <p>500x500</p> <p>115* - 192 racks / h</p>	<p>2500x805 1830/2120 H 355 kg</p> <p>AS + 450 mm</p> <p>GN 1/1</p> <p>530x325x25H</p>	<p>RK 1840 E</p> <p>RK 1840 E AS</p>
RK 1840E-K10 5 SPEEDS - CORNER PREWASH					
	<p>RACK EQUIPMENT 1 X C40 1 X C43/B 1 X C44 1 X C47</p>	<p>400 V 3N ~ 50 Hz 23,82 kW</p>	<p>Ø 450</p> <p>500x500</p> <p>115 - 192 racks / h</p>	<p>2225x985 1830/2120 H 355 kg</p> <p>GN 1/1</p> <p>530x325x25H</p>	<p>RK 1840E-K10</p>
RK 2440 E 5 SPEEDS					
	<p>RACK EQUIPMENT 1 X C40 1 X C43 1 X C44 1 X C47</p>	<p>400 V 3N ~ 50 Hz 28,10 kW</p>	<p>Ø 450</p> <p>500x500</p> <p>132* - 240 racks / h</p>	<p>2800x805 1830/2120 H 395 kg</p> <p>AS + 450 mm</p> <p>GN 1/1</p> <p>530x325x25H</p>	<p>RK 2440 E</p> <p>RK 2440 E AS</p>

* Productivity according to DIN SPEC 10534 regulation (contact time)

OPTIONS

Model	220-240 V3 50Hz	380-415 V 3N 50 Hz	60Hz	PRE DOS	DDE-GROUP	DOS/S	SAN	PAP-SAN	KSC10	KHR10	KHR20	KHRP40
				KROMO disp. connections	Dispensers kit	Dispenser with probe	Sanitization system	Booster pump sanitiz.	Steam cond.	Heat recovery	Heat recovery	Heat recovery
RK 1040	€	●	+3%	●	€	€	----	----	€	€	----	----
RK 1040 AS	€	●	+3%	●	€	€	----	----	€	€	----	----
RK 1040 E*	€	●	+3%	●	€	€	€	€	€	€	----	€
RK 1040 E AS	€	●	+3%	●	€	€	€	€	€	€	----	€
RK 1440	€	●	+3%	●	€	€	----	----	€	€	----	----
RK 1440 E	€	●	+3%	●	€	€	€	€	€	€	----	€
RK 1840	€	●	+3%	●	€	€	----	----	€	€	€	----
RK 1840 AS	€	●	+3%	●	€	€	----	----	€	€	€	----
RK 1840 E	€	●	+3%	●	€	€	€	€	€	€	€	€
RK 1840 E AS	€	●	+3%	●	€	€	€	●	€	€	€	€
RK 1840-K10	€	●	+3%	●	€	€	----	----	€	€	----	€
RK 1840E-K10	€	●	+3%	●	€	€	€	€	€	€	----	€+
RK 2440	€	●	+3%	●	€	€	----	----	€	€	€	----
RK 2440 AS	€	●	+3%	●	€	€	----	----	€	€	€	----
RK 2440 E*	€	●	+3%	●	€	€	€	€	€	€	€	€
RK 2440 E AS	€	●	+3%	●	€	€	€	●	€	€	€	€

● Standard

---- Not available

E Settable electronic panel

KHRP40 Available with 400 V 3N 50 Hz frequency only

KHR10 - KHR20 - KHRP40 In case of cold water supply for rinse (8-15 °C), we recommend to install the heat recovery system optional. Extra power included

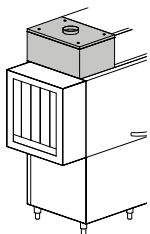

KSC10
Steam condenser

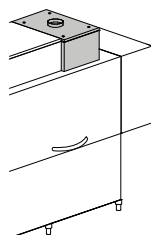

KHR10
Compact heat recovery

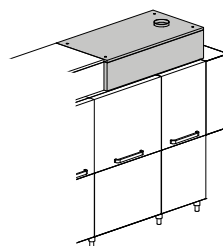

KHR20
heat recovery

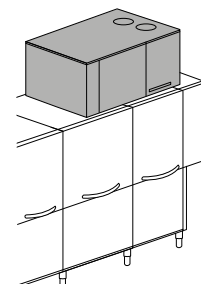

KHRP40
Heat recovery with heat pump

	DWI	PAP	DRIVE	AUTOTIMER	BT	DVGW	DWI / T	XP	DIV	PI	1-DRAIN
Model	Thermo acoustic insulation	Booster pump	Smart drive	Autotimer	Break tank	DVGW	Tank insulation	Extra power	Price for division	S/S pumps	Centralized drain
RK 1040	€	€	●	----	----	----	€	€	€	€	€
RK 1040 AS	€	€	●	----	----	----	€	€	€	€	€
RK 1040 E*	€	€	●	●	€	€	€	€	€	€	€
RK 1040 E AS	€	€	●	●	€	€	€	€	€	€	€
RK 1440	€	€	●	----	----	----	€	€	€	€	€
RK 1440 E	€	€	●	●	€	€	€	€	€	€	€
RK 1840	€	€	●	----	----	----	€	€	€	€	€
RK 1840 AS	€	€	●	----	----	----	€	€	€	€	€
RK 1840 E	€	€	●	●	€	€	€	€	€	€	€
RK 1840 E AS	€	€	●	●	€	€	€	€	€	€	€
RK 1840-K10	€	€	●	----	----	----	€	€	€	€	€
RK 1840E-K10	€	€	●	●	€	€	€	€	€	€	€
RK 2440	€	€	●	----	----	----	€	€	€	€	€
RK 2440 AS	€	€	●	----	----	----	€	€	€	€	€
RK 2440 E*	€	€	●	●	€	€	€	€	€	€	€
RK 2440 E AS	€	€	●	●	€	€	€	€	€	€	€

+ Not available for K10 version if the machine is next to the wall

***** Construction according to UL-NSF standards upon request

DDE-GROUP Both detergent (with probe) and rinse-aid dispensers included

DOS/S For detergent dispenser only

SAN Including dosing system for sanitizing product

DWI Insulation option for the tunnel only, dryer excluded. Shelf dryer can be insulated upon request. Recommended with KHR10 – KHR20 – KHRP40

DRIVE Check voltage compatibility

BT Booster pump

DIV For models RK 1040, RK 1040 E, RK 1440, RK 1440 E, Only splash guards removable

PI Available with 50 Hz. frequency only. Not available for AS module

DVGW Not available with heat recovery and steam condenser
Components prescribed by DVGW on request (check option compatibility with the manufacturer)

XP In case of cold water supply for rinse 8 °C 55 °C, and without any heat recovery, the extra power option is mandatory
With osmotic water supply and electrical conductivity lower than 200 microsiemens, it is mandatory to install a stainless steel heat exchanger

We recommend to install the machine in a well ventilated room, with a properly sized steam exhausting system

Peak-cut connect upon request

Water supply 55 °C. Water hardness min 2°f - max 8°f (if higher, an external water softener is required)

Option compatibility to be confirmed by the manufacturer after verification

OPTIONS

	KDR64	KDR69	KDR94	KDR99
Model	Dryer + 400 mm / 4,5 kW	Dryer + 400 mm / 9 kW	Dryer + 700 mm / 4,5 kW	Dryer + 700 mm / 9 kW
RK 1040	€	€	€	€
RK 1040 AS	€	€	€	€
RK 1040 E*	€	€	€	€
RK 1040 E AS	€	€	€	€
RK 1440	€	€	€	€
RK 1440 E	€	€	€	€
RK 1840	€	€	€	€
RK 1840 AS	€	€	€	€
RK 1840 E	€	€	€	€
RK 1840 E AS	€	€	€	€
RK 1840-K10	€	€	€	€
RK 1840E-K10	€	€	€	€
RK 2440	€	€	€	€
RK 2440 AS	€	€	€	€
RK 2440 E*	€	€	€	€
RK 2440 E AS	€	€	€	€

ID Recommended for KDR69 - KDR99. Not available for corner dryers

***** Construction according to UL-NSF standards upon request

KDR64 - KDR94 - KDRA94MC - KDRA184MC With the models RK 1840 - RK 2440 verify feasibility with manufacturer

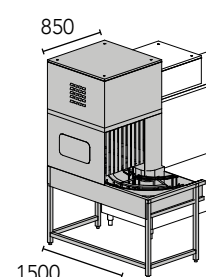
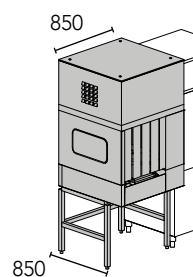
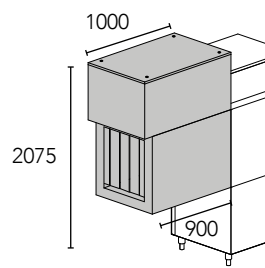
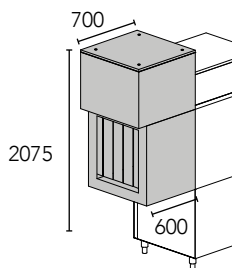

KDR64 4,5 kW Electric
KDR69 9 kW Electric
Dryer

KDR94 4,5 kW Electric
KDR99 9 kW Electric
Dryer

KDRA94MC 4,5 kW Electric
KDRA99MC 9 kW Electric
Dryer with mechanized arc 90°
to be used with original KROMO
racks only

KDRA184MC 4,5 kW Electric
KDRA189MC 9 kW Electric
Dryer with mechanized arc 180°
to be used with original KROMO
racks only

	KDRA94MC	KDRA99MC	KDRA184MC	KDRA189MC	ID
Model	Mechanized dryer 90° arc 4,5 kW	Mechanized dryer 90° arc 9 kW	Mechanized dryer 180° arc 4,5 kW	Mechanized dryer 180° arc 9 kW	Double skin for dryer
RK 1040	€	€	€	€	€
RK 1040 AS	€	€	€	€	€
RK 1040 E*	€	€	€	€	€
RK 1040 E AS	€	€	€	€	€
RK 1440	€	€	€	€	€
RK 1440 E	€	€	€	€	€
RK 1840	€	€	€	€	€
RK 1840 AS	€	€	€	€	€
RK 1840 E	€	€	€	€	€
RK 1840 E AS	€	€	€	€	€
RK 1840-K10	€	€	€	€	€
RK 1840E-K10	€	€	€	€	€
RK 2440	€	€	€	€	€
RK 2440 AS	€	€	€	€	€
RK 2440 E*	€	€	€	€	€
RK 2440 E AS	€	€	€	€	€

KM22 - KM23 Available on entry or exit connections, one per layout

KDRA184MC - KDRA189MC Mandatory division

KDRA94MC - KDRA99MC - KDRA184MC - KDRA189MC Available only without KM22 - KM23 on entry

AVAILABLE ARCS:

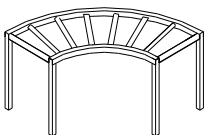

K21
1300x1300x860 H
90° roller arc with tank

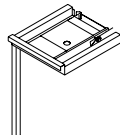



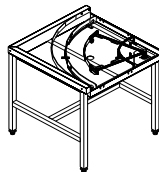

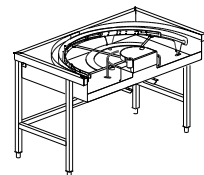

K25
700x610x820 H
Angle loading table complete
with basket
pull-through system

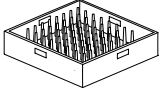
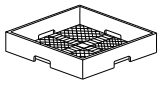
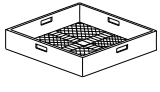
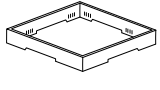
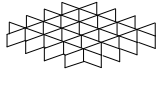
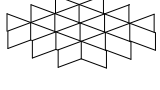

KM22
850x850x885 H
90° mechanized arc
(clockwise/counter-clockwise)
to be used with original KROMO racks
only

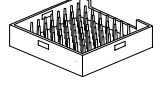
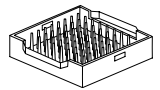

KM23
850x1500x885 H
180° mechanized arc
(clockwise/counter-clockwise)
to be used with original
KROMO racks only

	Description	Capacity	Dimensions	Code	
	PLATE BASKET	18 plates	500x500x105 H	C 40	
	NARROW MESH CUTLERY BASKET		500x500x106 H	C 41	
	LARGE MESH BASKET	For glasses	500x500x105 H	C 44	
	HOLDER FOR GLASS SUPPORT	For glass support (C112-C113-C114)	500x500x50 H	C 111	
	GLASS SUPPORT	5x5 Glass Ø 87 mm (C111)	500x500x50 H	C 112	
	GLASS SUPPORT	4x4 Glass Ø 110 mm (C111)	500x500x50 H	C 113	
	GLASS SUPPORT	6x6 Glass Ø 72 mm (C111)	500x500x50 H	C 114	
	TRAYS BASKET	8 pcs, max. depth 25 mm	500x500x105 H	C 43	
	GASTRONORM TRAYS BASKET GN 1/1	6 pcs, max. depth 25 mm	500x500x105 H	C 43/B	
	CUTLERY BASKET		490x180x140 H	C 47	
	FLEXIBLE SHOWER complete with mixing group and lever tap, to be fixed to the wall		1000 H	K 1	
	FLEXIBLE SHOWER complete with mixing group and lever tap, to be fixed to the wall and intermediate tap		1000 H	K 1HR	

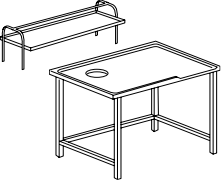
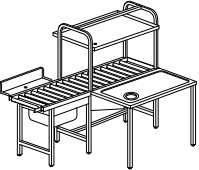
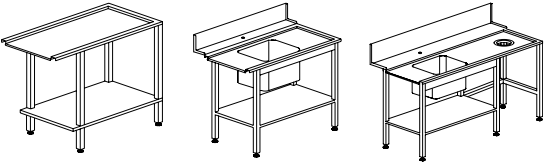
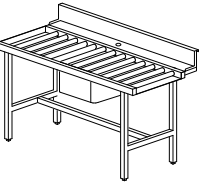
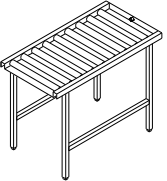
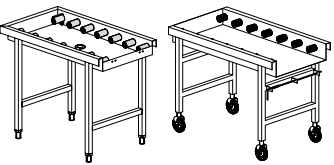
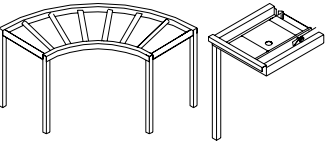
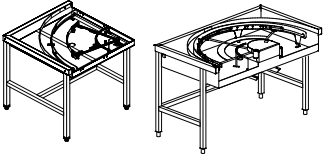
	Description	Capacity	Dimensions	Code	
	SHELF		1515x620x660 H 2315x620x660 H	K 7M16 * ▣ K 7M24 * ▣	
	GRADING TABLE WITH RUBBER RING AND HOLE	Special dimensions upon request	1600x1000x850 H 2400x1000x850 H	K 7A/1600 * ▣ K 7A/2400 * ▣	
	MECHANIZED GRADING TABLE With mechanized basket advancement system	1 waste hole	1800x1240x1525 H	K M7/1800 * ▣	
		2 waste holes	2400x1240x1525 H	K M7/2400 * ▣	
<p data-bbox="121 768 169 790">K 4B</p> <p data-bbox="312 768 360 790">K 55</p> <p data-bbox="488 768 584 790">K 8 - K 9</p>  <p data-bbox="312 965 472 1014">Sink 500x400x270 H</p> <p data-bbox="488 965 647 1014">Sink 500x400x270 H</p>			1200x590x860 H 1200x730x860 H 1500x730x860 H 1800x730x860 H	K 4B ▣ K 55 ▣ K 8 ▣ K 9 ▣	
	ROLLER TABLE + sink, right or left version		1600x730x860 H	K 195 ▣	
	LINEAR ROLLER TABLE WITH TANK	Option end microswitch	1100x650x860 H 1600x650x860 H 2100x650x860 H	K 19 * ▣ K 19/B * ▣ K 19/C * ▣ K 18	
<p data-bbox="92 1451 236 1473">K 19/1 - K 19/1A</p> <p data-bbox="260 1451 403 1473">K 20/1 - K 20/1A</p> 	LINEAR ROLLER TABLE WITH TANK complete with end microswitch	Not compatible with same references Not on 180° arcs To be connected to KM 23 only and to dryer on 180°	1100x650x860 H 1600x650x860 H 1150x650x860 H 1650x650x860 H	K 19/1 ▣ K 19/1A ▣ K 20/1 ▣ K 20/1A ▣	
	90° roller arc with tank (exit only with roller table) Angle loading table complete with basket pull-through system	Optional connection to prewash tables	1300x1300x860 H 700x610x820 H	K 21 * K 25	
	90° MECHANIZED ARC (clockwise/counter-clockwise) not available at the entry on K10 version 180° mechanized arc (clockwise/counter-clockwise)	KROMO racks only	850x850x885 H 850x1500x885 H	KM 22 * KM 23 *	

* Wooden cage +2% minimum + € / ▣ Special dimensions for tables upon request / Tables shown in right-to-left version
We strongly recommend the presence of a roller table with end microswitch at the exit of our rack type machines for a correct operation



The KROMO rack-type dishwashers are the ideal answer for demanding customers such as restaurants, canteens, schools, hospitals, hotel of any size, cruise-liners, caterers and airports. Models equipped with reinforced double rinse on an independent module. Wash and rinse areas are completely separated, this avoids any interference between detergent and rinse aid, increasing its effectiveness and achieving a consequent reduction in consumption.

The wider distance between the pre-rinse arms also avoids the contamination in the rinse zone. Thanks to the renewed double rinsing system, we achieved a radical reduction of water consumption down to less than one liter per basket: far below the best market standards. This result, showing the green heart of the RK LUX line, allows significant savings on chemicals and electricity bills.



FEATURES

STANDARD

- SMART DRIVE advancement system with 5 speeds
- IPX5 electronic board
- TFT 5.7" display and soft touch keyboard
- Frequently used keys shortcut and menu language setting
- Constant monitoring of key operating parameters with integrated HACCP interface
- Alarms and events report
- ECO-DET Detergent economizer
- Reinforced double rinse 2R+, more effective and with limited consumptions
- 1-DRAIN Centralized drain
- Preset configuration to install our KROMO dispensers
- Water, energy consumptions and working time read out
- Preset maintenance reminder
- Possible working modes for dryer unit: all off, only fan or total power + fan (4,5 kW or 9 kW, maximum power according to the model)
- AISI 316 stainless steel tanks and boilers

OPTIONS

- Linear and 90°/180° corner drying modules, power 4,5 kW or 9 kW (double skin door available only for linear models) and steam dryer available
- Steam condenser (KSC10) or 3 heat recovery systems, to be chosen according to the type of machine (XP included)
- Detergent dispenser with probe or dispensers kit
- Booster pump
- Hydraulic security system Break Tank
- Extra power for boiler
- Thermal and acoustic insulation
- Insulated tanks
- Stainless steel pumps
- Machine sanitization (with dedicated booster pump upon request)
- Delivery in 2 or more parts for easy handling
- CONNECTIVITY remote control compliant with the HACCP norms

CONNECTIVITY 4.0 & APP

WHEREVER YOU ARE...
YOUR DISHWASHER, JUST A CLICK AWAY

You will be constantly connected to the machine to monitor the work phases, review any eventual alarm and configure remotely the operating parameters according to your needs. Compliant with HACCP norms. Thanks to our brand new App, you will have access to connected machines and all commercial and technical documentation.

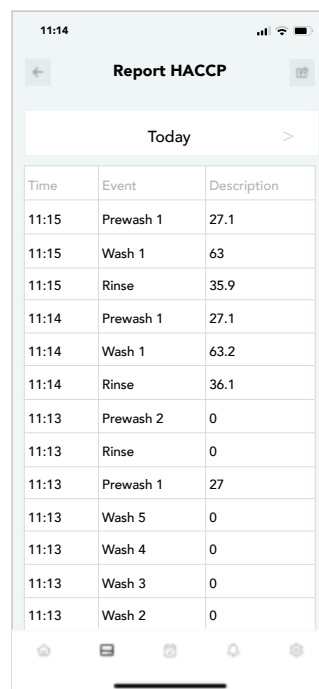
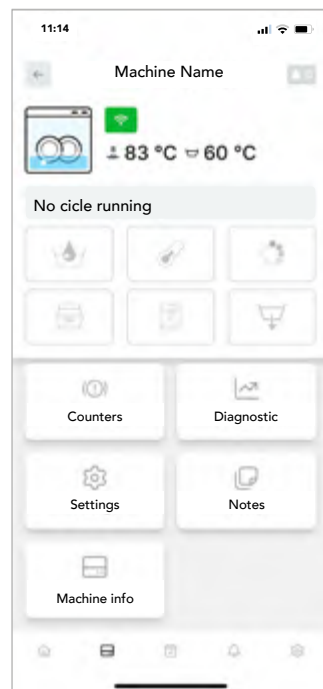

View all the working parameters and event records, working hours and any problem at any time.



In case of problem, the machine promptly alerts you. The technician can intervene remotely to solve the problem or anticipate the needed parts for an on-site intervention.



A daily activity report is available with all the events related to the dishwasher in a detailed spreadsheet with HACCP data.



Our Connectivity system is a revolutionary device limiting and facilitating the eventual intervention of a technician who can anticipate the necessary parts to be replaced, saving time and money.

AS OPTION

AUTOMATIC SHOWER WITH FILTER DRAWER EASY+

Time and energy savings are increased thanks to AS and EASY+, a combined and specific filtering device. Dishes will only need a superficial manual clearing and the automatic shower of the AS module will do a pre-treatment action. (Not available with an installed K10 option).

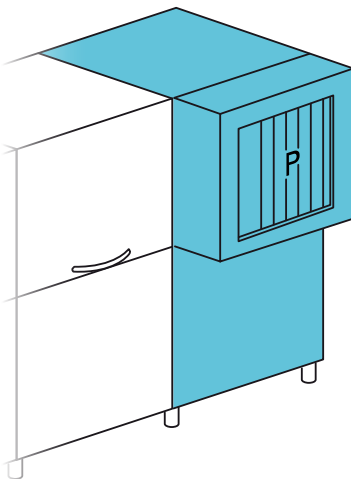
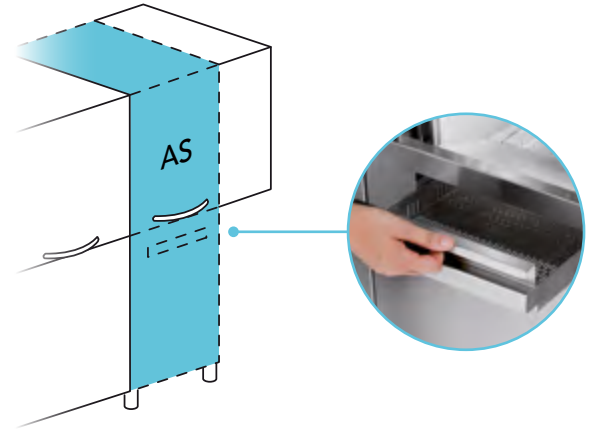

K10 OPTION

90° CORNER PRE-WASH

The design of our 90° corner pre-wash ensures the best solution taking up the minimal amount of space. Smaller dimensions, same productivity (Available on selected models and without AS option).









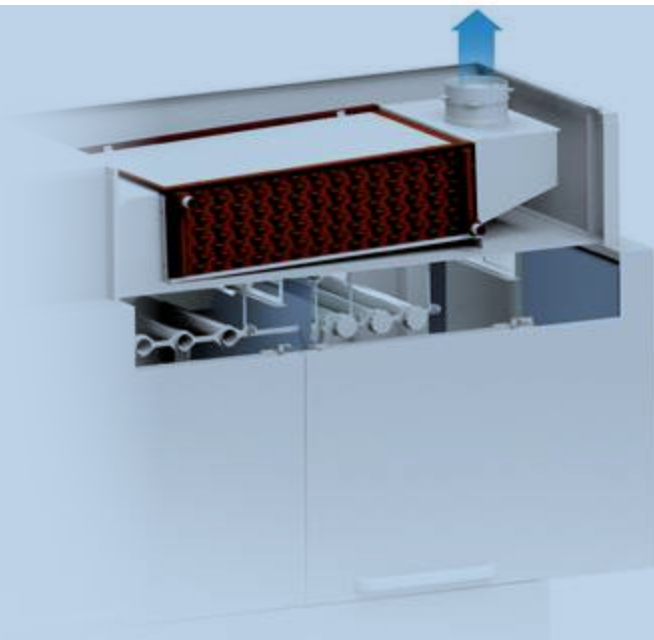

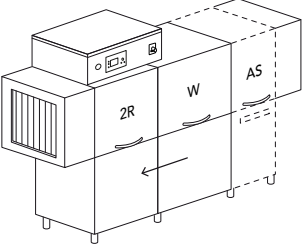



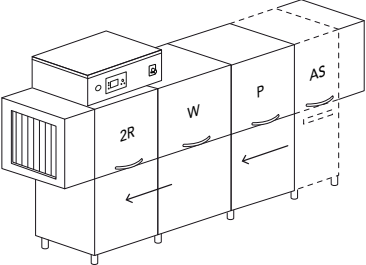

HEAT RECOVERY

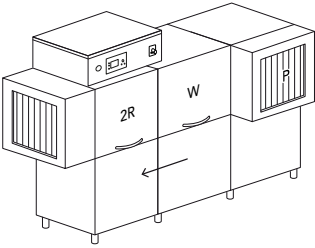



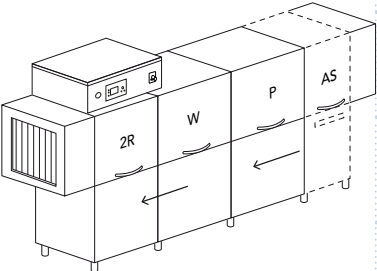





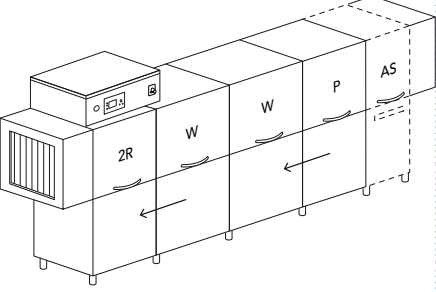

The heat recovery system allows to supply the machine with cold water*, ensuring at the same time significant savings in terms of energy consumptions. The steam produced by the machine in operation (otherwise dispersed in the working environment) is aspirated and condensed in the heat exchanger (air –water).

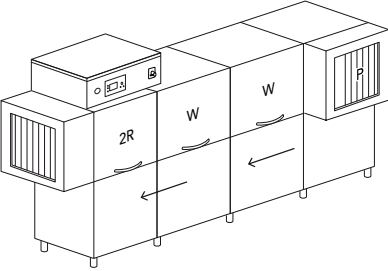
The heat produced through this process is transferred to the inlet water, bringing it to a temperature of approximately 45 °C and reducing energy consumptions.

*inlet water temperature between 8 °C and 15 °C

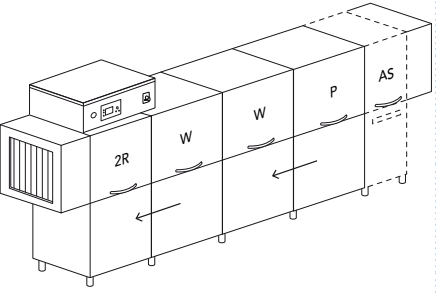

Model	Voltage	Capacity	Dimensions	Code		
RK 2460 5 SPEEDS						
	RACK EQUIPMENT 1 X C40 1 X C43 1 X C44 1 X C47		400 V 3N ~ 50 Hz 20,68 kW 400 V 3N ~ 50 Hz 2,68 kW 30 kg/h	 Ø 450  500x500 100* - 250 racks / h	2100x805 1830/2120 H 305 kg AS + 450 mm  GN 1/1 530x325x25H	RK 2460 RK 2460 AS RK 2460 V RK 2460 AS V
	RK 2960 5 SPEEDS					
	RACK EQUIPMENT 1 X C40 1 X C43 1 X C44 1 X C47		400 V 3N ~ 50 Hz 21,58 kW 400 V 3N ~ 50 Hz 3,58 kW 30 kg/h	 Ø 450  500x500 135* - 300 racks / h	2700x805 1830/2120 H 400 kg AS + 450 mm  GN 1/1 530x325x25H	RK 2960 RK 2960 AS RK 2960 V RK 2960 AS V
	RK 2960-K10 5 SPEEDS - CORNER PREWASH					
	RACK EQUIPMENT 1 X C40 1 X C43/B 1 X C44 1 X C47		400 V 3N ~ 50 Hz 21,58 kW 400 V 3N ~ 50 Hz 3,58 kW 30 kg/h	 Ø 450  500x500 135 - 300 racks / h	2425x985 1830/2120 H 400 kg AS + 450 mm  GN 1/1 530x325x25H	RK 2960-K10 RK 2960-K10 V
	RK 3260 5 SPEEDS					
	RACK EQUIPMENT 1 X C40 1 X C43 1 X C44 1 X C47		400 V 3N ~ 50 Hz 25,86 kW 400 V 3N ~ 50 Hz 4,86 kW 30 kg/h	 Ø 450  500x500 150* - 330 racks / h	3000x805 1830/2120 H 435 kg AS + 450 mm  GN 1/1 530x325x25H	RK 3260 RK 3260 AS RK 3260 V RK 3260 AS V

Model	Voltage	Capacity	Dimensions	Code
RK 3560 5 SPEEDS				
 <p>RACK EQUIPMENT</p> <ul style="list-style-type: none"> 1 X C40 1 X C43 1 X C44 1 X C47 	400 V 3N ~ 50 Hz 37,26 kW	 Ø 450	3600x805 1830/2120 H 520 kg	RK 3560
	400 V 3N ~ 50 Hz 5,76 kW 52 kg/h	 500x500 190* - 360 racks / h	 530x325x25H	RK 3560 AS
				RK 3560 V
				RK 3560 AS V
RK 3560-K10 5 SPEEDS - CORNER PREWASH				
 <p>RACK EQUIPMENT</p> <ul style="list-style-type: none"> 1 X C40 1 X C43/B 1 X C44 1 X C47 	400 V 3N ~ 50 Hz 37,26 kW	 Ø 450	3325x985 1830/2120 H 520 kg	RK 3560-K10
	400 V 3N ~ 50 Hz 5,76 kW 52 kg/h	 500x500 190* - 360 racks / h	 530x325x25H	RK 3560-K10 V
RK 3960 5 SPEEDS				
 <p>RACK EQUIPMENT</p> <ul style="list-style-type: none"> 1 X C40 1 X C43 1 X C44 1 X C47 	400 V 3N ~ 50 Hz 40,04 kW	 Ø 450	3900x805 1830/2120 H 560 kg	RK 3960
	400 V 3N ~ 50 Hz 7,04 kW 55 kg/h	 500x500 210* - 400 racks / h	 530x325x25H	RK 3960 AS
				RK 3960 V
				RK 3960 AS V

- V** Steam supply
- P** Prewash
- W** Wash
- 2R** Double reinforced rinse (pre-rinse + rinse on module)
- K10** Corner prewash
- AS** Automatic shower with filter drawer +450 mm
- *** Productivity according to DIN SPEC 10534 regulation (contact time)

EAC label upon request

Option compatibility to be confirmed by the manufacturer after verification

OPTIONS

Model	220-240 V 3 50 Hz			380-415 V 3N 50 Hz			PRE DOS	UNI DOS	DDE-GROUP	DOS/S	SAN	PAP-SAN	DWI / T	DWI
	60 Hz	KROMO disp. connections	UNIVERSAL disp. connec- tions	Dispensers kit	Dispenser with probe	Sanitization system	Booster pump sanitiz.	Tank insulation	Thermoacou- stic insulation					
RK 2460	€	●	+ 3%	●	€	€	€	€	€	€	€	€	€	€
RK 2460 AS	€	●	+ 3%	●	€	€	€	€	€	€	€	€	€	€
RK 2460 V	€	●	+ 3%	●	€	€	€	€	€	€	€	€	€	€
RK 2460 AS V	€	●	+ 3%	●	€	€	€	€	€	€	€	€	€	€
RK 2960	€	●	+ 3%	●	€	€	€	€	€	€	€	€	€	€
RK 2960 AS	€	●	+ 3%	●	€	€	€	€	●	€	€	€	€	€
RK 2960 V	€	●	+ 3%	●	€	€	€	€	€	€	€	€	€	€
RK 2960 AS V	€	●	+ 3%	●	€	€	€	€	●	€	€	€	€	€
RK 2960-K10	€	●	+ 3%	●	€	€	€	€	€	€	€	€	€	€
RK 2960-K10 V	€	●	+ 3%	●	€	€	€	€	€	€	€	€	€	€
RK 3260	€	●	+ 3%	●	€	€	€	€	€	€	€	€	€	€
RK 3260 AS	€	●	+ 3%	●	€	€	€	€	●	€	€	€	€	€
RK 3260 V	€	●	+ 3%	●	€	€	€	€	€	€	€	€	€	€
RK 3260 AS V	€	●	+ 3%	●	€	€	€	€	●	€	€	€	€	€
RK 3560	€	●	+ 3%	●	€	€	€	€	●	€	€	€	€	€
RK 3560 AS	€	●	+ 3%	●	€	€	€	€	●	€	€	€	€	€
RK 3560 V	€	●	+ 3%	●	€	€	€	€	●	€	€	€	€	€
RK 3560 AS V	€	●	+ 3%	●	€	€	€	€	●	€	€	€	€	€
RK 3560-K10	€	●	+ 3%	●	€	€	€	€	●	€	€	€	€	€
RK 3560-K10 V	€	●	+ 3%	●	€	€	€	€	●	€	€	€	€	€
RK 3960	€	●	+ 3%	●	€	€	€	€	●	€	€	€	€	€
RK 3960 AS	€	●	+ 3%	●	€	€	€	€	●	€	€	€	€	€
RK 3960 V	€	●	+ 3%	●	€	€	€	€	●	€	€	€	€	€
RK 3960 AS V	€	●	+ 3%	●	€	€	€	€	●	€	€	€	€	€

● Standard

--- Not available

DDE-GROUP Both detergent (with probe) and rinse-aid dispensers included

DOS/S For detergent dispenser only

SAN Including dosing system for sanitizing product

DWI Insulation option for the tunnel only, dryer excluded. Shelf dryer can be insulated upon request. Recommended with KHR10 – KHR20 – KHRP40

DWI - DWI/T Recommended with KHR10 – KHR20 – KHRP40

DIV Compulsory for machines > 4,5 m

XP In case of cold water supply for rinse 8 °C 55 °C, and without any heat recovery, the extra power option is mandatory

	PAP	BT	DVGW	XP	DIV	CONN.	PI	SA	1-DRAIN	AUTOTIMER	ECO-DET	DRIVE
Model	Booster pump	Break tank	DVGW	Extra power	Price for division	Connectivity (HACCP)	S/S pumps	Automatized drain	Centralized drain	Autotimer	Detergent economizer	Smart drive 5 speeds
RK 2460	€	€	€	€	€	€	€	€	●	●	●	●
RK 2460 AS	€	€	€	€	€	€	€	€	●	●	●	●
RK 2460 V	€	€	€	€	€	€	€	----	●	●	●	●
RK 2460 AS V	€	€	€	€	€	€	€	----	●	●	●	●
RK 2960	€	€	€	€	€	€	€	€	●	●	●	●
RK 2960 AS	€	€	€	€	€	€	€	€	●	●	●	●
RK 2960 V	€	€	€	€	€	€	€	----	●	●	●	●
RK 2960 AS V	€	€	€	€	€	€	€	----	●	●	●	●
RK 2960-K10	€	€	€	€	€	€	€	€	●	●	●	●
RK 2960-K10 V	€	€	€	€	€	€	€	----	●	●	●	●
RK 3260	€	€	€	€	€	€	€	€	●	●	●	●
RK 3260 AS	€	€	€	€	€	€	€	€	●	●	●	●
RK 3260 V	€	€	€	€	€	€	€	----	●	●	●	●
RK 3260 AS V	€	€	€	€	€	€	€	----	●	●	●	●
RK 3560	€	€	€	----	€	€	€	€	●	●	●	●
RK 3560 AS	€	€	€	----	€	€	€	€	●	●	●	●
RK 3560 V	€	€	€	----	€	€	€	----	●	●	●	●
RK 3560 AS V	€	€	€	----	€	€	€	----	●	●	●	●
RK 3560-K10	€	€	€	----	€	€	€	€	●	●	●	●
RK 3560-K10 V	€	€	€	----	€	€	€	----	●	●	●	●
RK 3960	€	€	€	----	€	€	€	€	●	●	●	●
RK 3960 AS	€	€	€	----	€	€	€	€	●	●	●	●
RK 3960 V	€	€	€	----	€	€	€	----	●	●	●	●
RK 3960 AS V	€	€	€	----	€	€	€	----	●	●	●	●

CONNECTIVITY Includes HACCP option. 10 year plan

PI Available with 50 Hz frequency only. Not available for AS module

DVGW Not available with heat recovery and steam condenser
Components prescribed by DVGW on request (check option compatibility with the manufacturer)

BT Booster pump included

With osmotic water supply and electrical conductivity lower than 200 microsiemens, it is mandatory to install a stainless steel heat exchanger

Water supply 55 °C. Water hardness min 2°f - max 8°f (if higher, an external water softener is required)

We recommend to install the machine in a well ventilated room, with a properly sized steam exhausting system

Standard hints for scheduled maintenance and counters (working hours - water - energy)

Peak-cut connect upon request

OPTIONS

	KSC10	KHR10	KHR20	KHRP40	KDR64	KDR69	KDR6V	KDR94	KDR99	KDR9V
Model	Steam condenser	Heat recovery	Heat recovery	Heat recovery	Dryer + 400 mm / 4,5 kW	Dryer + 400 mm / 9 kW	Steam dryer + 400 mm	Dryer + 700 mm / 4,5 kW	Dryer + 700 mm / 9 kW	Steam dryer + 700 mm
RK 2460 - RK 2460 AS	€	€	----	€	€	€	----	€	€	----
RK 2460 V - RK 2460 AS V	€	€	----	€	----	----	€	----	----	€
RK 2960 - RK 2960 AS	€	€	€	€	€	€	----	€	€	----
RK 2960 V - RK 2960 AS V	€	€	€	€	----	----	€	----	----	€
RK 2960-K10	€	€	€	€+	€	€	----	€	€	----
RK 2960-K10 V	€	€	€	€+	----	----	€	----	----	€
RK 3260 - RK 3260 AS	€	€	€	€	€	€	----	€	€	----
RK 3260 V - RK 3260 AS V	€	€	€	€	----	----	€	----	----	€
RK 3560 - RK 3560 AS	€	€	€	€	€	€	----	€	€	----
RK 3560 V - RK 3560 AS V	€	€	€	€	----	----	€	----	----	€
RK 3560-K10	€	€	€	€+	€	€	----	€	€	----
RK 3560-K10 V	€	€	€	€+	----	----	€	----	----	€
RK 3960 - RK 3960 AS	€	€	€	€	€	€	----	€	€	----
RK 3960 V - RK 3960 AS V	€	€	€	€	----	----	€	----	----	€

ID Recommended for KDR69 - KDR6V - KDR99 - KDR9V. Not available for corner dryers

+ In models with LC K10 it is not available when 90° and 180° curve drying is added

KHRP40 Available with 400 V 3N 50 Hz frequency only

KHR20 As an alternative KHR10 or KHRP40
For the model RK 2960-K10 +50 mm length with installed KHR20 and dryer

KDRA184MT - KDRA189MT Mandatory division

KHR10-KHR20-KHRP40 In case of cold water supply for rinse (8-15 °C), we recommend to install the heat recovery system optional.

KDR64 - KDR94 - KDRA94MT - KDRA184MT Not recommended for models RK 2960, RK 3260, RK 3560, RK 3960. Verify with manufacturer

Option compatibility to be confirmed by the manufacturer after verification

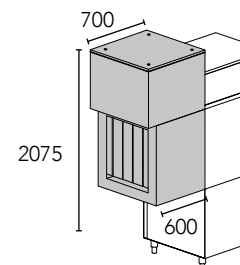
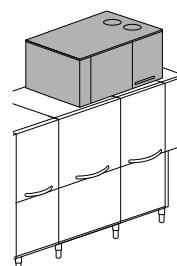
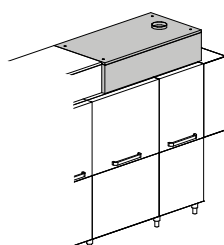
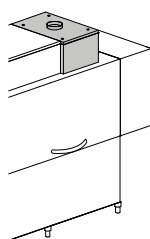
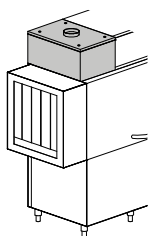

KSC10

Steam condenser

KHR10

Compact heat recovery

KHR20

Heat recovery

KHRP40

Heat recovery with heat pump

KDR64

4,5 kW Electric

KDR69

9 kW Electric

Dryer

KDR6V

Steam dryer

	KDRA94MT	KDRA99MT	KDRA9VMT	KDRA184MT	KDRA189MT	KDRA18VMT	ID
Model	Motorized dryer 90° arc 4,5 kw	Motorized dryer 90° arc 9 kw	Motorized steam dryer 90° arc	Motorized dryer 180° arc 4,5 kW	Motorized dryer 180° arc 9 kW	Motorized steam dryer 180° arc	Double skin for dryer
RK 2460 - RK 2460 AS	€	€	----	€	€	----	€
RK 2460 V - RK 2460 AS V	----	----	€	----	----	€	€
RK 2960 - RK 2960 AS	€	€	----	€	€	----	€
RK 2960 V - RK 2960 AS V	----	----	€	----	----	€	€
RK 2960-K10	€	€	----	€	€	----	€
RK 2960-K10 V	----	----	€	----	----	€	€
RK 3260 - RK 3260 AS	€	€	----	€	€	----	€
RK 3260 V - RK 3260 AS V	----	----	€	----	----	€	€
RK 3560 - RK 3560 AS	€	€	----	€	€	----	€
RK 3560 V - RK 3560 AS V	----	----	€	----	----	€	€
RK 3560-K10	€	€	----	€	€	----	€
RK 3560-K10 V	----	----	€	----	----	€	€
RK 3960 - RK 3960 AS	€	€	----	€	€	----	€
RK 3960 V - RK 3960 AS V	----	----	€	----	----	€	€

AVAILABLE ARCS:

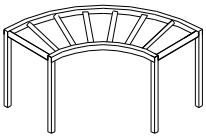

K21 1300x1300x860 H
90° roller arc with tank

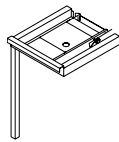

K25 700x610x820 H
Angle loading table complete with basket pull-through system

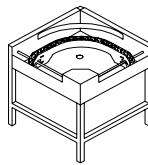

K22 850x850x885 H
90° motorized arc (clockwise/ counter-clockwise)

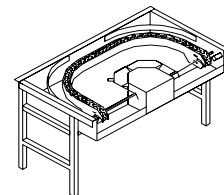

K23 850x1500x885 H
180° motorized arc (clockwise/ counter-clockwise)

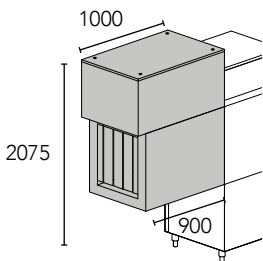

KDR94 4,5 kW Electric
KDR99 9 kW Electric
Dryer

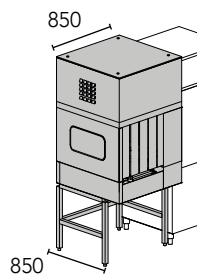

KDRA94MT 4,5 kW Electric
KDRA99MT 9 kW Electric
Dryer with motorized arc 90°

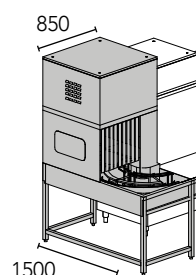

KDRA184MT 4,5 kW Electric
KDRA189MT 9 kW Electric
Dryer with motorized arc 180°

KDR9V
Steam dryer

KDRA9VMT
Steam dryer with motorized arc 90°

KDRA18VMT
Steam dryer with motorized arc 180°

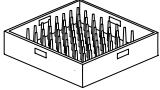
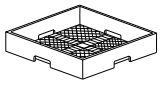
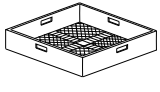
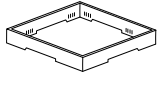
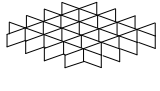
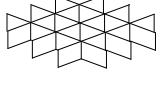
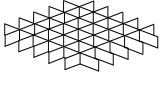
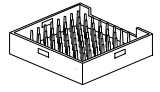
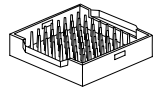
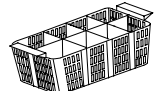
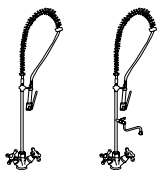
	Description	Capacity	Dimensions	Code	
	PLATE BASKET	18 plates	500x500x105 H	C 40	
	NARROW MESH CUTLERY BASKET		500x500x106 H	C 41	
	LARGE MESH BASKET	For glasses	500x500x105 H	C 44	
	HOLDER FOR GLASS SUPPORT	For glass support (C112-C113-C114)	500x500x50 H	C 111	
	GLASS SUPPORT	5x5 Glass Ø 87 mm (C111)	500x500x50 H	C 112	
	GLASS SUPPORT	4x4 Glass Ø 110 mm (C111)	500x500x50 H	C 113	
	GLASS SUPPORT	6x6 Glass Ø 72 mm (C111)	500x500x50 H	C 114	
	TRAYS BASKET	8 pcs, max. depth 25 mm	500x500x105 H	C 43	
	GASTRONORM TRAYS BASKET GN 1/1	6 pcs, max. depth 25 mm	500x500x105 H	C 43/B	
	CUTLERY BASKET		490x180x140 H	C 47	
	FLEXIBLE SHOWER complete with mixing group and lever tap, to be fixed to the wall		1000 H	K 1	
	FLEXIBLE SHOWER complete with mixing group and lever tap, to be fixed to the wall and intermediate tap		1000 H	K 1HR	

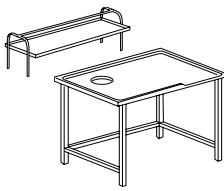
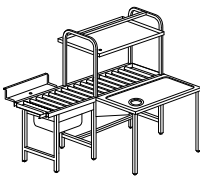
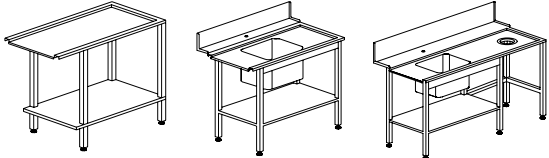
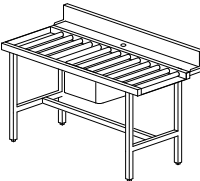
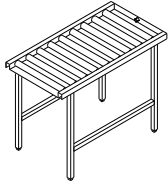
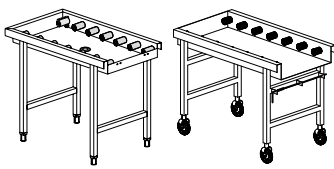
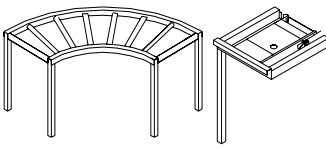
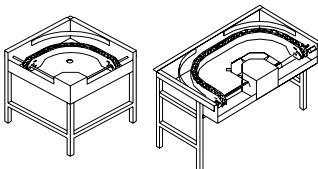
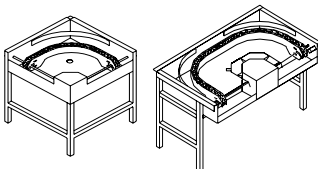
	Description	Capacity	Dimensions	Code
	SHELF		1515x620x660 H 2315x620x660 H	K 7M16 * ▣ K 7M24 * ▣
	GRADING TABLE WITH RUBBER RING AND HOLE	Special dimensions upon request	1600x1000x850 H 2400x1000x850 H	K 7A/1600 * ▣ K 7A/2400 * ▣
	MECHANIZED GRADING TABLE With mechanized basket advancement system	1 waste hole 2 waste holes	1800x1240x1525 H 2400x1240x1525 H	K M7/1800 * ▣ K M7/2400 * ▣
		K 4B K 55 K 8 - K 9		1200x590x860 H 1200x730x860 H 1500x730x860 H 1800x730x860 H
	ROLLER TABLE + sink, right or left version Sink 500x400x270 H		1600x730x860 H	K 195 ▣
	LINEAR ROLLER TABLE WITH TANK		1100x650x860 H 1600x650x860 H 2100x650x860 H	K 19 * ▣ K 19/B * ▣ K 19/C * ▣
	k 19/1 - k 19/1A k 20/1 - k 20/1A	LINEAR ROLLER TABLE WITH TANK complete with end microswitch	Option end microswitch	K 18
	90°roller arc with tank (exit only with roller table) Angle loading table complete with basket pull-through system	Not compatible with same references Not on 180° arcs	1100x650x860 H 1600x650x860 H 1150x650x860 H 1650x650x860 H	K 19/1 ▣ K 19/1A ▣ K 20/1 ▣ K 20/1A ▣
	90° MOTORIZED ARC (clockwise/counter-clockwise) 180° MOTORIZED ARC (clockwise/counter-clockwise)	To be connected to KM 23 only and to dryer on 180°	1300x1300x860 H 700x610x820 H	K 21 * K 25
	90° MOTORIZED ARC (clockwise/counter-clockwise) 180° MOTORIZED ARC (clockwise/counter-clockwise)	It is mandatory to order the motorized arc with the machine	850x850x885 H 850x1500x885 H	K 22 * K 23 *

* Wooden cage +2% minimum + € / ▣Special dimensions for tables upon request / Tables shown in right-to-left version
We strongly recommend the presence of a roller table with end microswitch at the exit of our rack type machines for a correct operation



Thanks to the rack conveyor dishwashers of RK PREMIUM series, new efficiency goals are met. The 3R + three-step rinse system ensures considerable savings in terms of water consumption and unmatched quality results. The reduction of heat losses granted by thermal insulation walls, the heat that is produced from the steam produced inside the machine (in case of HDR optional), supports the main innovation of the product range to reduce the

pollution. Its user-friendly design characterizes both the washing process and the daily cleaning and maintenance operations. The wide TFT screen makes the access to operating functions easy and comfortable. The IPX5 control panel, the rack-washing arms, the machine sanitization and the automatic drain options, make all the daily operations to be complete much more comfortable.



FEATURES

STANDARD

- TFT 5.7" display and soft touch keyboard
- IPX5 electronic board
- Easy-access frontal panel
- Constant monitoring of key operating parameters with integrated HACCP interface
- Detailed information and history of alarms in 6 languages
- Chemicals level management and related alerts/information
- SMART DRIVE+ advancement system with 10 speeds
- ECO-DET Detergent economizer
- Triple reinforced rinse 3R+ with adjustable water flow
- 1-DRAIN centralized drain
- Break Tank with integrated booster pump
- Thermal and acoustic insulation, insulated tanks
- Battery auto-cleaning for heat recovery system (if HDR option present)
- Control function for water, energy consumptions and working time
- Possible working modes for dryer unit: all off, only fan or total power + fan (4,5 kW or 9 kW, maximum power according to the model)
- Preset maintenance reminder
- AISI 316 stainless steel tanks and boilers

OPTIONS

- Automatic fill / drain tanks and boiler through SA servovalves
- Detergent dispenser with probe or dispensers kit
- Extra power for boiler
- KHDR200: insulated dryer + heat recovery system
- KHDRA209M and KHDRA218M, insulated, on 90°/180° motorized chain conveyor
- Machine sanitization with dedicated booster pump
- Stainless steel pumps
- CONNECTIVITY remote control compliant with the HACCP norms

CONNECTIVITY 4.0 & APP

WHEREVER YOU ARE...
YOUR DISHWASHER, JUST A CLICK AWAY

You will be constantly connected to the machine to monitor the work phases, review any eventual alarm and configure remotely the operating parameters according to your needs. Compliant with HACCP norms. Thanks to our brand new App, you will have access to connected machines and all commercial and technical documentation.

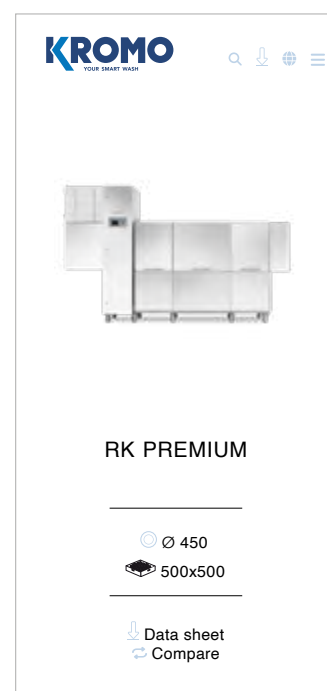
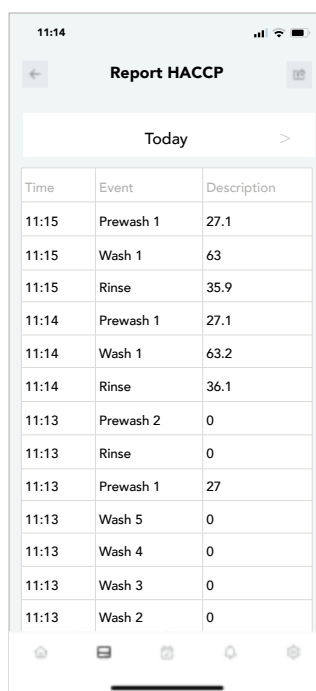
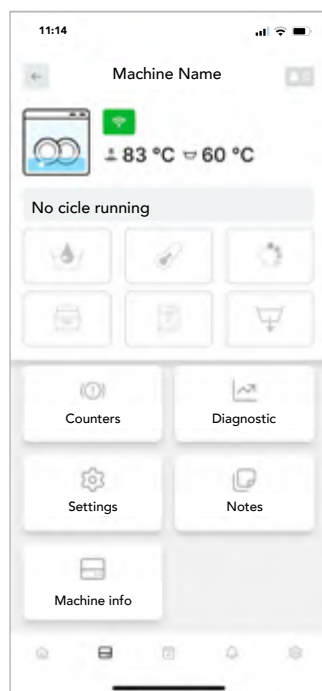

View all the working parameters and event records, working hours and any problem at any time.



In case of problem, the machine promptly alerts you. The technician can intervene remotely to solve the problem or anticipate the needed parts for an on-site intervention.



A daily activity report is available with all the events related to the dishwasher in a detailed spreadsheet with HACCP data.



Our Connectivity system is a revolutionary device limiting and facilitating the eventual intervention of a technician who can anticipate the necessary parts to be replaced, saving time and money.

AS OPTION

AUTOMATIC SHOWER WITH FILTER DRAWER EASY+

Time and energy savings are increased thanks to AS and EASY+, a combined and specific filtering device. Dishes will only need a superficial manual clearing and the automatic shower of the AS module will do a pre-treatment action. (Not available with an installed K10 option).

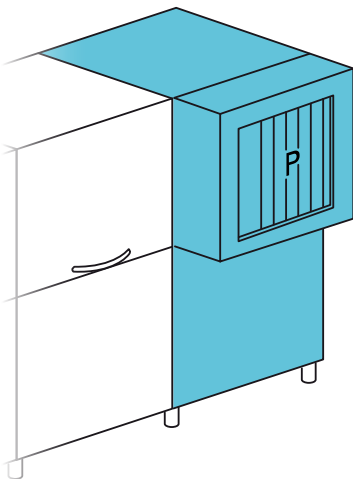
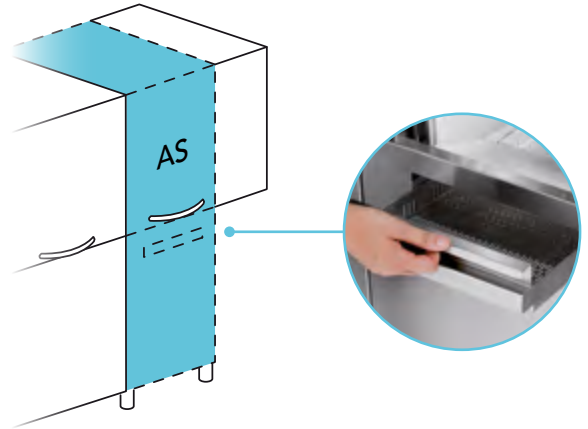

K10 OPTION

90° CORNER PRE-WASH

The design of our 90° corner pre-wash ensures the best solution taking up the minimal amount of space. Smaller dimensions, same productivity (Available on selected models and without AS option).

HEAT RECOVERY

The heat recovery system allows to supply the machine with cold water*, ensuring at the same time significant savings in terms of energy consumptions. The steam produced by the machine in operation (otherwise dispersed in the working environment) is aspirated and condensed in the heat exchanger (air –water).

The heat produced through this process is transferred to the inlet water, bringing it to a temperature of approximately 45 °C and reducing energy consumptions.

*inlet water temperature between 8 °C and 15 °C

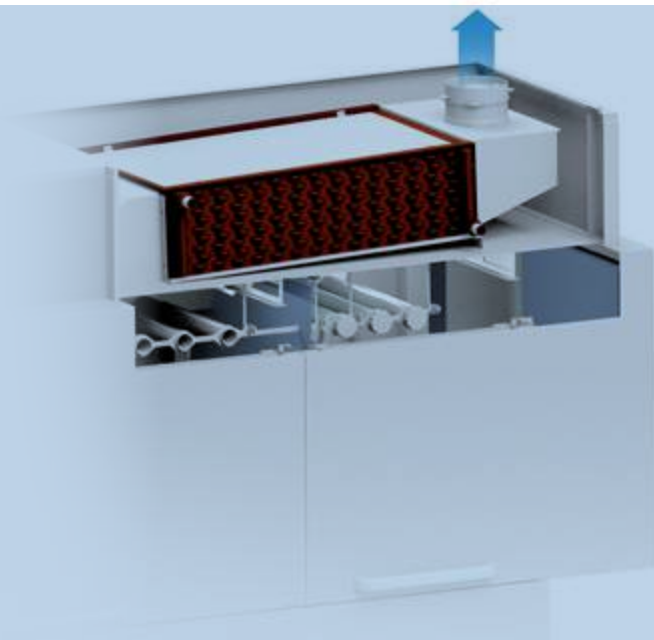

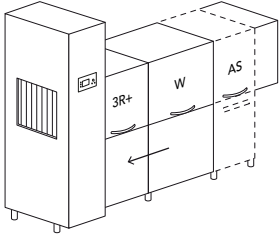
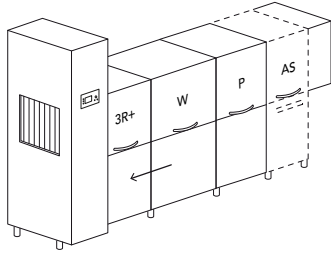
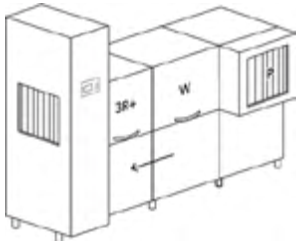
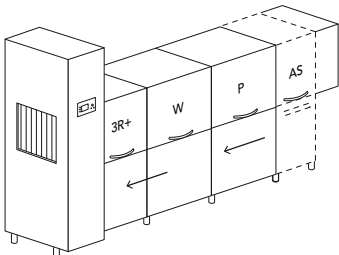
Model	Voltage	Capacity	Dimensions	Code	
RK 2500 10 SPEEDS					
	<p>RACK EQUIPMENT</p> <ul style="list-style-type: none"> 1 x C40 1 x C43 1 x C44 1 x C47 	<p>400 V 3N ~ 50 Hz 21,43 kW</p>	<p>Ø 450</p> <p>500x500</p> <p>100* - 250 racks / h</p>	<p>2250x920 2100/2120 H 350 kg</p> <p>AS + 450 mm</p> <p>GN 1/1</p> <p>530x325x25H</p>	<p>RK 2500</p> <p>RK 2500 AS</p>
RK 3000 10 SPEEDS					
	<p>RACK EQUIPMENT</p> <ul style="list-style-type: none"> 1 x C40 1 x C43 1 x C44 1 x C47 	<p>400 V 3N ~ 50 Hz 22,33 kW</p>	<p>Ø 450</p> <p>500x500</p> <p>135* - 300 racks / h</p>	<p>2850x920 2100/2120 H 510 kg</p> <p>AS + 450 mm</p> <p>GN 1/1</p> <p>530x325x25H</p>	<p>RK 3000</p> <p>RK 3000 AS</p>
RK 3000-K10 CORNER PREWASH - 10 SPEEDS					
	<p>RACK EQUIPMENT</p> <ul style="list-style-type: none"> 1 x C40 1 x C43/B 1 x C44 1 x C47 	<p>400 V 3N ~ 50 Hz 22,43 kW</p>	<p>Ø 450</p> <p>500x500</p> <p>135 - 300 racks / h</p>	<p>2575x985 2100/2120 H 510 kg</p> <p>GN 1/1</p> <p>530x325x25H</p>	<p>RK 3000-K10</p>
RK 3300 10 SPEEDS					
	<p>RACK EQUIPMENT</p> <ul style="list-style-type: none"> 1 x C40 1 x C43 1 x C44 1 x C47 	<p>400 V 3N ~ 50 Hz 26,61 kW</p>	<p>Ø 450</p> <p>500x500</p> <p>150* - 330 racks / h</p>	<p>3150x920 2100/2120 H 550 kg</p> <p>AS + 450 mm</p> <p>GN 1/1</p> <p>530x325x25H</p>	<p>RK 3300</p> <p>RK 3300 AS</p>

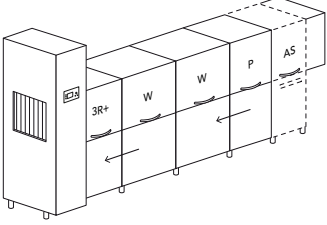
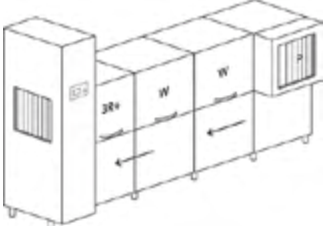
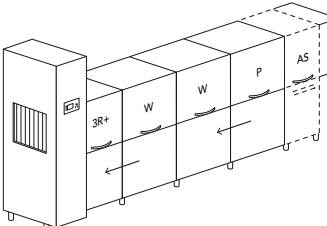
Model	Voltage	Capacity	Dimensions	Code	
RK 3600 10 SPEEDS					
	<p>RACK EQUIPMENT</p> <ul style="list-style-type: none"> 1 x C40 1 x C43 1 x C44 1 x C47 	<p>400 V 3N ~ 50 Hz 38,01 kW</p>	<p>Ø 450</p> <p>500x500</p> <p>190* - 360 racks / h</p>	<p>3750x920 2100/2120 H 710 kg</p> <p>AS + 450 mm</p> <p>GN 1/1</p> <p>530x325x25H</p>	<p>RK 3600</p> <p>RK 3600 AS</p>
RK 3600-K10 CORNER PREWASH -10 SPEEDS					
	<p>RACK EQUIPMENT</p> <ul style="list-style-type: none"> 1 x C40 1 x C43/B 1 x C44 1 x C47 	<p>400 V 3N ~ 50 Hz 38,01 kW</p>	<p>Ø 450</p> <p>500x500</p> <p>190* - 360 racks / h</p>	<p>3475x985 2100/2120 H 710 kg</p> <p>GN 1/1</p> <p>530x325x25H</p>	<p>RK 3600-K10</p>
RK 4000 10 SPEEDS					
	<p>RACK EQUIPMENT</p> <ul style="list-style-type: none"> 1 x C40 1 x C43 1 x C44 1 x C47 	<p>400 V 3N ~ 50 Hz 40,79 kW</p>	<p>Ø 450</p> <p>500x500</p> <p>210* - 400 racks / h</p>	<p>4050x920 2100/2120 H 750 kg</p> <p>AS + 450 mm</p> <p>GN 1/1</p> <p>530x325x25H</p>	<p>RK 4000</p> <p>RK 4000 AS</p>

- P** Prewash
- W** Wash
- 3R+** Triple reinforced rinse (double pre-rinse + rinse on module)
- K10** Corner prewash
- AS** Automatic shower with filter drawer + 450 mm
- *** Productivity according to DIN SPEC 10534 regulation (contact time)

EAC label upon request

Option compatibility to be confirmed by the manufacturer after verification

OPTIONS

Model	220-240 V 3 50 Hz	380-415 V 3N 50 Hz	60 Hz	PRE DOS KROMO disp. connections	DDE-GROUP Dispensers kit	DOS/S Dispenser with probe	SAN Sanitization system	PAP-SAN Booster pump sanitiz.	DWI Thermoacou- stic insulation	DWI / T Tank insulation	XP Extra power
RK 2500	€	●	+3%	●	€	€	€	€	●	●	€
RK 2500 AS	€	●	+3%	●	€	€	€	€	●	●	€
RK 3000	€	●	+3%	●	€	€	€	€	●	●	€
RK 3000 AS	€	●	+3%	●	€	€	€	●	●	●	€
RK 3000-K10	€	●	+3%	●	€	€	€	€	●	●	€
RK 3300	€	●	+3%	●	€	€	€	€	●	●	€
RK 3300 AS	€	●	+3%	●	€	€	€	●	●	●	€
RK 3600	€	●	+3%	●	€	€	€	●	●	●	€
RK 3600 AS	€	●	+3%	●	€	€	€	●	●	●	€
RK 3600-K10	€	●	+3%	●	€	€	€	●	●	●	€
RK 4000	€	●	+3%	●	€	€	€	●	●	●	€
RK 4000 AS	€	●	+3%	●	€	€	€	●	●	●	€

- Standard
- DDE-GROUP** Both detergent (with probe) and rinse-aid dispensers included
- DOS/S** For detergent dispenser only
- SAN** Including dosing system for sanitizing product
- PAP-SAN** Supplied AS standard with sanitization option on models:
RK 3000 AS, RK 3300 AS, RK 3600 AS, RK 3600-K10 , RK 4000, RK 4000 AS
- DIV** Compulsory for machines > 4,5 m
- XP** In case of cold water supply for rinse 8 °C 55 °C, and without any heat recovery, the extra power option is mandatory

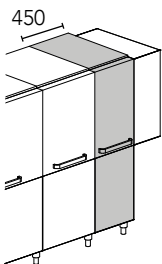

AS
Automatic Shower
with filter drawer

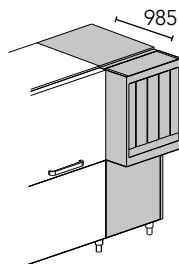

K10
Corner prewash

	DIV	CONN.	PI	SA	1-DRAIN	AUTOTIMER	PAP	BT	DVGW	ECO-DET	SMART DRIVE+
Model	Price for division	Connectivity (HACCP)	S/S pumps	Automatized drain	Centralized drain	Autotimer	Booster pump	Break tank	DVGW	Detergent economizer	Smart drive 10 speeds
RK 2500	€	€	€	€	●	●	●	●	€	●	●
RK 2500 AS	€	€	€	€	●	●	●	●	€	●	●
RK 3000	€	€	€	€	●	●	●	●	€	●	●
RK 3000 AS	€	€	€	€	●	●	●	●	€	●	●
RK 3000-K10	€	€	€	€	●	●	●	●	€	●	●
RK 3300	€	€	€	€	●	●	●	●	€	●	●
RK 3300 AS	€	€	€	€	●	●	●	●	€	●	●
RK 3600	€	€	€	€	●	●	●	●	€	●	●
RK 3600 AS	€	€	€	€	●	●	●	●	€	●	●
RK 3600-K10	€	€	€	€	●	●	●	●	€	●	●
RK 4000	€	€	€	€	●	●	●	●	€	●	●
RK 4000 AS	€	€	€	€	●	●	●	●	€	●	●

CONNECTIVITY Includes HACCP option. 10 year plan

PI Available with 50 Hz frequency only. Not available for AS module

DVGW Not available with heat recovery and steam condenser
Components prescribed by DVGW on request (check option compatibility with the manufacturer)

In case of cold water supply for rinse (8-15 °C), we recommend to install the heat recovery system optional.

With osmotic water supply and electrical conductivity lower than 200 microsiemens, it is mandatory to install a stainless steel heat exchanger

Water supply 55 °C. Water hardness min 2°f - max 8°f (if higher, an external water softener is required)

We recommend to install the machine in a well ventilated room, with a properly sized steam exhausting system

Standard hints for scheduled maintenance and counters (working hours - water - energy)

Option compatibility to be confirmed by the manufacturer after verification

AVAILABLE ARCS:

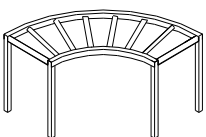

K 21 1300x1300x860 H
90° roller arc with tank

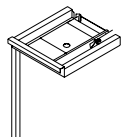

K 25 700x610x820 H
Angle loading table complete with basket pull-through system

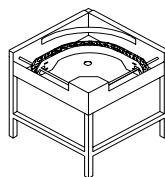

K 22 850x850x885 H
90° motorized arc (clockwise/ counter-clockwise)

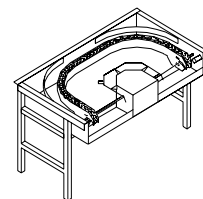

K 23 850x1500x885 H
180° motorized arc (clockwise/ counter-clockwise)

OPTIONS

	KLC30	KSC10	KSC15	KHR15	KHR20	KHRP40
Model	Splash guard + 300 mm	Steam condenser	Steam condenser	Heat recovery	Heat recovery	Heat recovery
RK 2500	€	€	€	€	€	€
RK 2500 AS	€	€	€	€	€	€
RK 3000	€	€	€	€	€	€
RK 3000 AS	€	€	€	€	€	€
RK 3000-K10	€	€	€	€	€	€+
RK 3300	€	€	€	€	€	€
RK 3300 AS	€	€	€	€	€	€
RK 3600	€	€	€	€	€	€
RK 3600 AS	€	€	€	€	€	€
RK 3600-K10	€	€	€	€	€	€+
RK 4000	€	€	€	€	€	€
RK 4000 AS	€	€	€	€	€	€

---- Not available

+ Not available for K10 version if the machine is next to the wall

KHDR200 Dryer + heat recovery. Fully insulated device. As an alternative KHDRA209M or KHDRA218M

KHDRA209M Dryer + heat recovery on 90° motorized arc. Fully insulated device.
As an alternative KHDR200 or KHDRA218M

KHDRA218M Dryer + heat recovery on 180° motorized arc. Fully insulated device.
As an alternative KHDR200 or KHDRA209M. Mandatory division

In case of cold water supply for rinse (8-15 °C), we recommend to install the heat recovery system optional.

With osmotic water supply and electrical conductivity lower than 200 microsiemens, it is mandatory to install a stainless steel heat exchanger

Water supply 55 °C

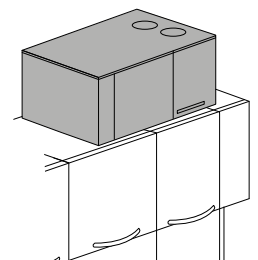
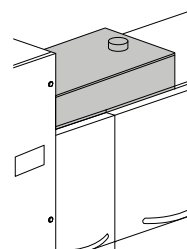
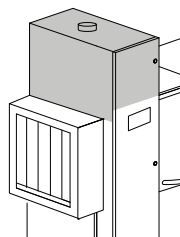
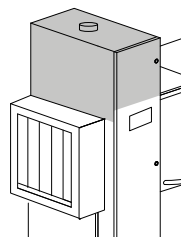
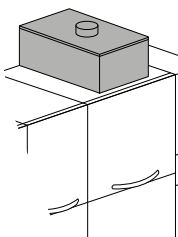

KSC10

Steam condenser

KSC15

Steam condenser

KHR15

Compact heat
recovery

KHR20

Heat recovery

KHRP40



Heat recovery
with heat pump

Model	KHDR200	KHDRA209M	KHDRA218M	KDR204	KDR209	KDRA99MT	KDRA189MT
	Dryer + heat recovery	Dryer + heat recovery	Dryer + heat recovery	Dryer	Insulated dryer	Motorized dryer 90° arc	Motorized dryer 180° arc
RK 2500	€	€	€	€	€	€	€
RK 2500 AS	€	€	€	€	€	€	€
RK 3000	€	€	€	€	€	€	€
RK 3000 AS	€	€	€	€	€	€	€
RK 3000-K10	€	€	€	€	€	€	€
RK 3300	€	€	€	€	€	€	€
RK 3300 AS	€	€	€	€	€	€	€
RK 3600	€	€	€	€	€	€	€
RK 3600 AS	€	€	€	€	€	€	€
RK 3600-K10	€	€	€	€	€	€	€
RK 4000	€	€	€	€	€	€	€
RK 4000 AS	€	€	€	€	€	€	€

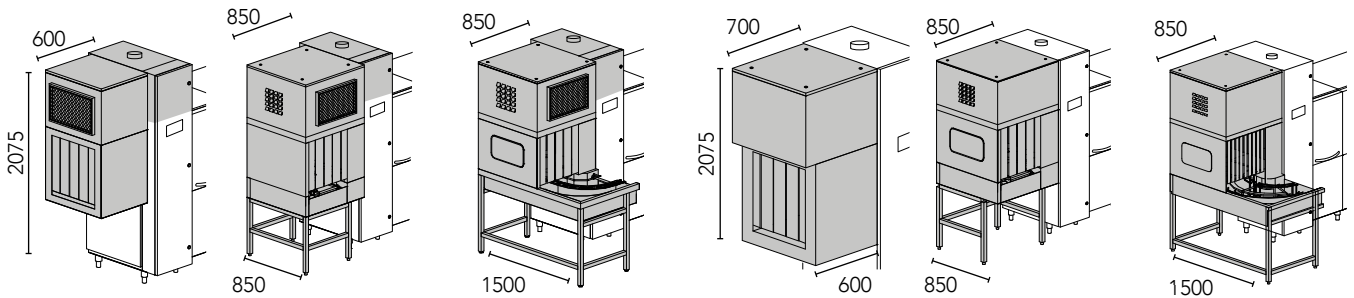
- KSC10** Available only with optional dryer
 - KSC15** Not available with optional dryer
 - KHR20** As an alternative KHR15 or KHRP40.
 - KHRP40** Available with 400 V 3N 50 Hz frequency only
 - KHR15-KHR20-KHRP40** In case of cold water supply for rinse (8-15 °C), we recommend to install the heat recovery system optional.
 - KDR204** Not recommended for models RK 3000, RK 3300, RK 3600, RK 4000. Verify with manufacturer
 - KDRA99MT - KDRA189MT** Mandatory division
- Option compatibility to be confirmed by the manufacturer after verification

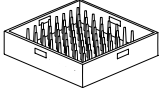
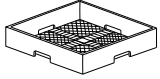
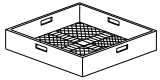
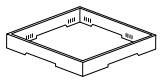
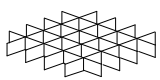
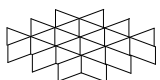
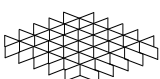
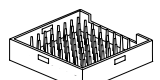
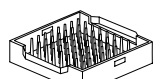

KHDR200 4,5kW Electric dryer + heat recovery	KHDRA209M 4,5kW Electric dryer on 90° motorized arc + heat recovery	KHDRA218M 4,5kW Electric Dryer on 180° motorized arc + Heat Recovery	KDR204 4,5kW KDR209 9 kW Insulated dryer	KDRA99MT 9 kW Dryer with motorized arc 90°	KDRA189MT 9 kW Dryer with motorized arc 180°
---	---	--	--	---	---

	Description	Capacity	Dimensions	Code
	PLATE BASKET	18 plates	500x500x105 H	C 40
	NARROW MESH CUTLERY BASKET		500x500x106 H	C 41
	LARGE MESH BASKET	For glasses	500x500x105 H	C 44
	HOLDER FOR GLASS SUPPORT	For glass support (C112-C113-C114)	500x500x50 H	C 111
	GLASS SUPPORT	5x5 Glass Ø 87 mm (C111)	500x500x50 H	C 112
	GLASS SUPPORT	4x4 Glass Ø 110 mm (C111)	500x500x50 H	C 113
	GLASS SUPPORT	6x6 Glass Ø 72 mm (C111)	500x500x50 H	C 114
	TRAYS BASKET	8 pcs, max. depth 25 mm	500x500x105 H	C 43
	GASTRONORM TRAYS BASKET GN 1/1	6 pcs, max. depth 25 mm	500x500x105 H	C 43/B
	CUTLERY BASKET		490x180x140 H	C 47
	FLEXIBLE SHOWER complete with mixing group and lever tap, to be fixed to the wall		1000 H	K 1
	FLEXIBLE SHOWER complete with mixing group and lever tap, to be fixed to the wall and intermediate tap		1000 H	K 1HR

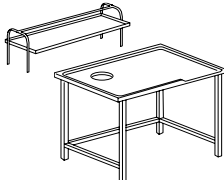
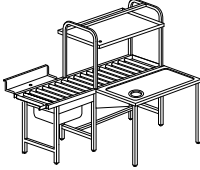
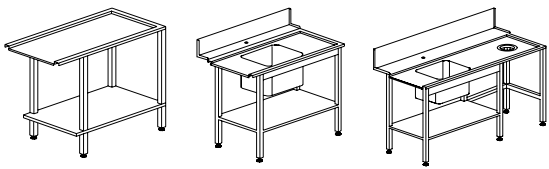
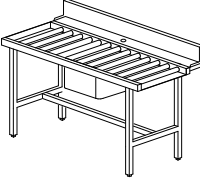
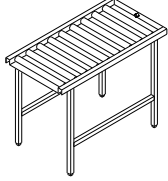
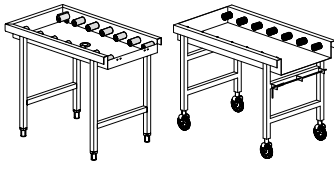
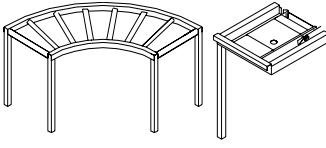
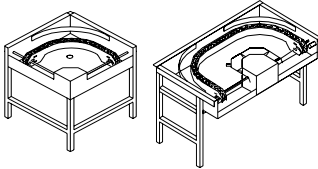
	Description	Capacity	Dimensions	Code
	SHELF		1515x620x660 H 2315x620x660 H	K 7M16 * ▣ K 7M24 * ▣
	GRADING TABLE WITH RUBBER RING AND HOLE	Special dimensions upon request	1600x1000x850 H 2400x1000x850 H	K 7A/1600 * ▣ K 7A/2400 * ▣
	MECHANIZED GRADING TABLE With mechanized basket advancement system	1 waste hole 2 waste holes	1800x1240x1525 H 2400x1240x1525 H	K M7/1800 * ▣ K M7/2400 * ▣
		<p>K 4B K 55 K 8 - K 9</p> <p>Sink 500x400x270 H Sink 500x400x270 H</p>	Standard rubber ring Standard rubber ring	1200x590x860 H 1200x730x860 H 1500x730x860 H 1800x730x860 H
	ROLLER TABLE + sink, right or left version Sink 500x400x270 H		1600x730x860 H	K 195 ▣
	LINER ROLLER TABLE WITH TANK	Option end microswitch	1100x650x860 H 1600x650x860 H 2100x650x860 H	K 19 * ▣ K 19/B * ▣ K 19/C * ▣ K 18
	<p>K 19/1 - K 19/1A K 20/1 - K 20/1A</p> <p>LINER ROLLER TABLE WITH TANK complete with end microswitch</p>	Not compatible with same references Not on 180° arcs To be connected to KM 23 only and to dryer on 180°	1100x650x860 H 1600x650x860 H 1150x650x860 H 1650x650x860 H	K 19/1 ▣ K 19/1A ▣ K 20/1 ▣ K 20/1A ▣
	<p>90° roller arc with tank (exit only with roller table)</p> <p>Angle loading table complete with basket pull-through system</p>	Optional connection to prewash tables	1300x1300x860 H 700x610x820 H	K 21 * ▣ K 25
	<p>90° MOTORIZED ARC (clockwise/counter-clockwise)</p> <p>180° MOTORIZED ARC (clockwise/counter-clockwise)</p>		850x850x885 H 850x1500x885 H	K 22 * ▣ K 23 * ▣

* Wooden cage +2% minimum + € / ▣ Special dimensions for tables upon request / Tables shown in right-to-left version
We strongly recommend the presence of a roller table with end microswitch at the exit of our rack type machines for a correct operation



You deserve the best. With the new QK PREMIUM "Green", you will have it! This range has been enhanced and rewarded with the SMART LABEL HOST 2023 award for its functional efficiency. Thanks to innovative pre-rinse and rinse arms, we have achieved exceptional results while maintaining the same performance: 35% water savings compared to previous versions! Added to this innovation is the introduction of new options, including a renewed triple rinse with osmotic water and an improved drying system, which make them flexible, complete and first-class flight-type conveyor dishwashers. Let us not forget that KROMO's vision is to minimize the use of environmental resources but also your

operating costs. Features such as the detergent economizer, the concept of thermal insulation, the CPF system and the double reinforced rinse show KROMO's wish to progress in the search for innovative solutions, ever more profitable and environmental friendly. Unique systems like HDRF make the machine energy self-sufficient and cost effective. Finally, the communication experience with the machine has been revolutionized thanks to the brand new Connectivity remote interaction system, available on all electronic devices and on the brand new KROMO App. Everything is under control in the blink of an eye!



FEATURES

STANDARD

- SMART DRIVE+ 10 speed advancement system
- 710 mm wide conveyor
- Plates belt
- TFT 5.7" display and soft touch keyboard
- Frequently used keys shortcut and menu language setting
- Constant monitoring of key operations
- IPX5 electronic board
- Alarms and events report
- Autotimer
- Break Tank system
- Centralized 1-DRAIN and automatic AD drain, with total or partial emptying of the tanks
- Wash arms ALL-IN-1
- Economizer for area usage
- ECO-DET Detergent economizer
- Thermal and acoustic insulation of both the machine and tanks
- ACID PROOF Radial wash tanks in S/S AISI 316 inclined to provide complete drainage of the wash water
- S/S surface filters CLEAN+ to protect the wash tanks as well as the wash pump
- Double-skin, insulated and counterbalanced doors, equipped with anti-drop safety system
- THERMO BARRIER system for comfort in use
- Predisposition for KROMO rinse-aid and detergent dispensers connection
- ACID PROOF stainless steel boilers in AISI 316, fully insulated to reduce thermal loss.
- Vertical self-cleaning pumps
- Booster pump
- 🌿 Reinforced triple rinse 3R+ : improved consumptions (reverse osmosis on request)
- CPF System: Controlled Pressure Flow
- Water, energy consumptions and working time control system



FEATURES

OPTIONS

- Five different conveyor belts available, also with cutlery lane
- Different types of dryers: double skin dryer on module (with or without turboblowers) or on shelf
- Possible working modes for dryer unit: all off, only fan, half power 4,5 kW + fan, total power 9 kW + fan
- Double skin lateral dryer on shelf: innovative system with upper fan for improved drying results
- Two types of steam condensers available
- Three models of heat recovery to be chosen
- HDRF: patented insulated linear system of dryer and heat recovery
Steam-heated system available. Self-cleaning of the heat exchanger included"
- Fourth reinforced rinse 4R+ con reverse osmotic water on a separate module
- AS6 Automatic shower with EASY+ with filter system
- Dispensers kit with peristaltic pump, for detergent as well as rinse-aid
- CONNECTIVITY remote control compliant with the HACCP norms (on request)
- Delivery in two or more parts, to ease installation operations
- Automatic self-cleaning of the machine available, with dedicated booster pump on request
- STOCK: Dedicated space for detergent and rinse-aid jugs
- S/S pumps
- Extra power in the boiler

STANDARD BELTS

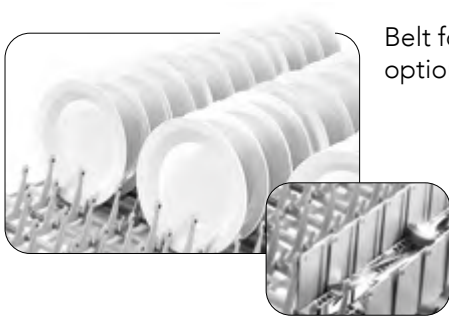

Belt for plates and optional cutlery lane



Belt for glasses



Belt for trays and utensils

OPTIONAL BELTS



Belt for hospitals



Belt for thermal trays



Belt for in-flight catering

CONNECTIVITY 4.0 & APP

WHEREVER YOU ARE...
YOUR DISHWASHER, JUST A CLICK AWAY

You will be constantly connected to the machine to monitor the work phases, review any eventual alarm and configure remotely the operating parameters according to your needs. Compliant with HACCP norms. Thanks to our brand new App, you will have access to connected machines and all commercial and technical documentation.

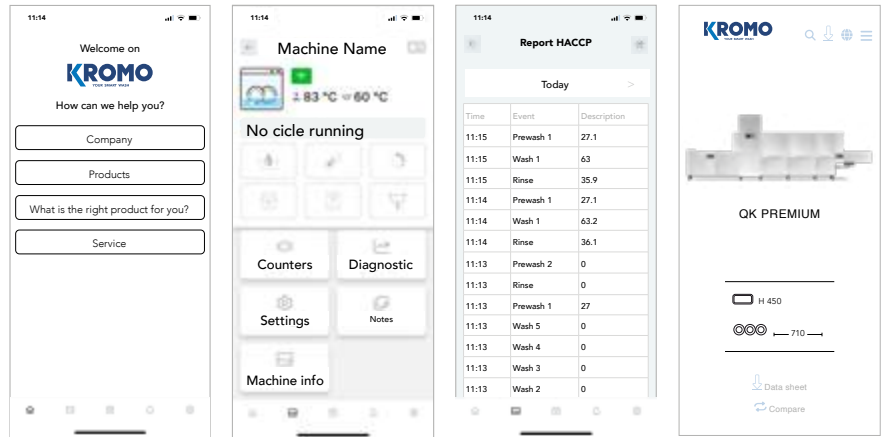

SMART LABEL HOST 2023 FOR FUNCTIONAL EFFICIENCY

According to the KROMO's sustainability vision and attention to customer operating costs, the QK range of flight conveyor dishwashers has been renewed. The result is a big amount of reduction the water consumption: more than 35% when compared to the previous version, an important figure in today's environmental and economic needs. To do so, new rinse and pre-rinse arms and ramps have been designed to achieve one of the lowest consumption levels in our sector. With lower water, KROMO continues to ensure high quality rinsing results. Indeed, a higher washing pressure guarantees optimal results with the removal of all the chemicals present on the dishes. Because of reduction the water consumption is caused the significant savings of such high expensive essential parts for washing like the energy and detergent.



View all the working parameters and event records, working hours and any problem at any time.











In case of problem, the machine promptly alerts you. The technician can intervene remotely to solve the problem or anticipate the needed parts for an on-site intervention.

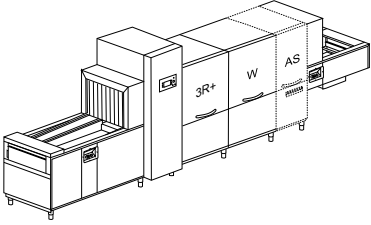

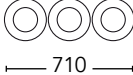
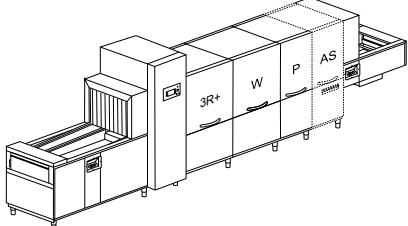

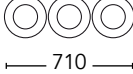
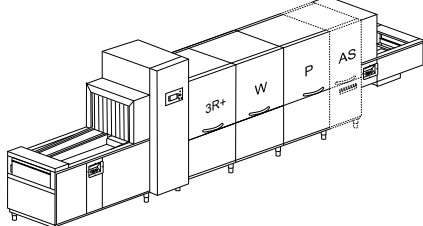

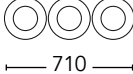
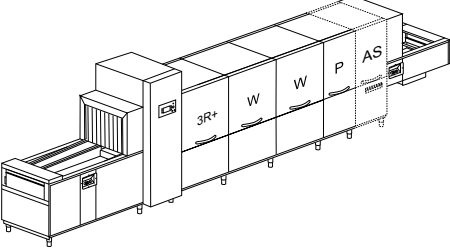

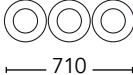
A daily activity report is available with all the events related to the dishwasher in a detailed spreadsheet with HACCP data.

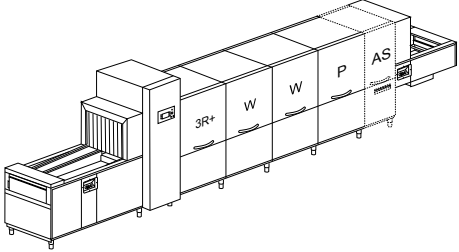

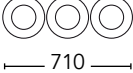
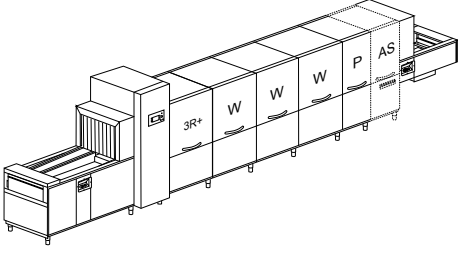
Our Connectivity system is a revolutionary device limiting and facilitating the eventual intervention of a technician who can anticipate the necessary parts to be replaced, saving time and money.

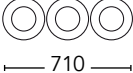
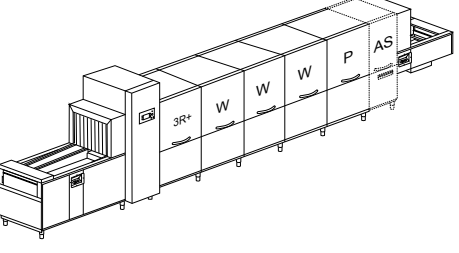
Model	Voltage	Capacity	Dimensions	Code
QK 2500 10 SPEEDS				
<i>IMPROVED</i>				
	400 V 3N ~ 50 Hz 24,6 kW	 450 H	5500x1110 2070/2200H 715 kg	QK 2500
		 710		QK 2500 AS6
	400 V 3N ~ 50 Hz 3,1 kW 35 kg/h	1950 / 3690 dishes / h	AS6 +600 mm	QK 2500 V
		2850* dishes / h		QK 2500 V AS6
QK 3800 10 SPEEDS				
<i>IMPROVED</i>				
	400 V 3N ~ 50 Hz 25,55 kW	 450 H	6100x1110 2070/2200H 850 kg	QK 3800
		 710		QK 3800 AS6
	400 V 3N ~ 50 Hz 4,05 kW 35 kg/h	2400 / 4050 dishes / h	AS6 +600 mm	QK 3800 V
		3660* dishes / h		QK 3800 V AS6
QK 4200 10 SPEEDS				
<i>IMPROVED</i>				
	400 V 3N ~ 50 Hz 26,6 kW	 450 H	6400x1110 2070/2200H 865 kg	QK 4200
		 710		QK 4200 AS6
	400 V3N ~ 50 Hz 5,1 kW 35 kg/h	3000 / 4800 dishes / h	AS6 +600 mm	QK 4200 V
		4200* dishes / h		QK 4200 V AS6
QK 5400 10 SPEEDS				
<i>IMPROVED</i>				
	400 V3N ~ 50 Hz 41,05 kW	 450 H	7000x1110 2070/2200H 1000 kg	QK 5400
		 710		QK 5400 AS6
	400 V 3N ~ 50 Hz 6,05 kW 58 kg/h	4200 / 6450 dishes / h	AS6 +600 mm	QK 5400 V
		5100* dishes / h		QK 5400 V AS6

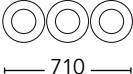
Model	Voltage	Capacity	Dimensions	Code
QK 6000 10 SPEEDS				
<i>IMPROVED</i>				
	400 V 3N ~ 50 Hz 43,6 kW	 450 H	7300x1110x2070/2200H 1015 kg AS6 +600 mm	QK 6000
	400 V 3N ~ 50 Hz 7,1 kW 60 kg/h	 710		4350 / 6750 dishes / h
		5550* dishes / h		QK 6000 V AS6
QK 6800 10 SPEEDS				
<i>IMPROVED</i>				
	400 V 3N ~ 50 Hz 58,05 kW	 450 H	8300x1110x2070/2200H 1150 kg AS6 +600 mm	QK 6800
	400 V 3N ~ 50 Hz 8,05 82 kg/h	 710		5250 / 8100 dishes / h
		5550* dishes / h		QK 6800 V AS6
QK 7800 10 SPEEDS				
<i>IMPROVED</i>				
	400 V 3N ~ 50 Hz 59,1 kW	 450 H	8600x1110x2070/2200H 1165 kg AS6 +600 mm	QK 7800
	400 V 3N ~ 50 Hz 9,1 kW 82 kg/h	 710		5850 / 9000 dishes / h
		6900* dishes / h		QK 7800 V AS6

- P** Prewash
- W** Wash
- 3R+** Reinforced triple rinse with low water consumption: double pre-rinse + rinse on module
- AS6** Automatic shower with filter drawer +600 mm
- V** Steam-heated
- *** Productivity according to DIN SPEC 10534 regulation (contact time)

EAC label upon request

Option compatibility to be confirmed by the manufacturer after verification

OPTIONS

Model	220-240 V 3 50 Hz	380-415 V 3N 50 Hz	60 Hz	AUTOTIMER Autotimer	PRE DOS KROMO disp. connections	DDE-GROUP Dispensers kit	DOS/S Dispenser with probe	SAN Sanitization system
QK 2500	+ 2%	●	+ 3%	●	●	€	€	€
QK 2500 AS6	+ 2%	●	+ 3%	●	●	€	€	€
QK 2500 V	+ 1%	●	+ 3%	●	●	€	€	€
QK 2500 V AS6	+ 1%	●	+ 3%	●	●	€	€	€
QK 3800	+ 2%	●	+ 3%	●	●	€	€	€
QK 3800 AS6	+ 2%	●	+ 3%	●	●	€	€	€
QK 3800 V	+ 1%	●	+ 3%	●	●	€	€	€
QK 3800 V AS6	+ 1%	●	+ 3%	●	●	€	€	€
QK 4200	+ 2%	●	+ 3%	●	●	€	€	€
QK 4200 AS6	+ 2%	●	+ 3%	●	●	€	€	€
QK 4200 V	+ 1%	●	+ 3%	●	●	€	€	€
QK 4200 V AS6	+ 1%	●	+ 3%	●	●	€	€	€
QK 5400	+ 2%	●	+ 3%	●	●	€	€	€
QK 5400 AS6	+ 2%	●	+ 3%	●	●	€	€	€
QK 5400 V	+ 1%	●	+ 3%	●	●	€	€	€
QK 5400 V AS6	+ 1%	●	+ 3%	●	●	€	€	€
QK 6000	+ 2%	●	+ 3%	●	●	€	€	€
QK 6000 AS6	+ 2%	●	+ 3%	●	●	€	€	€
QK 6000 V	+ 1%	●	+ 3%	●	●	€	€	€
QK 6000 V AS6	+ 1%	●	+ 3%	●	●	€	€	€
QK 6800	+ 2%	●	+ 3%	●	●	€	€	€
QK 6800 AS6	+ 2%	●	+ 3%	●	●	€	€	€
QK 6800 V	+ 1%	●	+ 3%	●	●	€	€	€
QK 6800 V AS6	+ 1%	●	+ 3%	●	●	€	€	€
QK 7800	+ 2%	●	+ 3%	●	●	€	€	€
QK 7800 AS6	+ 2%	●	+ 3%	●	●	€	€	€
QK 7800 V	+ 1%	●	+ 3%	●	●	€	€	€
QK 7800 V AS6	+ 1%	●	+ 3%	●	●	€	€	€

● Standard

□ Upon request

DDE-GROUP Both detergent (with probe) and rinse-aid dispensers included

DWI Insulation option for the tunnel only, dryer excluded. Shelf dryer can be double skin upon request

Peak-cut connect upon request

Water supply 55 °C. Water hardness min 2°f - max 8°f (if higher, an external water softener is required)

We recommend to install the machine in a well ventilated room, with a properly sized steam exhausting system

	PAP-SAN	DWI	DWI / T	CONNECTIVITY	XP	PAP	SMART DRIVE+
Model	Booster pump sanitiz.	Thermoacoustic insulation	Tank insulation	Connectivity (HACCP)	Extra power	Booster pump	Smart drive 10 speeds
QK 2500	€	●	●	€	€	●	●
QK 2500 AS6	€	●	●	€	€	●	●
QK 2500 V	€	●	●	€	□	●	●
QK 2500 V AS6	€	●	●	€	□	●	●
QK 3800	€	●	●	€	€	●	●
QK 3800 AS6	●	●	●	€	€	●	●
QK 3800 V	€	●	●	€	□	●	●
QK 3800 V AS6	●	●	●	€	□	●	●
QK 4200	€	●	●	€	€	●	●
QK 4200 AS6	●	●	●	€	€	●	●
QK 4200 V	€	●	●	€	□	●	●
QK 4200 V AS6	●	●	●	€	□	●	●
QK 5400	●	●	●	€	€	●	●
QK 5400 AS6	●	●	●	€	€	●	●
QK 5400 V	●	●	●	€	€	●	●
QK 5400 V AS6	●	●	●	€	€	●	●
QK 6000	●	●	●	€	€	●	●
QK 6000 AS6	●	●	●	€	€	●	●
QK 6000 V	●	●	●	€	€	●	●
QK 6000 V AS6	●	●	●	€	€	●	●
QK 6800	●	●	●	€	€	●	●
QK 6800 AS6	●	●	●	€	€	●	●
QK 6800 V	●	●	●	€	€	●	●
QK 6800 V AS6	●	●	●	€	€	●	●
QK 7800	●	●	●	€	€	●	●
QK 7800 AS6	●	●	●	€	€	●	●
QK 7800 V	●	●	●	€	□	●	●
QK 7800 V AS6	●	●	●	€	□	●	●

CONNECTIVITY Includes HACCP option. 10 year plan

XP In case of cold water supply for rinse 8 °C 55 °C, and without any heat recovery, the extra power option is mandatory
In case of cold water supply for rinse (8-15 °C), we recommend to install the heat recovery system.

Option compatibility to be confirmed by the manufacturer after verification

OPTIONS

Model	Master switch	Surface filters	Peak-cut for KROMO dosing	Estimated consumption readout	PI	1-DRAIN
					S/S pumps	Centralized drain
QK 2500	●	●	●	●	€	●
QK 2500 AS6	●	●	●	●	€	●
QK 2500 V	●	●	●	●	€	●
QK 2500 V AS6	●	●	●	●	€	●
QK 3800	●	●	●	●	€	●
QK 3800 AS6	●	●	●	●	€	●
QK 3800 V	●	●	●	●	€	●
QK 3800 V AS6	●	●	●	●	€	●
QK 4200	●	●	●	●	€	●
QK 4200 AS6	●	●	●	●	€	●
QK 4200 V	●	●	●	●	€	●
QK 4200 V AS6	●	●	●	●	€	●
QK 5400	●	●	●	●	€	●
QK 5400 AS6	●	●	●	●	€	●
QK 5400 V	●	●	●	●	€	●
QK 5400 V AS6	●	●	●	●	€	●
QK 6000	●	●	●	●	€	●
QK 6000 AS6	●	●	●	●	€	●
QK 6000 V	●	●	●	●	€	●
QK 6000 V AS6	●	●	●	●	€	●
QK 6800	●	●	●	●	€	●
QK 6800 AS6	●	●	●	●	€	●
QK 6800 V	●	●	●	●	€	●
QK 6800 V AS6	●	●	●	●	€	●
QK 7800	●	●	●	●	€	●
QK 7800 AS6	●	●	●	●	€	●
QK 7800 V	●	●	●	●	€	●
QK 7800 V AS6	●	●	●	●	€	●

● Standard

---- Not available

LANE Only with KDRF69 - KDRF6V

DIV Compulsory for machines > 4,5 m

BT Booster pump included

DVGW Not available with heat recovery and steam condenser
Components prescribed by DVGW on request (check option compatibility with the manufacturer)

	AD	ECO-DET	X-BELT	LANE	DIV	BT	DVGW
Model	Automatic drain	Detergent economizer	Special belt	Cutlery lane	Price for division	Break tank	DVGW
QK 2500	●	●	+ 7 %	----	€	●	€
QK 2500 AS6	●	●	+ 7 %	----	€	●	€
QK 2500 V	●	●	+ 7 %	----	€	●	€
QK 2500 V AS6	●	●	+ 7 %	----	€	●	€
QK 3800	●	●	+ 7 %	----	€	●	€
QK 3800 AS6	●	●	+ 7 %	----	€	●	€
QK 3800 V	●	●	+ 7 %	----	€	●	€
QK 3800 V AS6	●	●	+ 7 %	----	€	●	€
QK 4200	●	●	+ 7 %	+ 5 %	€	●	€
QK 4200 AS6	●	●	+ 7 %	----	€	●	€
QK 4200 V	●	●	+ 7 %	+ 5 %	€	●	€
QK 4200 V AS6	●	●	+ 7 %	----	€	●	€
QK 5400	●	●	+ 7 %	----	€	●	€
QK 5400 AS6	●	●	+ 7 %	----	€	●	€
QK 5400 V	●	●	+ 7 %	----	€	●	€
QK 5400 V AS6	●	●	+ 7 %	----	€	●	€
QK 6000	●	●	+ 7 %	+ 5 %	€	●	€
QK 6000 AS6	●	●	+ 7 %	----	€	●	€
QK 6000 V	●	●	+ 7 %	+ 5 %	€	●	€
QK 6000 V AS6	●	●	+ 7 %	----	€	●	€
QK 6800	●	●	+ 7 %	----	€	●	€
QK 6800 AS6	●	●	+ 7 %	----	€	●	€
QK 6800 V	●	●	+ 7 %	----	€	●	€
QK 6800 V AS6	●	●	+ 7 %	----	€	●	€
QK 7800	●	●	+ 7 %	+ 5 %	€	●	€
QK 7800 AS6	●	●	+ 7 %	----	€	●	€
QK 7800 V	●	●	+ 7 %	+ 5 %	€	●	€
QK 7800 V AS6	●	●	+ 7 %	----	€	●	€

Option compatibility to be confirmed by the manufacturer after verification

OPTIONS

Model	NZ3 Neutral zone 300	NZ6 Neutral zone 600	NZH6 Neutral zone for dryer 600	KDRF68 Shelf dryer	KDRF69 Shelf dryer	KDRF6V Steam- heated shelf dryer	KDRF70 Shelf dryer	KDRF7V Steam- heated shelf dryer	KDRF99M Stage Dryer	KDRF9VM Steam heated stage dryer	KDRF99MB Stage dryer with blowers	KDRF9VMB Steam heated stage dryer with blowers
QK 2500 - QK 2500 AS6	€	€	€	€	€	----	€	----	€	----	€	----
QK 2500 V - QK 2500 V AS6	€	€	€	€	€	€	€	€	€	€	€	€
QK 3800 - QK 3800 AS6	€	€	€	€	€	----	€	----	€	----	€	----
QK 3800 V - QK 3800 V AS6	€	€	€	€	€	€	€	€	€	€	€	€
QK 4200 - QK 4200 AS6	€	€	€	€	€	----	€	----	€	----	€	----
QK 4200 V - QK 4200 V AS6	€	€	€	€	€	€	€	€	€	€	€	€
QK 5400 - QK 5400 AS6	€	€	€	€	€	----	€	----	€	----	€	----
QK 5400 V - QK 5400 V AS6	€	€	€	€	€	€	€	€	€	€	€	€
QK 6000 - QK 6000 AS6	€	€	€	€	€	----	€	----	€	----	€	----
QK 6000 V - QK 6000 V AS6	€	€	€	€	€	€	€	€	€	€	€	€
QK 6800 - QK 6800 AS6	€	€	€	€	€	----	€	----	€	----	€	----
QK 6800 V - QK 6800 V AS6	€	€	€	€	€	€	€	€	€	€	€	€
QK 7800 - QK 7800 AS6	€	€	€	€	€	----	€	----	€	----	€	----
QK 7800 V - QK 7800 V AS6	€	€	€	€	€	€	€	€	€	€	€	€

---- Not available

NZ3 Recommended with big quantities of trays to wash

NZ6 Recommended for big quantities of trays to wash. Module equipped with a front door

NZH6 Recommended with dryers with blowers

All dryers have a double skin

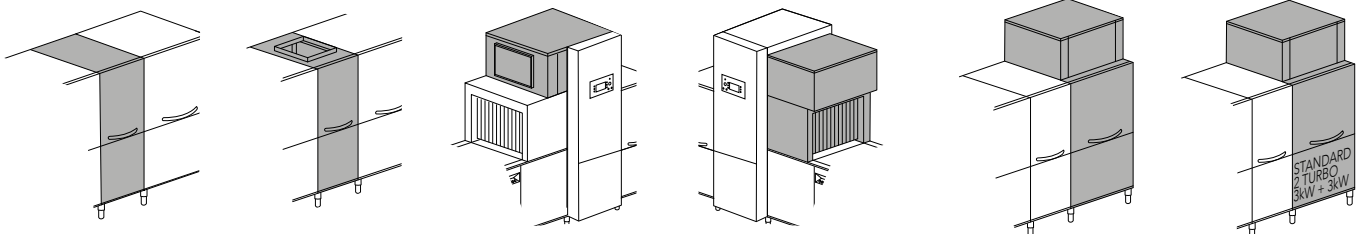

NZ3 + 300 mm
Neutral zone

NZH6 + 600 mm
Neutral zone with door for
dryer

KDRF68 9 kW
Shelf drying compact

KDRF69 9 kW
Shelf dryer

KDRF99M
+ 900 mm - 9 kW

Dryer module

KDRF99MB + 900 mm - 15 kW

Dryer module

NZ6 + 600 mm
Neutral zone with door

KDRF6V
Steam-heated shelf dryer

KDRF70
Double skin lateral shelf dryer with
upper fan

KDRF7V
Steam-heated double skin shelf
lateral dryer with upper fan

KDRF9VM + 900 mm
Steam-heated dryer
module

KDRF9VMB + 900 mm
Steam-heated dryer module

Model	KSCF10 Steam condenser	KSCF15 Steam condenser	KHRF15 Heat recovery	KHRF20 Heat recovery	KHRPF40 Heat recovery	3R+ Triple reinforced rinse	4R+ RO Quadruple reinforced rinse with RO	STOCK Chemicals compartment	KHDRF Heat recovery with dryer	KHDRFV Heat recovery with dryer
QK 2500 - QK 2500 AS6	€	€	€	€	€	●	€	€	€	----
QK 2500 V - QK 2500 V AS6	€	€	€	€	€	●	€	€	----	€
QK 3800 - QK 3800 AS6	€	€	€	€	€	●	€	€	€	----
QK 3800 V - QK 3800 V AS6	€	€	€	€	€	●	€	€	----	€
QK 4200 - QK 4200 AS6	€	€	€	€	€	●	€	€	€	----
QK 4200 V - QK 4200 V AS6	€	€	€	€	€	●	€	€	----	€
QK 5400 - QK 5400 AS6	€	€	€	€	€	●	€	€	€	----
QK 5400 V - QK 5400 V AS6	€	€	€	€	€	●	€	€	----	€
QK 6000 - QK 6000 AS6	€	€	€	€	€	●	€	€	€	----
QK 6000 V - QK 6000 V AS6	€	€	€	€	€	●	€	€	----	€
QK 6800 - QK 6800 AS6	€	€	€	€	€	●	€	€	€	----
QK 6800 V - QK 6800 V AS6	€	€	€	€	€	●	€	€	----	€
QK 7800 - QK 7800 AS6	€	€	€	€	€	●	€	€	€	----
QK 7800 V - QK 7800 V AS6	€	€	€	€	€	●	€	€	----	€

KDRF99M - KDRF9VM - KDRF99MB

Module with front door

KSCF15

Not available with optional dryer

3R+

Reinforced triple rinse: Improved consumptions (with reverse osmosis water on request). With separate module: 4R + RO. With osmotic water supply and electrical conductivity lower than 200 microsiemens, it is mandatory to install a stainless steel heat exchanger

KHRF15 - KHRF20 - KHRPF40 - KHDRF - KHDRFV

In case of cold water supply for rinse (8-15 °C), we recommend to install the heat recovery system as optional.

Water supply 55 °C. Water hardness min 2°f - max 8°f (if higher, an external water softener is required)

Option compatibility to be confirmed by the manufacturer after verification

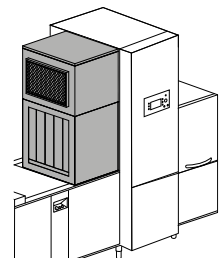
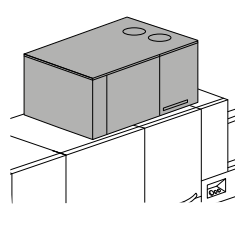
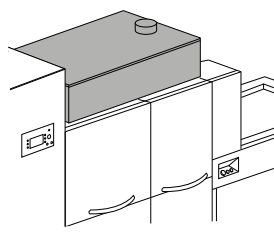
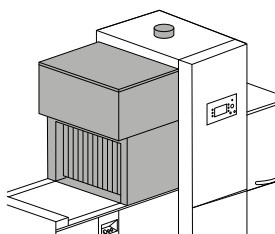
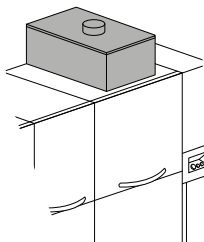

KSCF10

Steam condenser

KHRF15

Reinforced compact heat recovery

KHRF20

Heat recovery

KHRPF40

Heat recovery with heat pump

KHDRF

Electric dryer 9 kW + heat recovery

KSCF15

Reinforced steam condenser

KHDRFV

Steam heated dryer + heat recovery

OPTIONS

	MI900	MI1200	MIS1200	MI1500	MI1800	MI2200	MIR2200
Model	Entry mod. 900	Entry mod. 1200	Over. entry mod. 1200	Entry mod. 1500	Entry mod. 1800	Entry mod. 2200	Lowered belt entry mod. 2200
QK 2500 - QK 2500 AS6	€	€	●	€	€	€	€
QK 2500 V - QK 2500 V AS6	€	€	●	€	€	€	€
QK 3800 - QK 3800 AS6	€	€	●	€	€	€	€
QK 3800 V - QK 3800 V AS6	€	€	●	€	€	€	€
QK 4200 - QK 4200 AS6	€	€	●	€	€	€	€
QK 4200 V - QK 4200 V AS6	€	€	●	€	€	€	€
QK 5400 - QK 5400 AS6	€	€	●	€	€	€	€
QK 5400 V - QK 5400 V AS6	€	€	●	€	€	€	€
QK 6000 - QK 6000 AS6	€	€	●	€	€	€	€
QK 6000 V - QK 6000 V AS6	€	€	●	€	€	€	€
QK 6800 - QK 6800 AS6	€	€	●	€	€	€	€
QK 6800 V - QK 6800 V AS6	€	€	●	€	€	€	€
QK 7800 - QK 7800 AS6	€	€	●	€	€	€	€
QK 7800 V - QK 7800 V AS6	€	€	●	€	€	€	€

- Standard
- Upon request
- Not available

Option compatibility to be confirmed by the manufacturer after verification

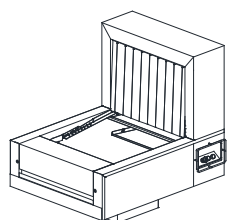

Overhanging entry module

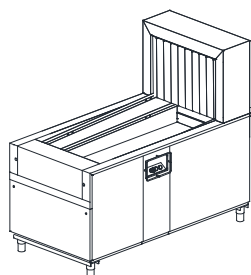

Entry module

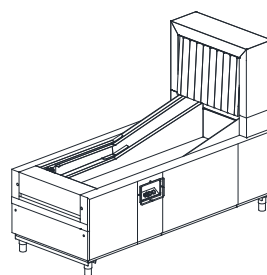

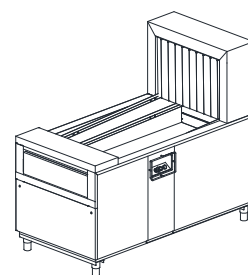

Lowered belt entry module

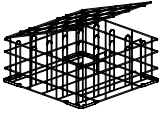

Exit module

	MI2700	MIR2700	EM900	EM1200	EM1500	EM1800	EM2200	EM2700
Model	Entry mod. 2700	Lowered belt entry mod. 2700	Exit mod. 900	Exit mod. 1200	Exit mod. 1500	Exit mod. 1800	Exit mod. 2200	Exit mod. 2700
QK 2500 - QK 2500 AS6	€	€	□	□	□	●	€	€
QK 2500 V - QK 2500 V AS6	€	€	□	□	□	●	€	€
QK 3800 - QK 3800 AS6	€	€	□	□	□	●	€	€
QK 3800 V - QK 3800 V AS6	€	€	□	□	□	●	€	€
QK 4200 - QK 4200 AS6	€	€	□	□	□	●	€	€
QK 4200 V - QK 4200 V AS6	€	€	□	□	□	●	€	€
QK 5400 - QK 5400 AS6	€	€	□	□	□	●	€	€
QK 5400 V - QK 5400 V AS6	€	€	□	□	□	●	€	€
QK 6000 - QK 6000 AS6	€	€	□	□	□	●	€	€
QK 6000 V - QK 6000 V AS6	€	€	□	□	□	●	€	€
QK 6800 - QK 6800 AS6	€	€	□	□	□	□	●	€
QK 6800 V - QK 6800 V AS6	€	€	□	□	□	□	●	€
QK 7800 - QK 7800 AS6	€	€	□	□	□	□	●	€
QK 7800 V - QK 7800 V AS6	€	€	□	□	□	□	●	€

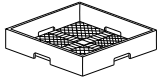
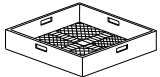
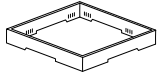
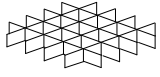
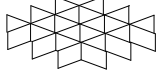
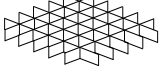
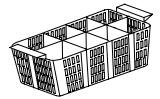
	Description	Capacity	Dimensions	Code	
	REUSABLE CUP BASKET *Only with flat belt	5x5 Glass 30 < Ø < 90 mm H max 185 mm	500x500x235 H	C 135 	
	NARROW MESH CUTLERY BASKET		500x500x106 H	C 41	
	LARGE MESH BASKET	For glasses	500x500x105 H	C 44	
	HOLDER FOR GLASS SUPPORT	For glass support (C112-C113-C114)	500x500x50 H	C 111	
	GLASS SUPPORT	5x5 Glass Ø 87 mm (C111)	500x500x50 H	C 112	
	GLASS SUPPORT	4x4 Glass Ø 110 mm (C111)	500x500x50 H	C 113	
	GLASS SUPPORT	6x6 Glass Ø 72 mm (C111)	500x500x50 H	C 114	
	CUTLERY BASKET		490x180x140 H	C 47	



Big news at KROMO! We are happy to introduce the "Green" QK LUX! This range has been enhanced and rewarded with the SMART LABEL HOST 2023 award for its functional efficiency. Thanks to innovative pre-rinse and rinse arms, we have achieved exceptional results while maintaining the same performance: 35% water savings compared to previous versions! Enhanced new options like renewed triple rinse, with osmotic water supply (on request) and improved drying system, we are proud to introduce flexible, complete and first-class flight-type conveyor dishwashers. Our goal is to minimize the use of environmental resources and operating costs. The features such as the detergent economizer thermal insulation, the CPF

system and the double reinforced rinse demonstrates KROMO's willingness to progress through innovative solutions and become more environmental friendly. As always, the KROMO flight-type conveyor dishwashers are available in multiple versions that can be combined with our other ranges (tray washers, rack conveyor dishwashers, transportation systems, etc). Our washing solutions, increasingly efficient over the years, adjust to different requirements while guaranteeing high hygiene standards to ensure optimal sanitation.



FEATURES

STANDARD

- SMART DRIVE 5 speeds advancement system
- 710 mm wide conveyor
- Plates belt
- TFT 5.7" display and soft touch keyboard
- Frequently used keys shortcut and menu language setting
- Constant monitoring of key operations
- IPX5 electronic board
- Alarms and events report
- Autotimer
- Centralized 1-DRAIN and automatic AD drain, with total or partial emptying of the tanks
- Wash arms ALL-IN-1
- Use economizer
- ECO-DET detergent economizer
- ACID PROOF radial wash tanks in S/S AISI 316 inclined to provide complete drainage of the wash water
- S/S surface filters CLEAN+ to protect the wash tanks as well as the wash pump
- Double-skin, insulated and counterbalanced doors, equipped with anti-drop safety system
- THERMO BARRIER system for comfort in use
- Predisposition for KROMO rinse-aid and detergent dispensers connection
- Non return valve
- ACID PROOF stainless steel boilers in AISI 316, fully insulated to reduce thermal loss.
- Vertical self-cleaning pumps
- 🌿 Reinforced double rinse 2R+, improved efficiency with lower consumption
- CPF System: Controlled Pressure Flow
- Water, energy consumptions and working time control system



OPTIONS

- Five different conveyor belts available, also with cutlery lane
- Different types of dryers: double skin dryer on module (with or without turboblowers) or on shelf (double skin on request)
- Possible working modes for dryer unit: all off, only fan, half power 4,5 kW + fan, total power 9 kW + fan
- Double skin lateral dryer on shelf: innovative system with upper fan for improved drying results
- Steam condenser
- Three models of heat recovery to be chosen
- Triple reinforced rinse 3R+ for drastically reduced water consumption (with reverse osmosis water on separate module on request)
- AS6 Automatic shower with EASY+ with filter system
- Dispensers kit with peristaltic pump, for detergent as well as rinse-aid
- CONNECTIVITY remote control compliant with the HACCP norms (on request)
- Delivery in two or more parts, to ease installation operations
- Automatic self-cleaning of the machine available, with dedicated booster pump on request
- Tank insulation
- Break tank and booster pump
- Dedicated space for detergent and rinse-aid jugs
- S/S pumps
- Extra power in the boiler

STANDARD BELTS

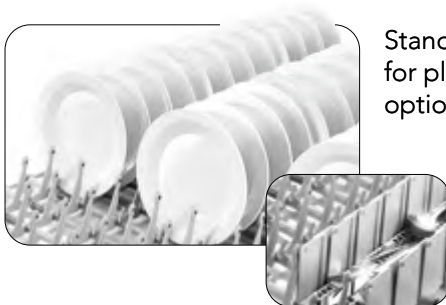

Standard belt for plates and optional cutlery lane



Standard belt for glasses



Standard belt for trays and utensils

OPTIONAL BELTS



Special belt for hospitals



Special belt for thermal trays



Special belt for in-flight catering

CONNECTIVITY 4.0 & APP

WHEREVER YOU ARE...
YOUR DISHWASHER, JUST A CLICK AWAY

You will be constantly connected to the machine to monitor the work phases, review any eventual alarm and configure remotely the operating parameters according to your needs. Compliant with HACCP norms. Thanks to our brand new App, you will have access to connected machines and all commercial and technical documentation.

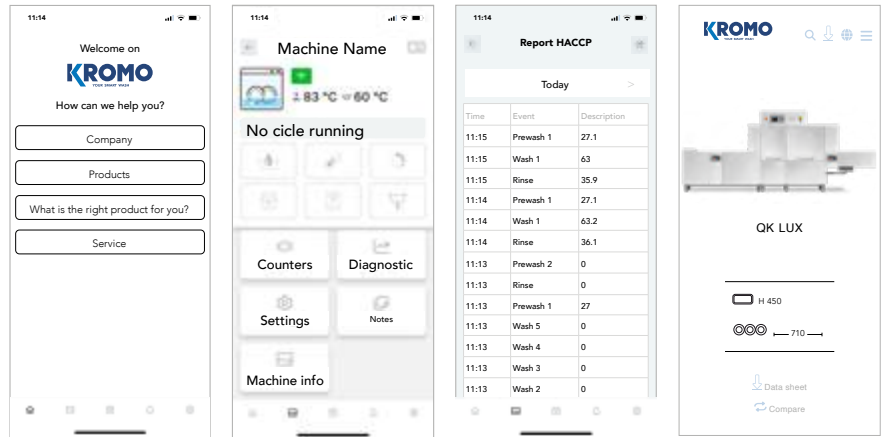

SMART LABEL HOST 2023 FOR FUNCTIONAL EFFICIENCY

According to the KROMO's sustainability vision and attention to customer operating costs, the QK range of flight conveyor dishwashers has been renewed. The result is a big amount of reduction the water consumption: more than 35% when compared to the previous version, an important figure in today's environmental and economic needs. To do so, new rinse and pre-rinse arms and ramps have been designed to achieve one of the lowest consumption levels in our sector. With lower water, KROMO continues to ensure high quality rinsing results. Indeed, a higher washing pressure guarantees optimal results with the removal of all the chemicals present on the dishes. Because of reduction the water consumption is caused the significant savings of such high expensive essential parts for washing like the energy and detergent.



View all the working parameters and event records, working hours and any problem at any time.











In case of problem, the machine promptly alerts you. The technician can intervene remotely to solve the problem or anticipate the needed parts for an on-site intervention.

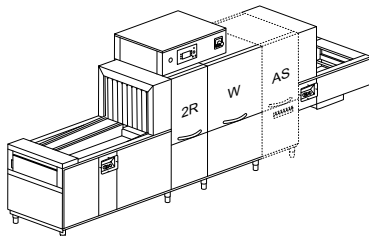

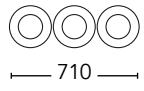
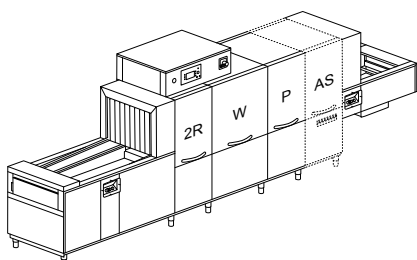

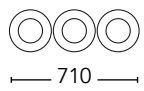
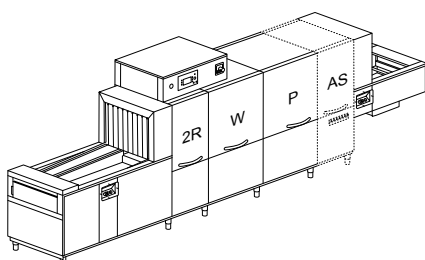

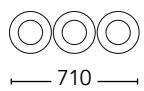
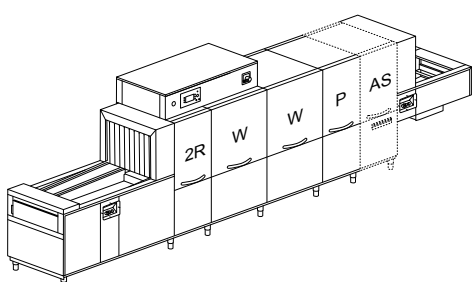

A daily activity report is available with all the events related to the dishwasher in a detailed spreadsheet with HACCP data.

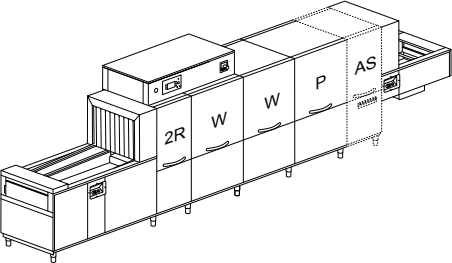

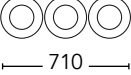
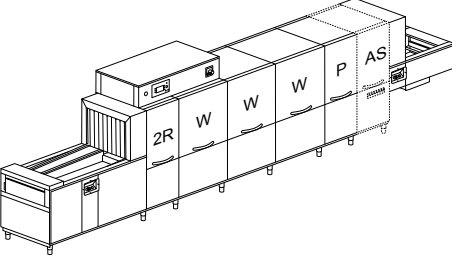
Our Connectivity system is a revolutionary device limiting and facilitating the eventual intervention of a technician who can anticipate the necessary parts to be replaced, saving time and money.

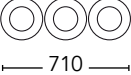
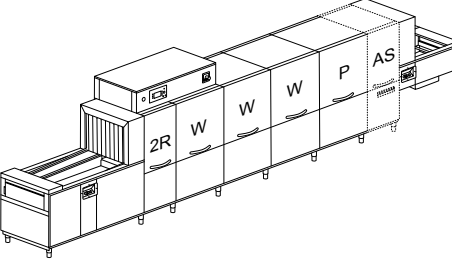
Model	Voltage	Capacity	Dimensions	Code
QK 2460 5 SPEEDS				
<i>IMPROVED</i>				
	400 V 3N ~ 50 Hz 24 kW	 450 H	4500x985 1860/2200H 595 kg	QK 2460
	400 V 3N ~ 50 Hz 2,5 kW 35 kg/h	 710 1950 / 3690 dishes / h 2400* dishes / h		AS6 +600 mm
QK 3760 5 SPEEDS				
<i>IMPROVED</i>				
	400 V 3N ~ 50 Hz 26,45 kW	 450 H	5100x985 1860/2200H 730 kg	QK 3760
	400 V 3N ~ 50 Hz 3,45 kW 38 kg/h	 710 2400 / 4050 dishes / h 3300* dishes / h		AS6 +600 mm
QK 4160 5 SPEEDS				
<i>IMPROVED</i>				
	400 V 3N ~ 50 Hz 27,5 kW	 450 H	5400x985 1860/2200H 745 kg	QK 4160
	400 V 3N ~ 50 Hz 4,5 kW 38 kg/h	 710 3000 / 4800 dishes / h 3750* dishes / h		AS6 +600 mm
QK 5360 5 SPEEDS				
<i>IMPROVED</i>				
	400 V 3N ~ 50 Hz 41,95 kW	 450 H	6000x985x 1860/2200H 880 kg	QK 5360
	400 V 3N ~ 50 Hz 5,45 kW 60 kg/h	 710 4200 / 6450 dishes / h 4650* dishes / h		AS6 +600 mm

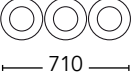
Model	Voltage	Capacity	Dimensions	Code
QK 5960 5 SPEEDS				
<i>IMPROVED</i>				
	400 V 3N ~ 50 Hz 44,5 kW	 450 H	6300x985 1860/2200H 895 kg	QK 5960
		 710		QK 5960 AS6
	400 V 3N ~ 50 Hz 6,5 kW 63 kg/h	4350 / 6750 dishes / h	AS6 +600 mm	QK 5960 V
		5100* dishes / h		QK 5960 V AS6
QK 6760 5 SPEEDS				
<i>IMPROVED</i>				
	400 V 3N ~ 50 Hz 57,45 kW	 450 H	7300x985 1860/2200H 1030 kg	QK 6760
		 710		QK 6760 AS6
	400 V 3N ~ 50 Hz 7,45 kW 82 kg/h	5250 / 8100 dishes / h	AS6 +600 mm	QK 6760 V
		6000* dishes / h		QK 6760 V AS6
QK 7760 5 SPEEDS				
<i>IMPROVED</i>				
	400 V 3N ~ 50 Hz 61,5 kW	 450 H	7600x985 1860/2200H 1045 kg	QK 7760
		 710		QK 7760 AS6
	400 V 3N ~ 50 Hz 8,5 kW 87 kg/h	5850 / 9000 dishes / h	AS6 +600 mm	QK 7760 V
		6450* dishes / h		QK 7760 V AS6

- P** Prewash
- W** Wash
- 2R** Double reinforced rinse (pre-rinse + rinse on module)
- 3R+** Reinforced triple rinse with low water consumption: double pre-rinse + rinse on module (reverse osmosis on request)
- AS6** Automatic shower with filter drawer +600 mm
- V** Steam-heated
- *** Productivity according to DIN SPEC 10534 regulation (contact time)

EAC label upon request

Option compatibility to be confirmed by the manufacturer after verification

OPTIONS

Model				AUTOTIMER	PRE DOS	DDE-GROUP	DOS/S	SAN
	220-240 V 3 50 Hz	380-415 V 3N 50 Hz	60 Hz	Autotimer	KROMO disp. connections	Dispensers kit	Dispenser with probe	Sanitization system
QK 2460	+ 2%	●	+ 3%	●	●	€	€	€
QK 2460 AS6	+ 2%	●	+ 3%	●	●	€	€	€
QK 2460 V	+ 1%	●	+ 3%	●	●	€	€	€
QK 2460 V AS6	+ 1%	●	+ 3%	●	●	€	€	€
QK 3760	+ 2%	●	+ 3%	●	●	€	€	€
QK 3760 AS6	+ 2%	●	+ 3%	●	●	€	€	€
QK 3760 V	+ 1%	●	+ 3%	●	●	€	€	€
QK 3760 V AS6	+ 1%	●	+ 3%	●	●	€	€	€
QK 4160	+ 2%	●	+ 3%	●	●	€	€	€
QK 4160 AS6	+ 2%	●	+ 3%	●	●	€	€	€
QK 4160 V	+ 1%	●	+ 3%	●	●	€	€	€
QK 4160 V AS6	+ 1%	●	+ 3%	●	●	€	€	€
QK 5360	+ 2%	●	+ 3%	●	●	€	€	€
QK 5360 AS6	+ 2%	●	+ 3%	●	●	€	€	€
QK 5360 V	+ 1%	●	+ 3%	●	●	€	€	€
QK 5360 V AS6	+ 1%	●	+ 3%	●	●	€	€	€
QK 5960	+ 2%	●	+ 3%	●	●	€	€	€
QK 5960 AS6	+ 2%	●	+ 3%	●	●	€	€	€
QK 5960 V	+ 1%	●	+ 3%	●	●	€	€	€
QK 5960 V AS6	+ 1%	●	+ 3%	●	●	€	€	€
QK 6760	+ 2%	●	+ 3%	●	●	€	€	€
QK 6760 AS6	+ 2%	●	+ 3%	●	●	€	€	€
QK 6760 V	+ 1%	●	+ 3%	●	●	€	€	€
QK 6760 V AS6	+ 1%	●	+ 3%	●	●	€	€	€
QK 7760	+ 2%	●	+ 3%	●	●	€	€	€
QK 7760 AS6	+ 2%	●	+ 3%	●	●	€	€	€
QK 7760 V	+ 1%	●	+ 3%	●	●	€	€	€
QK 7760 V AS6	+ 1%	●	+ 3%	●	●	€	€	€

● Standard

□ Upon request

DDE-GROUP Both detergent (with probe) and rinse-aid dispensers included

DWI Insulation option for the tunnel only, dryer excluded. Shelf dryer can be double skin upon request

	PAP-SAN	DWI	DWI / T	CONNECTIVITY	XP	PAP	DRIVE
Model	Booster pump sanitiz.	Thermoacoustic insulation	Tank insulation	Connectivity (HACCP)	Extra power	Booster pump	Smart drive 5 speeds
QK 2460	€	€	€	€	€	€	●
QK 2460 AS6	€	€	€	€	€	€	●
QK 2460 V	€	€	€	€	□	€	●
QK 2460 V AS6	€	€	€	€	□	€	●
QK 3760	€	€	€	€	€	€	●
QK 3760 AS6	●	€	€	€	€	€	●
QK 3760 V	€	€	€	€	□	€	●
QK 3760 V AS6	●	€	€	€	□	€	●
QK 4160	€	€	€	€	€	€	●
QK 4160 AS6	●	€	€	€	€	€	●
QK 4160 V	€	€	€	€	□	€	●
QK 4160 V AS6	●	€	€	€	□	€	●
QK 5360	●	€	€	€	€	€	●
QK 5360 AS6	●	€	€	€	€	€	●
QK 5360 V	●	€	€	€	€	€	●
QK 5360 V AS6	●	€	€	€	€	€	●
QK 5960	●	€	€	€	€	€	●
QK 5960 AS6	●	€	€	€	€	€	●
QK 5960 V	●	€	€	€	€	€	●
QK 5960 V AS6	●	€	€	€	€	€	●
QK 6760	●	€	€	€	€	€	●
QK 6760 AS6	●	€	€	€	€	€	●
QK 6760 V	●	€	€	€	€	€	●
QK 6760 V AS6	●	€	€	€	€	€	●
QK 7760	●	€	€	€	€	€	●
QK 7760 AS6	●	€	€	€	€	€	●
QK 7760 V	●	€	€	€	□	€	●
QK 7760 V AS6	●	€	€	€	□	€	●

DWI - DWI/T Recommended with KHR10 – KHR20 – KHRP40

CONNECTIVITY Includes HACCP option. 10 year plan

PAP-SAN One standard pump for models QK 5360, QK 5960, QK 6760, QK 7760

XP In case of cold water supply for rinse 8 °C 55 °C, and without any heat recovery, the extra power option is mandatory
In case of cold water supply for rinse (8-15 °C), we recommend to install the heat recovery system as optional.

Option compatibility to be confirmed by the manufacturer after verification

OPTIONS

Model	Master switch	Surface filters	Peak-cut for KROMO dosing	Estimated consumption readout	PI	1-DRAIN
					S/S pumps	Centralized drain
QK 2460	●	●	●	●	€	●
QK 2460 AS6	●	●	●	●	€	●
QK 2460 V	●	●	●	●	€	●
QK 2460 V AS6	●	●	●	●	€	●
QK 3760	●	●	●	●	€	●
QK 3760 AS6	●	●	●	●	€	●
QK 3760 V	●	●	●	●	€	●
QK 3760 V AS6	●	●	●	●	€	●
QK 4160	●	●	●	●	€	●
QK 4160 AS6	●	●	●	●	€	●
QK 4160 V	●	●	●	●	€	●
QK 4160 V AS6	●	●	●	●	€	●
QK 5360	●	●	●	●	€	●
QK 5360 AS6	●	●	●	●	€	●
QK 5360 V	●	●	●	●	€	●
QK 5360 V AS6	●	●	●	●	€	●
QK 5960	●	●	●	●	€	●
QK 5960 AS6	●	●	●	●	€	●
QK 5960 V	●	●	●	●	€	●
QK 5960 V AS6	●	●	●	●	€	●
QK 6760	●	●	●	●	€	●
QK 6760 AS6	●	●	●	●	€	●
QK 6760 V	●	●	●	●	€	●
QK 6760 V AS6	●	●	●	●	€	●
QK 7760	●	●	●	●	€	●
QK 7760 AS6	●	●	●	●	€	●
QK 7760 V	●	●	●	●	€	●
QK 7760 V AS6	●	●	●	●	€	●

● Standard

---- Not available

LANE Only with KDRF69 - KDRF6V

DIV Compulsory for machines > 4,5 m

BT Booster pump included

DVGW Not available with heat recovery and steam condenser
Components prescribed by DVGW on request (check option compatibility with the manufacturer)

	AD	ECO-DET	X-BELT	LANE	DIV	BT	DVGW
Model	Automatic drain	Detergent economizer	Special belt	Cutlery lane	Price for division	Break tank	DVGW
QK 2460	●	●	+ 7 %	----	€	€	€
QK 2460 AS6	●	●	+ 7 %	----	€	€	€
QK 2460 V	●	●	+ 7 %	----	€	€	€
QK 2460 V AS6	●	●	+ 7 %	----	€	€	€
QK 3760	●	●	+ 7 %	----	€	€	€
QK 3760 AS6	●	●	+ 7 %	----	€	€	€
QK 3760 V	●	●	+ 7 %	----	€	€	€
QK 3760 V AS6	●	●	+ 7 %	----	€	€	€
QK 4160	●	●	+ 7 %	+ 5 %	€	€	€
QK 4160 AS6	●	●	+ 7 %	----	€	€	€
QK 4160 V	●	●	+ 7 %	+ 5 %	€	€	€
QK 4160 V AS6	●	●	+ 7 %	----	€	€	€
QK 5360	●	●	+ 7 %	----	€	€	€
QK 5360 AS6	●	●	+ 7 %	----	€	€	€
QK 5360 V	●	●	+ 7 %	----	€	€	€
QK 5360 V AS6	●	●	+ 7 %	----	€	€	€
QK 5960	●	●	+ 7 %	+ 5 %	€	€	€
QK 5960 AS6	●	●	+ 7 %	----	€	€	€
QK 5960 V	●	●	+ 7 %	+ 5 %	€	€	€
QK 5960 V AS6	●	●	+ 7 %	----	€	€	€
QK 6760	●	●	+ 7 %	----	€	€	€
QK 6760 AS6	●	●	+ 7 %	----	€	€	€
QK 6760 V	●	●	+ 7 %	----	€	€	€
QK 6760 V AS6	●	●	+ 7 %	----	€	€	€
QK 7760	●	●	+ 7 %	+ 5 %	€	€	€
QK 7760 AS6	●	●	+ 7 %	----	€	€	€
QK 7760 V	●	●	+ 7 %	+ 5 %	€	€	€
QK 7760 V AS6	●	●	+ 7 %	----	€	€	€

Option compatibility to be confirmed by the manufacturer after verification

OPTIONS

Model	NZ3 Neutral zone 300	NZ6 Neutral zone 600	NZH6 Neutral zone for dryer 600	KDRF69 Shelf dryer	KDRF6V Steam-heated shelf dryer	ID Double skin for dryer	KDRF70 Shelf dryer	KDRF7V Steam-heated shelf dryer	KDRF99M Stage dryer	KDRF9VM Steam heated stage dryer
QK 2460 - QK 2460 AS6	€	€	€	€	----	€	€	----	€	----
QK 2460 V - QK 2460 V AS6	€	€	€	€	€	€	€	€	€	€
QK 3760 - QK 3760 AS6	€	€	€	€	----	€	€	----	€	----
QK 3760 V - QK 3760 V AS6	€	€	€	€	€	€	€	€	€	€
QK 4160 - QK 4160 AS6	€	€	€	€	----	€	€	----	€	----
QK 4160 V - QK 4160 V AS6	€	€	€	€	€	€	€	€	€	€
QK 5360 - QK 5360 AS6	€	€	€	€	----	€	€	----	€	----
QK 5360 V - QK 5360 V AS6	€	€	€	€	€	€	€	€	€	€
QK 5960 - QK 5960 AS6	€	€	€	€	----	€	€	----	€	----
QK 5960 V - QK 5960 V AS6	€	€	€	€	€	€	€	€	€	€
QK 6760 - QK 6760 AS6	€	€	€	€	----	€	€	----	€	----
QK 6760 V - QK 6760 V AS6	€	€	€	€	€	€	€	€	€	€
QK 7760 - QK 7760 AS6	€	€	€	€	----	€	€	----	€	----
QK 7760 V - QK 7760 V AS6	€	€	€	€	€	€	€	€	€	€

---- Not available

* Available only with AS6

NZ3 Recommended with big quantities of trays to wash

NZ6 Recommended for big quantities of trays to wash. Module equipped with a front door

NZH6 Recommended with dryers with blowers

ID Recommended for KDRF69 - KDRF6V. Only for shelf dryer

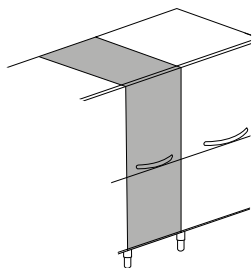

NZ3 + 300 mm
Neutral zone

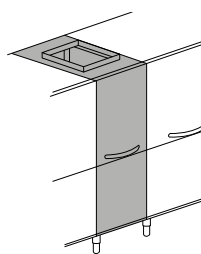

NZ6 + 600 mm
Neutral zone with door

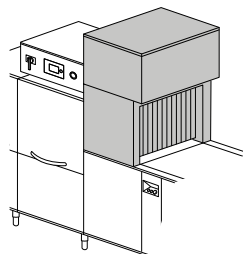

KDRF69 9 kW
Shelf dryer

KDRF6V
Steam heated shelf dryer

KDRF70
Double skin lateral shelf dryer with
upper fan

KDRF7V
Steam-heated double skin shelf lateral
dryer with upper fan

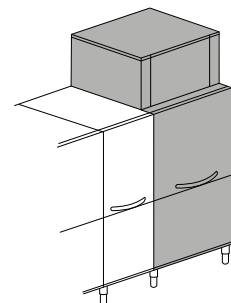

KDRF99M + 900 mm - 9 kW
Dryer module

KDRF9VM + 900 mm
Steam heated dryer module

Model	KDRF99MB	KDRF9VMB	KSCF10	KHRF10	KHRF20	KHRPF40	3R+	3R+ RO	STOCK
	Stage dryer with blowers	Steam heated stage dryer with blowers	Steam condenser	Heat recovery	Heat recovery	Heat recovery	Triple reinforced rinse	Triple reinforced rinse with RO	Chemicals compartment
QK 2460 - QK 2460 AS6	€	----	€	€	€ *	€ *	€	€	€
QK 2460 V - QK 2460 V AS6	€	€	€	€	€ *	€ *	€	€	€
QK 3760 - QK 3760 AS6	€	----	€	€	€	€	€	€	€
QK 3760 V - QK 3760 V AS6	€	€	€	€	€	€	€	€	€
QK 4160 - QK 4160 AS6	€	----	€	€	€	€	€	€	€
QK 4160 V - QK 4160 V AS6	€	€	€	€	€	€	€	€	€
QK 5360 - QK 5360 AS6	€	----	€	€	€	€	€	€	€
QK 5360 V - QK 5360 V AS6	€	€	€	€	€	€	€	€	€
QK 5960 - QK 5960 AS6	€	----	€	€	€	€	€	€	€
QK 5960 V - QK 5960 V AS6	€	€	€	€	€	€	€	€	€
QK 6760 - QK 6760 AS6	€	----	€	€	€	€	€	€	€
QK 6760 V - QK 6760 V AS6	€	€	€	€	€	€	€	€	€
QK 7760 - QK 7760 AS6	€	----	€	€	€	€	€	€	€
QK 7760 V - QK 7760 V AS6	€	€	€	€	€	€	€	€	€

KDRF99M - KDRF9VM

Module with front door

3R+

Reinforced triple rinse: Improved consumptions (with reverse osmosis water on request).

KHRF10 - KHRF20 - KHRPF40

In case of cold water supply for rinse (8-15 °C), we recommend to install the heat recovery system optional.

With osmotic water supply and electrical conductivity lower than 200 microsiemens, it is mandatory to install a stainless steel heat exchanger

Option compatibility to be confirmed by the manufacturer after verification

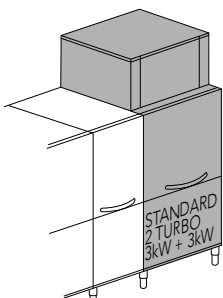

KDRF99MB + 900 mm - 15 kW

Dryer module

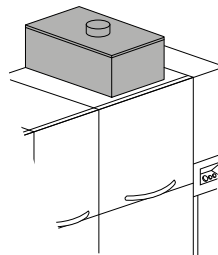

KHRF10

Compact heat recovery

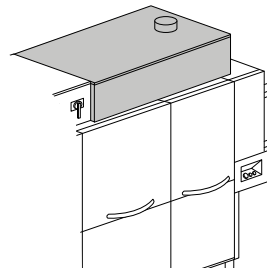

KHRF20

Heat recovery

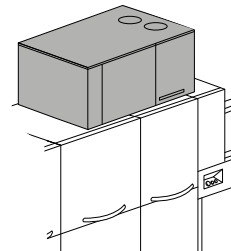

KHRPF40

Heat recovery with heat pump

KDRF9VMB + 900 mm

Steam heated dryer module

KSCF10

Steam condenser

OPTIONS

	MI900	MI1200	MIS1200	MI1500	MI1800	MI2200	MIR2200
Model	Entry mod. 900	Entry mod. 1200	Over. entry mod. 1200	Entry mod. 1500	Entry mod. 1800	Entry mod. 2200	Lowered belt entry mod. 2200
QK 2460 - QK 2460 AS6	€	€	●	€	€	€	€
QK 2460 V - QK 2460 V AS6	€	€	●	€	€	€	€
QK 3760 - QK 3760 AS6	€	€	●	€	€	€	€
QK 3760 V - QK 3760 V AS6	€	€	●	€	€	€	€
QK 4160 - QK 4160 AS6	€	€	●	€	€	€	€
QK 4160 V - QK 4160 V AS6	€	€	●	€	€	€	€
QK 5360 - QK 5360 AS6	€	€	●	€	€	€	€
QK 5360 V - QK 5360 V AS6	€	€	●	€	€	€	€
QK 5960 - QK 5960 AS6	€	€	●	€	€	€	€
QK 5960 V - QK 5960 V AS6	€	€	●	€	€	€	€
QK 6760 - QK 6760 AS6	€	€	●	€	€	€	€
QK 6760 V - QK 6760 V AS6	€	€	●	€	€	€	€
QK 7760 - QK 7760 AS6	€	€	●	€	€	€	€
QK 7760 V - QK 7760 V AS6	€	€	●	€	€	€	€

- Standard
- Upon request
- Not available

Water supply 55 °C. Water hardness min 2°f - max 8°f (if higher, an external water softener is required)
Option compatibility to be confirmed by the manufacturer after verification

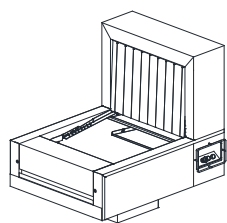

Overhanging entry module

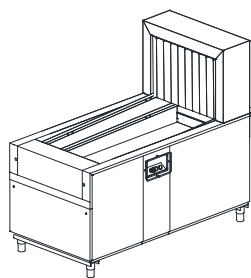

Entry module

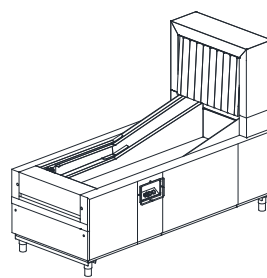

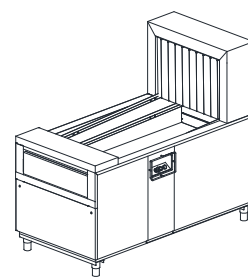

Lowered belt entry module

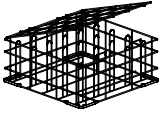

Exit module

	MI2700	MIR2700	EM900	EM1200	EM1500	EM1800	EM2200	EM2700
Model	Entry mod. 2700	Lowered belt entry mod. 2700	Exit mod. 900	Exit mod. 1200	Exit mod. 1500	Exit mod. 1800	Exit mod. 2200	Exit mod. 2700
QK 2460 - QK 2460 AS6	€	€	□	□	□	●	€	€
QK 2460 V - QK 2460 V AS6	€	€	□	□	□	●	€	€
QK 3760 - QK 3760 AS6	€	€	□	□	□	●	€	€
QK 3760 V - QK 3760 V AS6	€	€	□	□	□	●	€	€
QK 4160 - QK 4160 AS6	€	€	□	□	□	●	€	€
QK 4160 V - QK 4160 V AS6	€	€	□	□	□	●	€	€
QK 5360 - QK 5360 AS6	€	€	□	□	□	●	€	€
QK 5360 V - QK 5360 V AS6	€	€	□	□	□	●	€	€
QK 5960 - QK 5960 AS6	€	€	□	□	□	●	€	€
QK 5960 V - QK 5960 V AS6	€	€	□	□	□	●	€	€
QK 6760 - QK 6760 AS6	€	€	□	□	□	□	●	€
QK 6760 V - QK 6760 V AS6	€	€	□	□	□	□	●	€
QK 7760 - QK 7760 AS6	€	€	□	□	□	□	●	€
QK 7760 V - QK 7760 V AS6	€	€	□	□	□	□	●	€

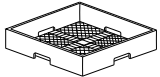
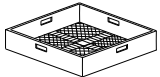
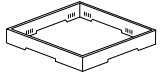
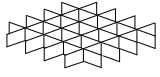
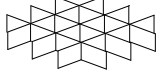
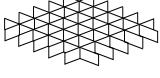
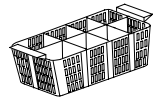
	Description	Capacity	Dimensions	Code	
	REUSABLE CUP BASKET	5x5 Glass 30 < Ø < 90 mm H max 185 mm	500x500x235 H	C 135 	
	NARROW MESH CUTLERY BASKET		500x500x106 H	C 41	
	LARGE MESH BASKET	For glasses	500x500x105 H	C 44	
	HOLDER FOR GLASS SUPPORT	For glass support (C112-C113-C114)	500x500x50 H	C 111	
	GLASS SUPPORT	5x5 Glass Ø 87 mm (C111)	500x500x50 H	C 112	
	GLASS SUPPORT	4x4 Glass Ø 110 mm (C111)	500x500x50 H	C 113	
	GLASS SUPPORT	6x6 Glass Ø 72 mm (C111)	500x500x50 H	C 114	
	CUTLERY BASKET		490x180x140 H	C 47	



The special twin-cord conveyor system, sloped and separated by zone, avoids any contamination among modules and supports the special cold dryer at high pressure. The standard heat recovery uses the steam

produced by the machine to preheat the incoming cold water for immediate energy savings. Thanks to its turbo blowers with custom-made air-blades, this technology allows the immediate re-use of the trays.



SELF-CLEANING

After whole day working in the kitchen, the cleaning and sanitization is one of the most dreaded tasks to accomplish. For this reason, we have conceived a sanitization system which ensures a thorough and immediate cleaning of all machine's surfaces thanks to the special rinse arms installed on the upper wall, thus offering the perfect solution to meet maximum hygiene requirements. A dedicated sanitization product is combined with a booster pump ensuring the right water pressure: the result: spick and span dishwasher!

FEATURES

- Low voltage electronic control panel
- Fast coupling wash-arms, with concave self cleaning nozzles, equipped with flow adjuster
- ACID PROOF AISI 316 wash tanks, with rounded corners to guarantee a perfect hygiene
- The overflow pipe enables the full draining of the wash tanks without removal
- ACID PROOF AISI 316 stainless steel boilers, fully insulated to reduce thermal losses
- Standard heat recovery
- Double skin insulated doors, counter-balanced, equipped with anti-drop safety system
- THERMO BARRIER system for comfortable use
- CLEAN+ filters
- Built-in turbo blowers feed the air nozzles positioned both above and below the twin-cords
- Turbo-blowers. Thanks to a high pressure of the air vortex
- Trays accumulator in the absence of trolley
- Advancement system. Eases the removal of any solid residual on the tray allowing its complete rinse
- Two speeds traction system with built-in clutch. Speed adjuster on request
- Non-return valve
- Autotimer: built-in device that switches the electrical options
- HACCP: data management software on request

Model	Voltage	Capacity	Dimensions	Code
TK 1600	400 V 3N ~ 50 Hz 40,07 kW 8,4 - 13,1 m/min Cold water supply	 Length max: 587 Width max: 370 Depth max: 35	2575x805 2040/2120 H 485 kg	TK 1600

- W** Wash
- R** Single rinse
- TD** Cold dryer with turbo blowers
- H** Heat recovery

OPTIONS

	DDE-GROUP	DOS/S	PAP	DRIVE				
Model	220-240 V 3 50 Hz	380-415 V 3N 50 Hz	60 Hz	Trays accumulator	Dispensers kit	Dispenser with probe	Booster pump	Smart drive
TK 1600	€	●	+3%	●	€	€	€	€

- Standard
- DDE-GROUP** Both detergent (with probe) and rinse-aid dispensers included
- DOS/S** Only for detergent dispenser
- DRIVE** Check voltage compatibility

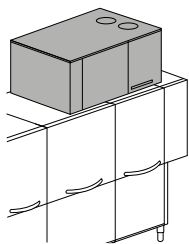

KHRP40

Heat recovery
with heat pump

Model	Capacity	Dimensions	Code
TL 100 TROLLEY FOR TRAYS	 Length max: 587 Width max: 370 Depth max: 35	800x500x900 H 30 kg	TL 100

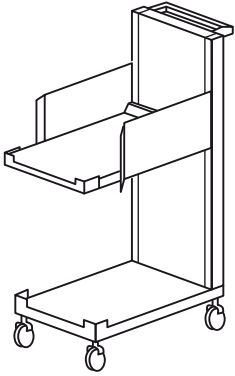

	DWI	HACCP	PI	AUTOTIMER	KHR5	KHRP40	SAN	PAP-SAN
Model	Thermoacoustic insulation	HACCP supervisor	S/S pumps	Autotimer	Heat recovery	Heat recovery with heat pump	Sanitization system	Booster pump sanitiz.
TK 1600	€	€	€	●	●	€	€	€

KHR5 Heat recovery (cold water supply 8-15°C)

DWI Insulation option for the tunnel only, dryer excluded.

HACCP Software and cables included

KHRP40 In alternative to standard compact heat recovery

Division not available

Water supply 55 °C. Water hardness min 2°f - max 8°f (if higher, an external water softener is required)

Option compatibility to be confirmed by the manufacturer after verification







We recommend to install the machine in a well ventilated room, with a properly sized steam exhausting system

EAC label upon request

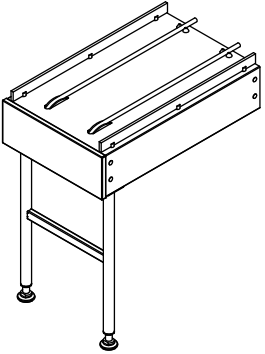

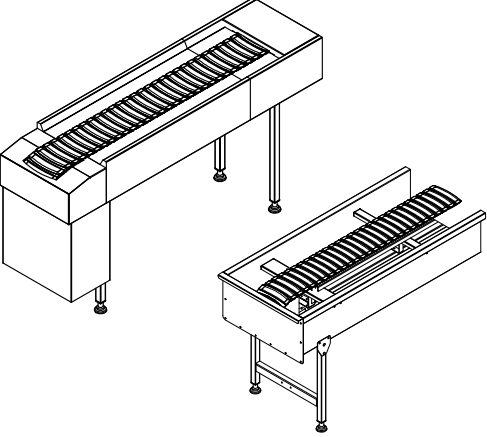
Our customized bi-cord transport system is the perfect solution not only to carry, but also to wash and deliver trays. The system limits the workers operations and contains management costs and space while perfectly drying the trays for an immediate use.

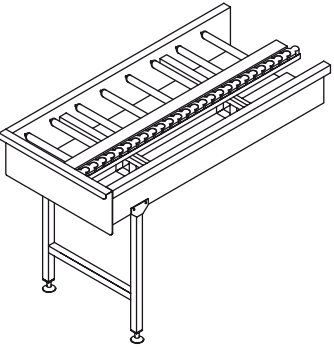
With the recent expansion of the range, KROMO now offers tailor-made logistics and waste treatment solutions. Thanks to this comprehensive offer, even the most specific customer needs can be satisfied.

Model	Voltage	Capacity	Code	
<p>CORD CONVEYOR</p> 	<p>400 V 3N 50 Hz -- 230 V 50 Hz -- 230 V 3 50 Hz Special voltages on request</p>	<p> 530x325x35 H</p>	<p>BCC</p>	<p>upon request</p>
<p>SLAT CONVEYOR FOR TRAYS OR RACKS</p> 	<p>400 V 3N 50 Hz -- 230 V 50 Hz -- 230 V 3 50 Hz Special voltages on request</p>	<p> 530x325x35 H</p> <p> 500x500</p>	<p>SCT trays</p> <p>SCR racks</p>	<p>upon request</p> <p>upon request</p>
<p>CARDAN CHAIN CONVEYOR</p> 	<p>400 V 3N 50 Hz -- 230 V 50 Hz -- 230 V 3 50 Hz Special voltages on request</p>	<p> 500x500</p>	<p>CCC</p>	<p>upon request</p>



The technology of the POT line will lead you in an easy and intuitive way, through the functions of your POT washer, directly from the control panel. The TFT color display (KP 152 EL PLUS / KP 202 EL PLUS / KP 302 EL PLUS / KP 402 EL PLUS / KP MAXXI PLUS) eases the visualization of the working temperatures and the set wash cycles, both easily modifiable. With the new motorized valve implemented on the KP 202 EL PLUS, KP 302 EL PLUS and KP 402 EL PLUS, together with the possibility of scheduling

the start of the cycle, we greatly facilitated the use and maintenance of these models. The two-level self-diagnosis system, also presented on the KP 152 EL PLUS / HOOD 130 KP MAXXI PLUS, reports any anomaly very accurately. Besides, the optimized Optimal Rinse rinsing system, the additional Energy Saving function, the high-level performance and high quality of our materials, the competitiveness and versatility of our POT range reach levels that are hard to gain on the market.

IMPROVED



FEATURES KP 76 EL - KP 86 EL PLUS

- High capacity in small dimensions
- Trays (600x400 mm with 90° angle) and EURONORM crates 600x400x400H
- Versatility of use
- Double skin
- Soft door opening in two-step
- Deep-formed tank
- Triple pump filter (KP 76 EL)
- Four customizable wash cycles
- Automatic self-cleaning cycle
- New intuitive electronic control panel with displayed wash and rinse temperatures
- Intuitive START button with multicolour backlight for a quick visualization of the machine status
- Built-in peristaltic rinse-aid dispenser with dosage setting directly from the control panel (KP 86 EL PLUS)
- PLUS system for a constant rinse (KP 86 EL PLUS)
- Soft Start wash pump (KP 76 EL)
- Built-in water softener available with automatic regeneration cycle (KP 76 EL)
- CONNECTIVITY remote control compliant with the HACCP norms (on request)

FEATURES KP MAXXI PLUS

STANDARD

- Basket 600 x 500 mm
- Useful height 450 mm
- 6 wash cycles: 4 customizable cycles
- Easy and intuitive electronic control panel
- Double skin insulated hood
- Deep tank
- Double tank filters, with dirt collection system and pump filter (improved system for a better filtration of the wash water)
- Self-cleaning vertical pump
- Water consumption and working time control system
- Easy to access for maintenance
- Anti-drop roof panel
- Easily removable basket support
- Linear or corner layouts
- Self-cleaning cycle
- The PLUS system grants a constant rinse temperature and pressure
- Peristaltic rinse aid dispenser included with dosage adjustable from the control panel

OPTIONS

- ENERGY SAVING HR system: heat recovery and steam condenser
- D: built-in water softener
- CONNECTIVITY remote control compliant with the HACCP norms
- Remote control panel available on request instead of the standard control panel (PLUS versions)
- Predisposition for connection to an external device of reverse osmosis





FEATURES KP 151 EL

- LED control panel with four programmable cycles
- Max loading 805 mm
- Double skin door
- Deep-formed tank
- Double tank filter + pump filter
- Standard booster pump
- Anti-drop roof panel
- Automatic Self-cleaning cycle
- Basket 550x665 mm
- Stainless steel wash and rinse arms



NEW ELECTRONIC CONTROL PANEL

- LED electronic control panel
- Intuitive START button with multi-color backlight for quick viewing of machine status
- Display of wash and rinse temperatures, cycle progress, selected cycle, machine status (stand-by, end of cycle, etc.) and main warnings description (door opening, drainage, etc.)
- Language selection not available
- 4 programmable cycles (2 - 4 - 6 - 8 minutes)
- CONNECTIVITY remote control compliant with the HACCP norms (on request)



FEATURES KP 152 EL PLUS - KP 202 EL PLUS - KP 302 EL PLUS - KP 402 EL PLUS

- Electronic with energy saving system
- Double skin
- Standard rinse pump
- Self-cleaning vertical pump
- Deep formed stepped tank
- Stainless steel independent wash/rinse arms
- Double tank filter with dirt collection system
- Thermostop to grant the rinse temperature according to HACCP regulations
- Multichromatic START key
- Automatic self-cleaning cycle
- Standard peristaltic rinse-aid dispenser
- Four customizable wash cycles
- The wash pump activate one after the other to reduce the electric peak (KP 202 EL PLUS / KP 302 EL PLUS / KP 402 EL PLUS)
- Double skin door that can be used as a countertop
- Innovative drain valve system (KP 202 EL PLUS / KP 302 EL PLUS / KP 402 EL PLUS) for automatized drain
- 5" TFT touch display with soft touch membrane keys
- Optional heat recovery (HR)
- CONNECTIVITY remote control compliant with the HACCP norms (on request)

CONNECTIVITY 4.0 & APP

WHEREVER YOU ARE...
YOUR DISHWASHER, JUST A CLICK AWAY

You will be constantly connected to the machine to monitor the work phases, review any eventual alarm and configure remotely the operating parameters according to your needs. Compliant with HACCP norms. Thanks to our brand new App, you will have access to connected machines and all commercial and technical documentation.

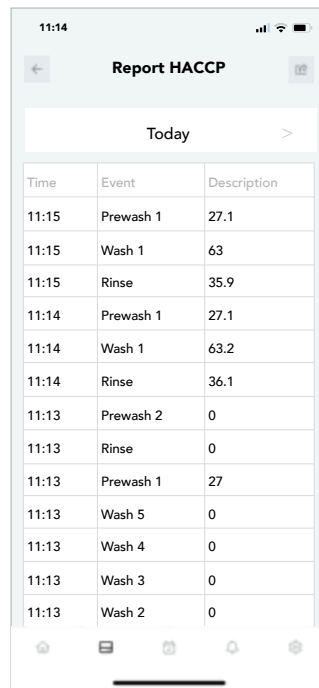
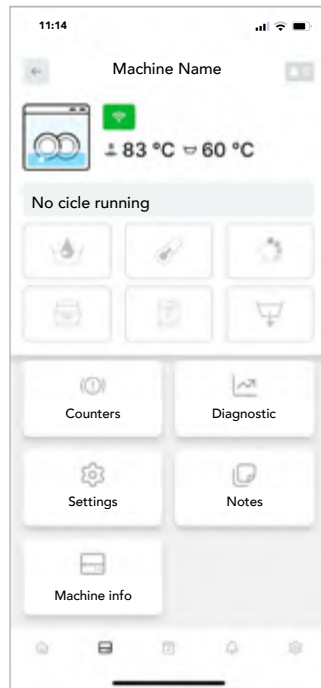

View all the working parameters and event records, working hours and any problem at any time.



In case of problem, the machine promptly alerts you. The technician can intervene remotely to solve the problem or anticipate the needed parts for an on-site intervention.



A daily activity report is available with all the events related to the dishwasher in a detailed spreadsheet with HACCP data.



Our Connectivity system is a revolutionary device limiting and facilitating the eventual intervention of a technician who can anticipate the necessary parts to be replaced, saving time and money.



STEAM RECOVERY



ENERGY SAVINGS



SUSTAINABILITY



HR:

HEAT RECOVERY SYSTEM

With the KROMO warewashing models KP 152 EL HR PLUS / KP 202 EL HR PLUS / KP 302 EL HR PLUS / KP 402 EL HR PLUS / KP MAXXI HR PLUS / KP MAXXI PLUS, up to 50% of energy costs can be saved!

The HR system is a heat exchanger: the moist warm water vapour is drawn directly out of the machine when the door is closed, and used for pre-heating the cold water supplied up to around 50°C. As a result, the energy required to reach the final rinse temperature (approx. 85°C) is dramatically reduced.

Depending on the model you can save between 3,5k Wh and 5,5k Wh.









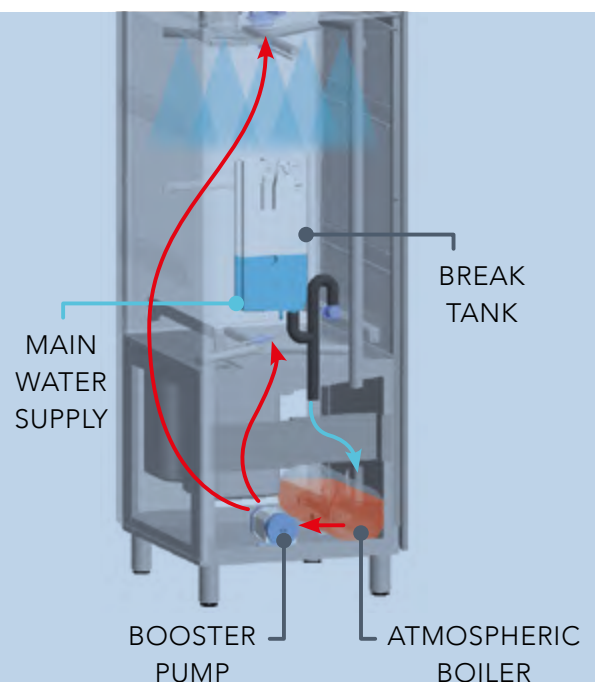

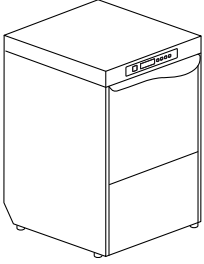





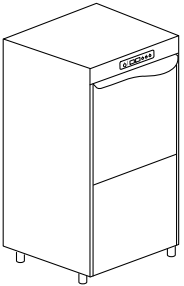

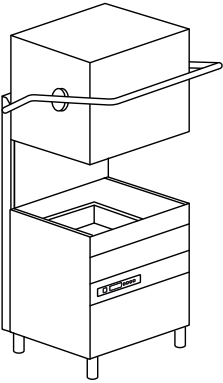

KROMO HR technology improves the room's air quality and climate as well. The heat exchanger reduces the exhaust air temperature by more than an half.

The entire humidity volume is cut down by approx. -20% of the equivalent machine without a heat recovery unit. This permanently improves the operators' comfort.











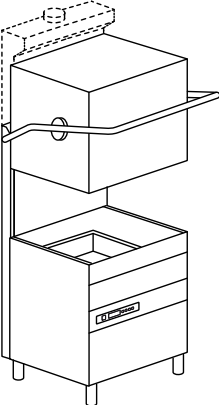

PLUS SYSTEM

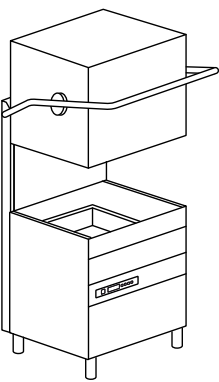



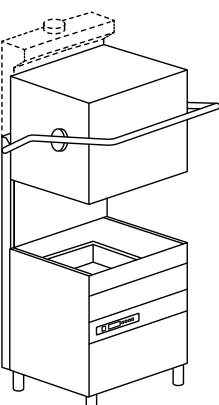

The rinse cycle is stabilized at 85°C temperature and flows at a constant pressure, thanks to the atmospheric boiler which avoids to add fresh water from the mains, when rinsing. Moreover the PLUS System grants a better control and a correct dosage of rinse-aid at every cycle.



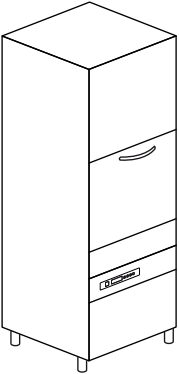

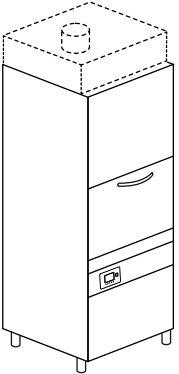

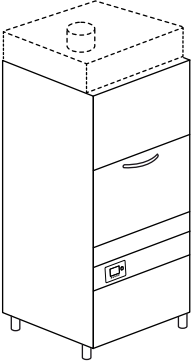

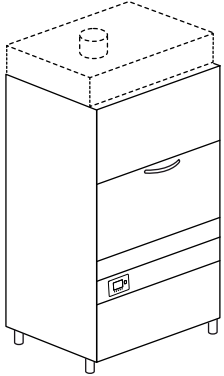

Model		Voltage	Capacity	Dimensions	Code
KP 76 EL 4 PROGRAMS					
	<p>RACK EQUIPMENT 1 X 575005 1 X C44 1 X C86/A 1 X 575010</p> 	<p>Multivoltage Standard 400 V 3N 50 Hz 6,7 kW or 230 V 3 50 Hz 6,7 kW or 230 V 50 Hz 6,7 kW</p>	<p> 400 H</p> <p> Ø 400</p> <p> 500x500</p>	<p>600x680x850 H 68 kg</p> <p> 600x400x25 H</p> <p> 600x400x400 H</p> <p>Surface filters</p>	<p>KP 76 EL</p> <p>KP 76 EL DA</p>
KP 86 EL PLUS 4 PROGRAMS					
IMPROVED 	<p>RACK EQUIPMENT 1 X 575005 1 X 575010 1 X C132 1 X C86/A</p> 	<p>Multivoltage Standard 400 V 3N 50 Hz 10,12 kW or 230 V 3 50 Hz 10,12 kW or 230 V 50 Hz 10,12 kW</p>	<p> 440 H</p> <p> 500x500</p> <p> 500x610</p>	<p>600x700x1380 H</p> <p>100 kg</p> <p> 600x400x25 H</p>	<p>KP 86 EL PLUS</p>
KP MAXXI PLUS ELECTRONIC 4 PROGRAMS					
	<p>RACK EQUIPMENT 1 X C136 1 X C137 1 X C86/A 1 X C139</p> 	<p>400 V 3N ~ 50 Hz 10,5 kW</p>	<p> 450 H</p> <p> 310 < Ø < 410**</p> <p> 500x600</p> <p> 500x600</p> <p> 500x600</p>	<p>800x735x 1490/1961 H 120 kg</p> <p> 600x400x25 H</p>	<p>KP MAXXI PLUS</p> <p>KP MAXXI PLUS DA</p>

** With DW138 basket, plate diameter: from 310 mm to 410 mm
 Without DW138 basket, maximum plate diameter 310 mm

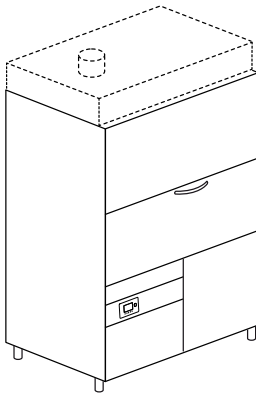
Model	Voltage	Capacity	Dimensions	Code	
KP MAXXI HR PLUS ELECTRONIC 4 PROGRAMS - HR: HEAT RECOVERY					
	<p>RACK EQUIPMENT 1 X C136 1 X C137 1 X C86/A 1 X C139</p>	<p>400 V 3N ~ 50 Hz 10,5 kW</p>	 450 H	<p>800x735x2162 H 150 kg</p>	KP MAXXI HR PLUS
			<p>310 < Ø < 410**</p>  500x600  500x600  500x600		
KP MAXXI PLUS LIFT ELECTRONIC 4 PROGRAMS					
	<p>RACK EQUIPMENT 1 X C136 1 X C137 1 X C86/A 1 X C139</p>	<p>400 V 3N ~ 50 Hz 10,5 kW</p>	 450 H	<p>800x735x 1490/1961 H 120 kg</p>	KP MAXXI PLUS LIFT
			<p>310 < Ø < 410**</p>  500x600  500x600  500x600		
KP MAXXI HR PLUS LIFT ELECTRONIC 4 PROGRAMS - HR: HEAT RECOVERY					
	<p>RACK EQUIPMENT 1 X C136 1 X C137 1 X C86/A 1 X C139</p>	<p>400 V 3N ~ 50 Hz 10,5 kW</p>	 450 H	<p>800x735x2162 H 150 kg</p>	KP MAXXI HR PLUS LIFT
			<p>310 < Ø < 410**</p>  500x600  500x600  500x600		

Model		Voltage	Capacity	Dimensions	Code
KP 151 EL 4 PROGRAMS					
	<p>RACK EQUIPMENT</p> <ul style="list-style-type: none"> 1 X C86/A 1 X C87/B 1 X C97/A 1 X C100 	400 V 3N ~ 50 Hz 8,2 kW	 805 H  550x665	650x750x1690/2060H 110 kg	KP 151 EL
KP 152 EL PLUS 4 PROGRAMS - HR: HEAT RECOVERY					
	<p>RACK EQUIPMENT</p> <ul style="list-style-type: none"> 1 X C86/A 1 X C87/B 1 X C97/A 1 X C100 	400 V 3N ~ 50 Hz 8,2 kW	 805 H  550x665	690x800x1890/2275 H 155 kg 690x800x2165/2275 H 165 kg	KP 152 EL PLUS KP 152 EL HR PLUS
KP 202 EL PLUS 4 PROGRAMS - HR: HEAT RECOVERY					
	<p>RACK EQUIPMENT</p> <ul style="list-style-type: none"> 1 X 91100 1 X C86/A 1 X C97/A 	400 V 3N ~ 50 Hz 12,5 kW	 645 H  700x700	840x885x1790/2050 H 199 kg 840x885x2140 H 215 kg	KP 202 EL PLUS KP 202 EL HR PLUS

Model	Voltage	Capacity	Dimensions	Code
KP 302 EL PLUS 4 PROGRAMS - HR: HEAT RECOVERY				
	<p>RACK EQUIPMENT 1 X 92100 1 X C86/A 1 X C97/A</p> 	<p>400 V 3N ~ 50 Hz 13,4 kW</p>	 645 H	<p>990x885x1790/2050 H 221 kg</p> <p>KP 302 EL PLUS</p>
			 850x725	<p>990x885x2140 H 237 kg</p> <p>KP 302 EL HR PLUS</p>
KP 402 EL PLUS 4 PROGRAMS - HR: HEAT RECOVERY				
	<p>RACK EQUIPMENT 1 X 93600 1 X C86/A 1 X C97/A</p> 	<p>400 V 3N ~ 50 Hz 14,8 kW</p>	 800 H	<p>1490x885x1970/2295 H 340 kg</p> <p>KP 402 EL PLUS</p>
			 800 H	<p>1490x885x2310 H 362 kg</p> <p>KP 402 EL HR PLUS</p>
			 1350x725	<p>1490x885x1970/2295 H 340 kg</p> <p>KP 402 EL V</p>
			<p>400 V 3N ~ 50 Hz 5,8 kW 25 kg/h</p>	<p>1490x885x2310 H 362 kg</p> <p>KP 402 EL V HR</p>

OPTIONS

Model	220-240V 50 Hz		380-415V 3N50Hz		220-240V 350 Hz		380-415V 350 Hz		60Hz	440V3 60Hz	XP	PS	TS	SA	CONTROL
	M	●	M	----	€	----	€	----	€	€	Extra power	Drain pump	Thermostop system	Automa- tized drain	Substitute remote control panel
KP 76 EL	M	●	M	----	€	----	€	----	€	€	----	€	●	----	----
KP 76 EL DA	M	●	M	----	€	----	€	----	€	€	----	€	●	----	----
KP 86 EL PLUS	M	●	M	----	€	----	€	----	€	€	----	€	●	----	----
KP MAXXI PLUS	----	●	□	€	€	€	€	€	€	€	€	€	●	----	€
KP MAXXI PLUS DA	----	●	□	€	€	€	€	€	€	€	€	€	●	----	€ €
KP MAXXI PLUS LIFT	----	●	□	€	€	€	€	€	€	€	€	€	●	----	€ €
KP MAXXI PLUS LIFT DA	----	●	□	€	€	€	€	€	€	€	€	€	●	----	€ €
KP MAXXI HR PLUS	----	●	□	€	€	€	€	€	€	€	€	€	●	----	€ €
KP MAXXI HR PLUS DA	----	●	□	€	€	€	€	€	€	€	€	€	●	----	€ €
KP MAXXI HR PLUS LIFT	----	●	□	€	€	€	€	€	€	€	€	€	●	----	€ €
KP MAXXI HR PLUS LIFT DA	----	●	□	€	€	€	€	€	€	€	€	€	●	----	€ €
KP 151 EL*	----	●	□	€	€	----	€	€	€	€	€	€	●	----	----
KP 152 EL PLUS	----	●	□	€	€	----	€	€	€	€	€	€	●	----	----
KP 152 EL HR PLUS	----	●	□	€	€	----	€	€	€	€	€	€	●	----	----
KP 202 EL PLUS	----	●	□	€	€	----	€	€	€	€	€	€	●	●	----
KP 202 EL HR PLUS	----	●	□	€	€	----	€	€	€	€	€	€	●	●	----
KP 302 EL PLUS	----	●	□	€	€	----	€	€	€	€	€	€	●	●	----
KP 302 EL HR PLUS	----	●	□	€	€	----	€	€	€	€	€	€	●	●	----
KP 402 EL PLUS	----	●	□	€	€	----	€	€	€	€	€	€	●	●	----
KP 402 EL HR PLUS	----	●	□	€	€	----	€	€	€	€	€	€	●	●	----
KP 402 EL V	----	●	□	€	€	----	€	€	€	€	€	€	●	●	----
KP 402 EL V HR	----	●	□	€	€	----	€	€	€	€	€	€	●	●	----

- Standard
- Upon request
- Not available
- M** Multivoltage
- DA** Built-in water softener with automatic regeneration
- V** Steam heated
- * All models are equipped with double skin, except KP 151 EL
- PLUS** Rinse with constant temperature and stabilized consumption

Water supply 55 °C (not on HR version for KP 152 EL HR PLUS, KP 202 EL HR PLUS, KP 302 EL HR PLUS, KP 402 EL HR PLUS, KP 402 EL V HR, KP all versions HR MAXXI PLUS). Water hardness min 2°f - max 8°f (if higher, an external water softener is required)

EAC label upon request

Option compatibility to be confirmed by the manufacturer after verification

220-240 V 50 HZ For KP 86 EL PLUS max boiler heating element 6000 W

Model	DDE	DB	DBE	CONN.	BT	WRAS	DVGW	PAP	PI	FLOAT	DF
	Detergent dispenser	Rinse-aid dispenser	Peristaltic rinse-aid disp.	Connectivity (HACCP)	Break tank	Wras	DVGW	Booster pump	S/S pumps	Probes lack det. and rinse aid	Surface filters Kit
KP 76 EL	€	●	€	€	€	€	----	€	----	€	€
KP 76 EL DA	€	●	€	€	----	€	----	€	----	€	€
KP 86 EL PLUS	€	----	●	€	●	€	€	●	----	€	----
KP MAXXI PLUS	€	----	●	€	●	€	€	●	----	€	----
KP MAXXI PLUS DA	€	----	●	€	----	€	€	●	----	€	----
KP MAXXI PLUS LIFT	€	----	●	€	●	€	€	●	----	€	----
KP MAXXI PLUS LIFT DA	€	----	●	€	----	----	€	●	----	€	----
KP MAXXI HR PLUS	€	----	●	€	●	€	----	●	----	€	----
KP MAXXI HR PLUS DA	€	----	●	€	----	€	----	●	----	€	----
KP MAXXI HR PLUS LIFT	€	----	●	€	●	----	----	●	----	€	----
KP MAXXI HR PLUS LIFT DA	€	----	●	€	----	----	----	●	----	€	----
KP 151 EL*	€	●	€	€	----	----	----	●	----	€	----
KP 152 EL PLUS	€	----	●	€	●			●	----	€	----
KP 152 EL HR PLUS	€	----	●	€	●	----	----	●	----	€	----
KP 202 EL PLUS	€	----	●	€	●	€	€	●	€	€	----
KP 202 EL HR PLUS	€	----	●	€	●	----	----	●	€	€	----
KP 302 EL PLUS	€	----	●	€	●			●	€	€	----
KP 302 EL HR PLUS	€	----	●	€	●	----	----	●	€	€	----
KP 402 EL PLUS	€	----	●	€	●			●	----	€	----
KP 402 EL HR PLUS	€	----	●	€	●	----	----	●	----	€	----
KP 402 EL V	€	----	●	€	----	----	----	●	----	€	----
KP 402 EL V HR	€	----	●	€	----	----	----	●	----	€	----

- PS** Not available with 380-415 V 3 50 Hz and 440 V 3 60 Hz
- PI** Available with 50 Hz frequency only
- BT** Booster pump included
- XP** In case of cold water supply for rinse 8 °C 55 °C, and without any heat recovery, the extra power option is mandatory. + 3000 W with standard voltage only, for other voltages please contact us. In case of cold water supply for rinse 8-15 °C, We recommend the heat recovery as option.
- WRAS - DVGW** Booster pump included. KP 76 EL machine depth +20 mm
- DVGW** Components prescribed by DVGW on request (check option compatibility with the manufacturer)
- CONNECTIVITY** Includes HACCP option. 10 year plan
- HR** Heat recovery (in case of cold water supply 8-15 °C)
The ENERGY RECOVERY system uses the heat produced by the machine to preheat the infeed of cold rinse water supply (8-15 °C)
Optimal air temperature in the dishwashing area thanks to the reduction of the steam and the humidity produced by the machine
HR possible in case of osmotic water supply, if the electrical conductivity is higher than 200 microsiemens

	Description	Capacity	Dimensions	Code	
	PLATE BASKET	Standard 22 plates Ø < 310 mm	600x500x115 H	C 136	
	LARGE MESH BASKET	Standard	600x500x115 H	C 137	
	TRAYS OR PLATES BASKET	12 trays up to 47 cm wide or for 10 GN1/1 (max depth 2,5 cm) or 11 plates 310 < Ø < 410 mm (max depth 2,5 cm)	600x500x115 H	C 138	
	NARROW MESH CUTLERY BASKET		500x500x106 H	C 41	
	LARGE MESH BASKET	For glasses	500x500x105 H	C 44	
	REUSABLE CUP BASKET	KP 76 EL KP 86 EL PLUS	500x500x235 H	C 135 	

	Description	Capacity	Dimensions	Code	
	GRIDDLES Basket holder 2 pcs max depth 80 mm	KP 76 EL KP 86 EL PLUS	500x500x380 H	575005/P	
	GRIDDLES	KP 76 EL KP 86 EL PLUS KP 151 EL KP 152 EL PLUS	500x500 550x550	575010 C 100	
	STAINLESS STEEL BASKETS	KP 86 EL PLUS KP 151 EL - KP 152 EL PLUS KP 202 EL PLUS KP 302 EL PLUS KP 402 EL PLUS	500x610x75 H 550x665x75 H 700x700x150 H 850x725x130 H 1350x725x130 H	C 132 C 87/B 91100 92100 93600	
	TRAY SUPPORTS 6 pcs max depth 25 mm	KP 76 EL KP 86 EL PLUS	500x500x160 H	575005	
	TRAYS BASKET	Standard 6 pcs max depth 2,5 cm	620x500x160 H	C 139	
	SAUCER HOLDER	12 saucers	300x100x90 H	10728	
	CUTLERY BASKET		110x110x120 H	15060	

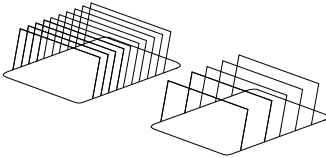
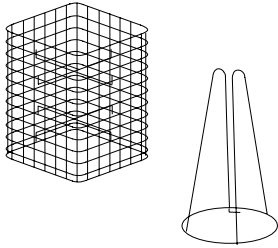
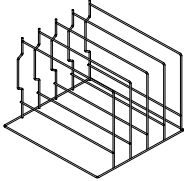
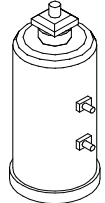
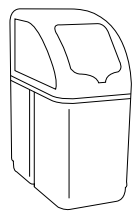
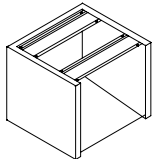
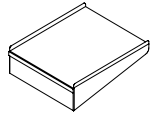
	Description	Capacity	Dimensions	Code	
	TRAY SUPPORTS 8 pcs max depth 25 mm	KP 151 EL KP 152 EL PLUS KP 202 EL PLUS KP 302 EL PLUS KP 402 EL PLUS	300x465x210 H	C 97/A	
	TRAY SUPPORTS 4 pcs max depth 65 mm or GN1/1 600x400 max depth 65 mm			C 97/B	
	SPATULA BASKET		150x150x250 H	C 86/A	
			220x220x420 H	C 85/A	
	KNIFE HOLDER INSERT	KP 202 EL PLUS KP 302 EL PLUS KP 402 EL PLUS Capacity 15 knife holders dim 360 x 175 x 480 H	660x610x500H	C 146	
	WATER SOFTENER	12 l	Ø 200x500 H	DEP 12	
	AUTOMATIC WATER SOFTENER	12 l (max 800 l)	315x510x685 H	DEP 12-AUT	
	STAINLESS STEEL STAND	KP 76 EL Stainless steel stand for undercounter 500 x 500	592x535x500 H	999900517	
	SHELF	Only for exit (line implementation for KP MAXXI PLUS)	600x510	K 2ME *	

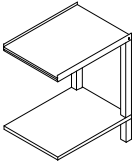
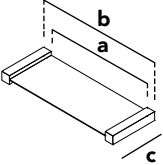
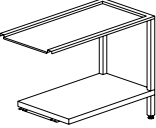
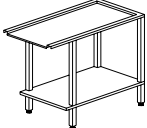
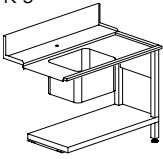
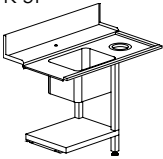
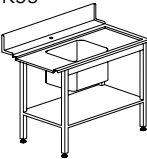
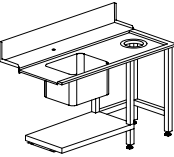
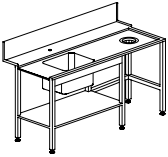
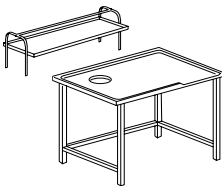
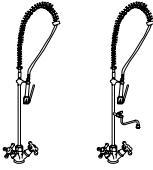
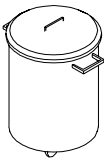
	Description	Capacity	Dimensions	Code	
	TABLE	(line implementation for KP MAXXI PLUS)	650x510x860 H	K 4/65 *	
	HOOD CONNECTION SHELF		a: 510 b: 590 c: 239	KIT DUO	
K 4/70 B - K 4/120 B	K 4B	TABLE (line implementation for KP MAXXI PLUS)*	700x590x860 H 1200x590x860 H 1200x590x860 H	K 4/70B * K 4/120B * K 4B **	
 					
K 5	K 5F	K55	Sink 500x400x270 H (line implementation for KP MAXXI PLUS)*	1200x730x860 H 1200x730x860 H 1200x730x860 H	K 5 * K 5F * K 55 **
  					
K 8 E	K 8 - K 9	Sink 500x400x270 H (line implementation for KP MAXXI PLUS)*	1500x730x860 H 1500x730x860 H 1800x730x860 H	K 8 ** K 8E * K 9 **	
 					
	SHELF		1515x620x660 H 2315x620x660 H	K 7M16 *** K 7M24 ***	
	GRADING TABLE WITH RUBBER RING	Waste hole and special dimensions upon request	1600x1000x850 H 2400x1000x850 H	K 7A/1600 *** K 7A/2400 ***	
	FLEXIBLE SHOWER complete with mixing group and lever tap, to be fixed to the wall		1000 H	K 1	
	FLEXIBLE SHOWER complete with mixing group and lever tap, to be fixed to the wall and intermediate tap		1000 H	K 1HR	
	STAINLESS STEEL WASTE BIN	Basic model	Ø 400x570 H	K 7/1	
		With wheels	Ø 400x570 H	K 7/2	
		With wheels and pedal board	Ø 400x570 H	K 7/3	

** Wooden cage +2% minimum + € / ■ Special dimensions for tables upon request / Tables shown in right-to-left version
* Standard tables for linear installations. For tables positioned in front of the machine, a special table must be designed. Do not hesitate to contact us for more information.



2 in 1: AQUAFORCE, the ultimate warewashing technology! This innovative product features unique solutions: a high pressure utensil washer and a hood-type dishwasher.

The cleaning power of high-pressure water jets guarantees excellent results in few minutes without the need of granules and soaking. Our versatile utensil washer goes beyond cleaning trays: it is also perfectly suited to wash dishes. Equipped with dedicated programs, it guarantees effective and hygienic cleaning, making it an ideal choice for professional kitchens that demand high efficiency and monitored operation. In terms of sustainability,

AQUAFORCE offers significant savings in detergent and time, thanks to the innovative PLUS system that minimizes water, energy, and chemical consumption. It delivers outstanding results even against the most stubborn dirt and quick turnaround of kitchenware, maximizing productivity. By automating tasks that previously required soaking and hand washing, our AQUAFORCE allows kitchen staff to focus on other important duties. Designed to meet the demanding needs of canteens, caterers, airports, and restaurants, it provides excellent value by saving both time and money while maintaining top cleanliness standards.

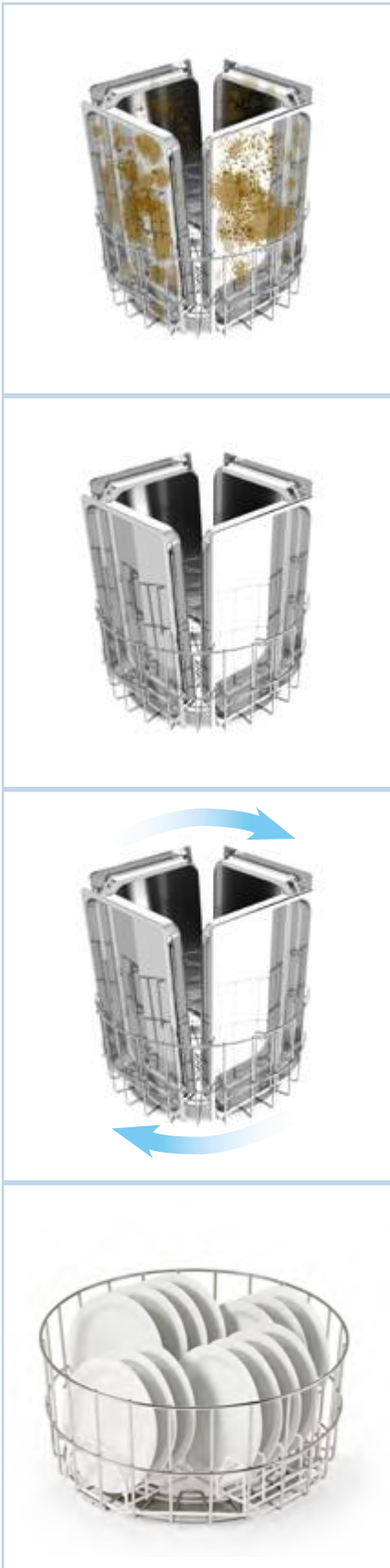

FEATURES

STANDARD

- Double skin
- Compact size: smaller than a warewasher, slightly wider than a standard hood type model!
- 2 FUNCTIONS:
 - - tray/pan washer version with high pressure jet: for burnt or furred up GN trays or pans
 - - dishwasher version: to wash dishes like a classic hood type model
- 1 x high pressure wash pump for trays
- 1 low pressure wash pump for dishes
- 5" TFT color display
- 8 wash programs:
 - 4 cycles for trays
 - 4 cycles for plates
- Final step after rinse: "spinning" function (fast basket's rotation) to help remove water from pans and trays
- Hood opening with useful height of 55 cm
- Tank and boiler in AISI 316
- Our PLUS system grants a constant rinse temperature and pressure
- Built-in peristaltic rinse-aid dispenser
- Self cleaning cycle
- Break Tank

OPTIONS

- Remote display (replacing the lower door one)
- HR Heat recovery steam condensing unit for cold water supply
- Exhaust fan (on the version without HR)
- LIFT: automatic hood lift at the end of the cycle
- Automatized drain
- Drain pump
- Built-in peristaltic detergent dispenser
- WRAS or DVGW

CONNECTIVITY 4.0 & APP

WHEREVER YOU ARE...
YOUR DISHWASHER, JUST A CLICK AWAY

You will be constantly connected to the machine to monitor the work phases, review any eventual alarm and configure remotely the operating parameters according to your needs. Compliant with HACCP norms. Thanks to our brand new App, you will have access to connected machines and all commercial and technical documentation.

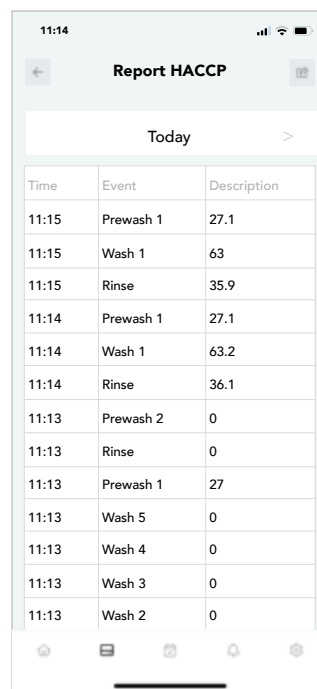
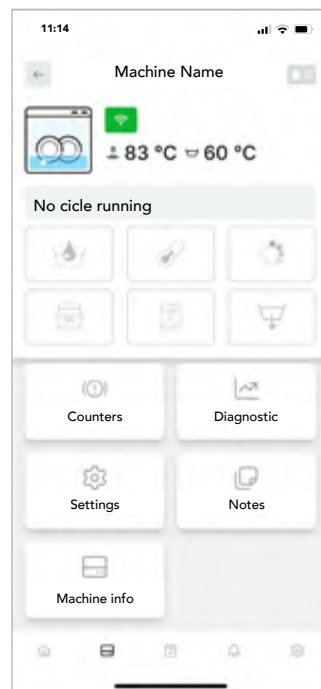

View all the working parameters and event records, working hours and any problem at any time.



In case of problem, the machine promptly alerts you. The technician can intervene remotely to solve the problem or anticipate the needed parts for an on-site intervention.



A daily activity report is available with all the events related to the dishwasher in a detailed spreadsheet with HACCP data.



Our Connectivity system is a revolutionary device limiting and facilitating the eventual intervention of a technician who can anticipate the necessary parts to be replaced, saving time and money.

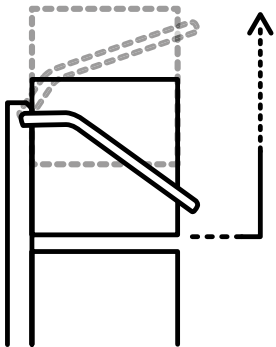

IMPROVED LIFT SYSTEM:

AUTOMATIC TWO-STEP HOOD LIFT AT THE END OF THE CYCLE

The hydraulic system has been replaced by an electric motor. Its simplicity limits maintenance and the formation of limescale. The latter, freeing up space, allows to add more options to the LIFT models.

PLUS SYSTEM

GUARANTEED RINSE EVEN WITH LOW PRESSURE OF THE WATER INLET

We have developed an innovative rinsing system at constant temperature, consumption and water pressure, regardless of external conditions. The PLUS System ensures optimal and constant rinsing performance thanks to the combination of Break Tank, atmospheric boiler and rinse pump.

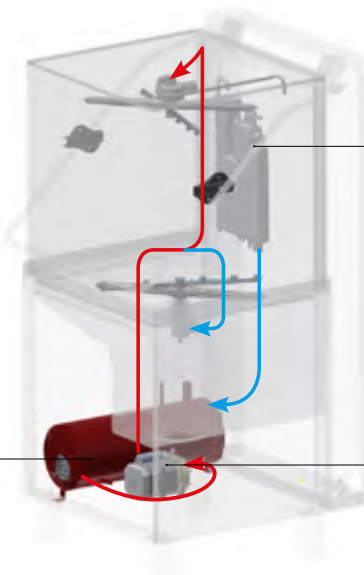

BREAK TANK

The Break Tank system prevents the heated water of the boiler to go back and mix with the fresh water supply.

ATMOSPHERIC BOILER

The water temperature in the boiler remains constant at 85°C throughout the rinse, as the boiler refill only occurs once the rinse cycle is done.

RINSE PUMP

The water is sucked from the boiler through a rinse pump and is sent to the rinse nozzles. The correct pressure is ensured regardless of the water inlet pressure and temperature.





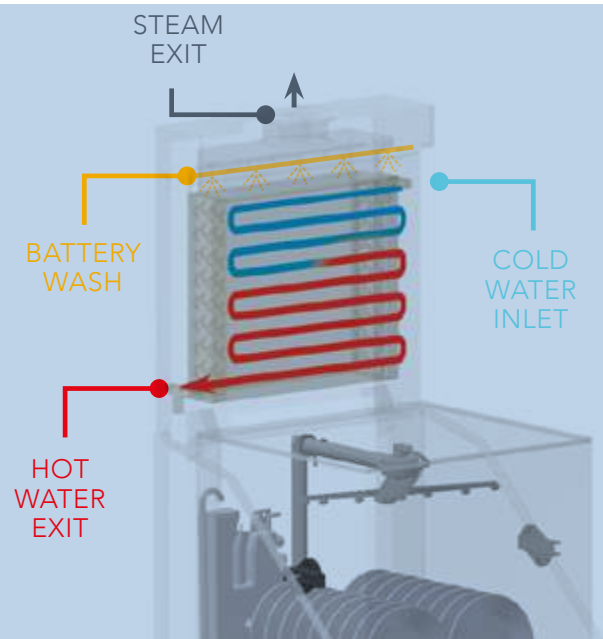



HR - ENERGY RECOVERY

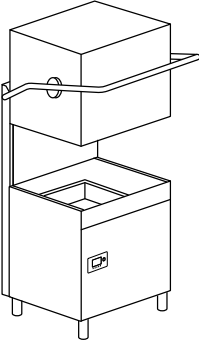



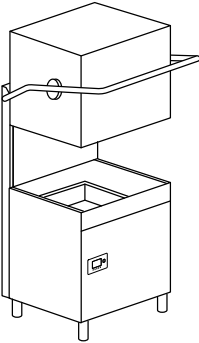



The ENERGY RECOVERY system uses the heat produced by the machine to preheat the inlet cold water (8-15 °C). This is an immediate saving on energy costs. Additionally, an optimal temperature in the dishwashing area is achieved as the air is no more affected by steam and humidity.

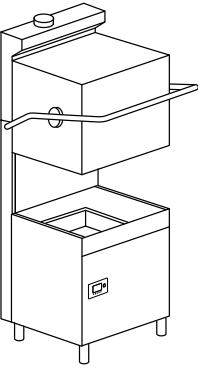

AQUAFORCE

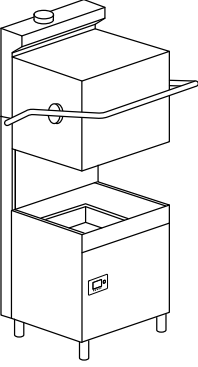
COMBI HIGH-PRESSURE WAREWASHER
FOR TRAYS AND PLATES

Model		Voltage	Capacity	Dimensions	Code
AQUAFORCE	ELECTRONIC 8 PROGRAMS				
		400 V 3N 50 Hz 13 kW	 4xGN 1/1 -----  2 trays 600x400  210 < Ø < 240 Useful height: 55 cm	830x940x 1720/2200 H	AQUAFORCE
AQUAFORCE LIFT	ELECTRONIC 8 PROGRAMS				
		400 V 3N 50 Hz 13 kW	 4xGN 1/1 -----  2 trays 600x400  210 < Ø < 240 Useful height: 55 cm	830x940x 1720/2200 H	AQUAFORCE LIFT

Model	Voltage	Capacity	Dimensions	Code
AQUAFORCE HR	ELECTRONIC 8 PROGRAMS			
	400 V 3N 50 Hz 13 kW	 4xGN 1/1 -----  2 trays 600x400  210 < Ø < 240 Useful height: 55 cm	830x940x 2277 H	AQUAFORCE HR
AQUAFORCE HR LIFT	ELECTRONIC 8 PROGRAMS			
	400 V 3N 50 Hz 13 kW	 4xGN 1/1 -----  2 trays 600x400  210 < Ø < 240 Useful height: 55 cm	830x940x 2277 H	AQUAFORCE HR LIFT

OPTIONS

				BT	DBE	DDE	PS
Model	380-415 V 3N 50 Hz	220-240 V 3 50 Hz	380-415 V 3 50 Hz	Break tank	Peristaltic rinse-aid disp.	Detergent dispenser	Drain pump
AQUAFORCE	●	□	€	●	●	€	€
AQUAFORCE HR	●	□	€	●	●	€	€
AQUAFORCE LIFT	●	□	€	●	●	€	€
AQUAFORCE HR LIFT	●	□	€	●	●	€	€

● Standard

---- Not available

□ Upon request

HR Available in case of osmotic water supply, if the electrical conductivity is higher than 200 microsiemens

LIFT Automatic hood lift at the end of the cycle

PLUS Rinse with constant temperature and stabilized consumption

EAC label upon request

Water supply 55° C. Water hardness min 2°f - max 8°f (if higher, an external water softener is required)

XP In case of cold water supply for rinse 8 °C 55 °C, and without any heat recovery, the extra power option is mandatory

	SA	VA	DVGW	XP	PAP	WRAS	CONTROL
Model	Automatized drain	Suction fan	DVGW	Extra power	Booster pump	WRAS	Substitute remote control panel
AQUAFORCE	€	€	€	€	●	€	€
AQUAFORCE HR	€	----	----	€	●	----	€
AQUAFORCE LIFT	€	€	€	€	●	€	€
AQUAFORCE HR LIFT	€	----	----	€	●	----	€

WRAS - DVGW Booster pump included.

BT Booster pump included.

With osmotic water supply and electrical conductivity lower than 200 microsiemens, it is mandatory to install a stainless steel heat exchanger

Water supply 55 °C. Water hardness min 2°f - max 8°f (if higher, an external water softener is required)

We recommend to install the machine in a well ventilated room, with a properly sized steam exhausting system

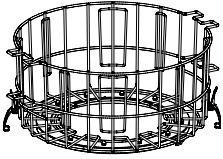
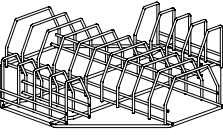
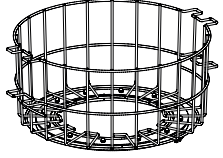
	Description	Capacity	Dimensions	Code	
	TRAYS BASKET	Standard 4 GN 1/1 or 2 600 x 400 mm trays	615x265H	11900028	
	SUPPORT FOR DISH BASKET	Standard 14 dishes	500x500x105H	11900029	
	DISH SUPPORT BASKET	Standard	615x265H	11900030	



Why waste your time with soak and prewash when there are plenty of more useful things to be done in the kitchen? Consider giving a value to wasted hours and the amount of water and detergent used to moisten encrusted pans. Plus the time and effort to scrub, wash and dry them! The conclusion is easily deduced; it's a waste of time, energy and resources. A waste of money. This is when the KROMO GRANULE Utensil Washers enter the scene. The

abrasive power of the projected GRANULE, mixed together with water and detergent, guarantee an excellent result in a few minutes wash. Even with the most tenaciously encrusted pans. A precious and necessary equipment designed to fulfil the needs of canteens, caterers, airports and restaurants' modern kitchens, giving the right value to time and money.



❄️ Encrusted pots and pans are often a problem. They require soaking and manual cleaning therefore a waste of time and resources only for this particular task.



❄️ The combined action of water, detergent and granules blasted at high pressure ensures considerable time and energy savings, as well as chemicals, water and electricity. All in favour of our environment.









❄️ Excellent results against the most stubborn dirt. Moreover, the speedy cycles allow a quick re-use of the kitchenware. The Staff that was previously employed to soak and hand wash, will now be free to perform other tasks.

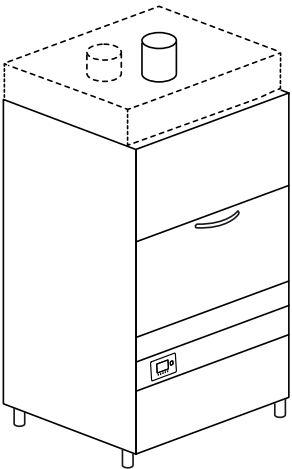

FEATURES

- The washing system is covered by an International Dual Patent
- Twelve wash cycles, six of which combine water detergent and granules
- Control panel with soft touch membrane keys
- Functional LCD Display for a constant control of all operations
- Multi language control panel
- Double-wall body, fully insulated with high performance thermo-acoustic material
- AISI 316 body and impeller, high performance wash-pump
- Wash-tank in AISI 304 S/S with guaranteed homogeneous thickness
- Double, vertical easy-fit wash-arms, with concave nozzles to prevent clogs and to optimize the combined flow of water and granules
- Electric and electronic components sheltered
- The round basket is placed on a rotating support stand, to optimise the mechanical action of the granules on the surfaces to wash
- Granules collection strainer, with right-level mark for granules
- The sturdy lower part of the door becomes a perfect working surface, simplifying the load/unload operations
- The optional service trolley facilitates the loading/unloading of the machine, increasing the operation speed and, consequently, the machine's productivity
- Heat recovery unit, to save energy resources and cut down the steam

Model	Voltage	Capacity	Dimensions	Code	
GR 300 PLUS 12 PROGRAMS					
	400 V 3N ~ 50 Hz 13 kW	6xGN 1/1 (cycle with GRANULE) 10xGN 1/1 (cycle without GRANULE)  530x325x65 H max or 3xGN 1/1 (cycle without GRANULE)  530x325x230 H max -----  x2: 650x530x140 H max or x1: 650x530x300 H max ----- 4XEN  600x400x20 H 600x400x50 H -----  Ø30 max 50 H Ø40 max 45 H Ø50 max 35 H	1095x910 1910/2020 H 303 kg	GR 300 PLUS	

OPTIONS

					XP	PS	DBE
Model	220-240 V 50 Hz	380-415 V 3N 50 Hz	220-240 V 3 50 Hz	380-415 V 3 50 Hz	Extra power	Drain pump	Peristaltic rinse-aid disp.
GR 300 PLUS	----	●	□	€	€	----	●
GR 300 HR PLUS	----	●	□	€	€	----	●
GR 800 HR PLUS	----	●	□	€	€	----	●

● Standard

---- Not available







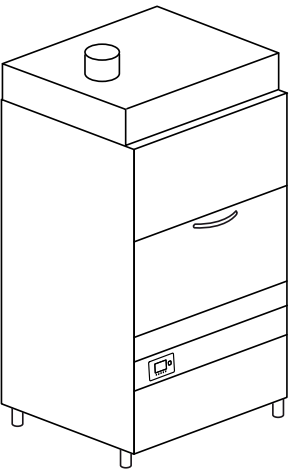

□ Upon request

XP In case of cold water supply for rinse 8 °C 55 °C, and without any heat recovery, the extra power option is mandatory.+ 3000 W with standard voltage only, for further voltage information, please contact us. In case of cold water supply for rinse 8-15 °C, is recommend the heat recovery option.

Water supply 55 °C (not on HR version). Water hardness min 2°f - max 8°f (if higher, an external water softener is required)

EAC label upon request

Option compatibility to be confirmed by the manufacturer after verification

Model	Voltage	Capacity	Dimensions	Code
GR 800 HR PLUS 12 PROGRAMS				
<i>PATENTED</i>				
	400 V 3N ~ 50 Hz 13 kW	 x8: 530x325xmax65 H or x4: 530x325xmax300 H -----	1200x1010 2260/2305 H 350 kg	GR 800 HR PLUS
		 x4: 650x530xmax65 H or x2: 650x530xmax250 H -----		
		3XEN  800x600x20 H  800x600x50 H -----		
		 Ø30 max 60 H  Ø40 max 60 H  Ø50 max 50 H		



	DDE	PAP	BT	WRAS	DVGW	FLOAT	DWI	PI
Model	Detergent dispenser	Booster pump	Break tank	WRAS	DVGW	Probes lack det. and rinse aid	Thermoacoustic insulation	S/S pumps
GR 300 PLUS	€	●	●	€	€	€	●	●
GR 300 HR PLUS	€	●	●	----	----	€	●	●
GR 800 HR PLUS	€	●	●	----	----	€	●	●

BT - WRAS - DVGW Booster pump included

DVGW Components prescribed by DVGW on request (check option compatibility with the manufacturer)

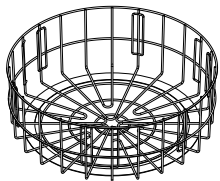
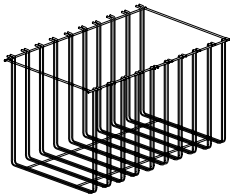
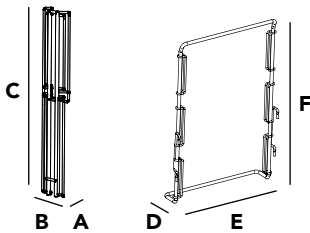
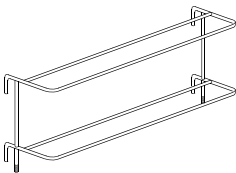
HR Heat recovery (in case of cold water supply 8-15 °C)
 The ENERGY RECOVERY system uses the heat produced by the machine to preheat the infeed of cold rinse water supply (8-15 °C)
 Optimal air temperature in the dishwashing area thanks to the reduction of the steam and the humidity produced by the machine
 Available in case of osmotic water supply, if the electrical conductivity is higher than 200 microsiemens

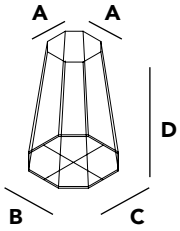
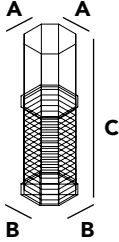
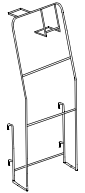
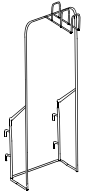
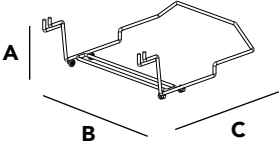
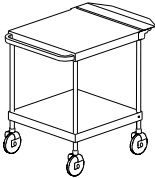
	Description	Capacity	Dimensions	Code	
	ROUND BASKET	Standard equipment for GR 300 PLUS 6 pz GN 1/1 o 2 pz GN 2/1	Ø735x300H	96101	
	STAND FOR TRAYS	Standard equipment for GR 300 PLUS 10 pz GN 1/1 GASTRONORM max 40 mm	655x345x285H	96135	
	STAND FOR TINS	Standard equipment for GR 300 PLUS 4 pz 600x400x20 H 4 pz 600x400x50 H EURONORM	430x100x195H	96136	
	ROUND BASKET	Standard equipment for GR 800 HR PLUS 8 pz GN 1/1 or 4 pz GN 2/1	Ø850x350 H	96601	
	SUPPORT	Standard equipment for GR 800 HR PLUS 4 pcs (96602) GN 1/1, 2/1 1 pcs (96604) GN 1/1, 2/3, 1/2, 1/3	A: 60 B: 120 C: 580 D: 80 E: 400 F: 550	96602 96604	
	STAND FOR TINS	Standard equipment for GR 800 HR PLUS 3 pz 800x600x20 H 3 pz 800x600x50 H EURONORM	500x80x365H 15 kg	96603	

	Description	Capacity	Dimensions	Code	
	SUPPORT	Standard equipment for GR 300 PLUS GR 800 HR PLUS Stand for 96103 and pots stand	A: 180 / 180 B: 350 C: 320 D: 260 H	96102	
	BASKET	Standard equipment for GR 300 PLUS GR 800 HR PLUS Spatulas basket	A: 190 / 190 B: 210 / 210 C: 410 H	96103	
	SUPPORT	Standard equipment for GR 300 PLUS GR 800 HR PLUS Stand for small pots and frying pans	260x180x570H	96104	
	SUPPORT	Standard equipment for GR 300 PLUS GR 800 HR PLUS Stand for big pots	260x160x535H	96105	
	BASKET LIFTER	Standard equipment for GR 300 PLUS GR 800 HR PLUS Trolley to easily lift the basket	A: 205 H B: 445 C: 550	96605	
	SERVICE TROLLEY	Option equipment for GR 300 PLUS GR 800 HR PLUS	600x600x900H 15 kg	TROLLEY	
	GRANULE	Standard equipment for GR 300 PLUS GR 800 HR PLUS Bucket 12 L	280x280x290H (9 kg)	96100	











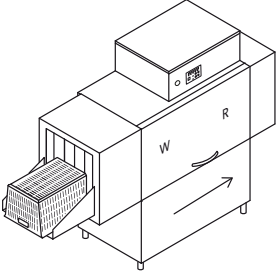

VK models are conceived to wash a large quantity of crates and containers of any kind. They represent the ideal solution for bakeries, pastries and for the general food industry, that require a continuous workload with cleaned container result. Thanks to the variety of available versions and possibility of personalized configurations, any kind of dirt can be removed efficiently. Several options are available, to provide the best fit into the wash area and minimize the need of efforts and labor. The VK line is design-

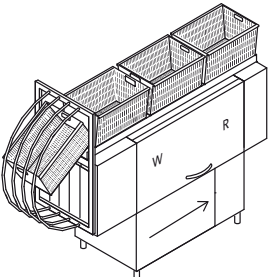
ned to provide, mainly in the bakery sector, stunning results at low running costs, allowing remarkable savings under each aspect of its usage. The range is composed of 9 models, all suitable for the general food-industry, to wash and sanitize a large number of crates every day. Versatility is one of the most prominent advantages of this line, combined with easy operations and absolute cleanliness, according to the strictest hygiene prescriptions.

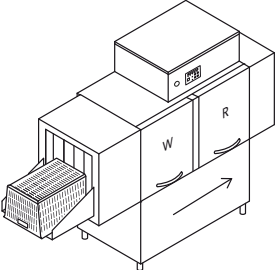

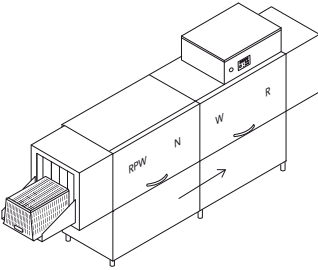
FEATURES

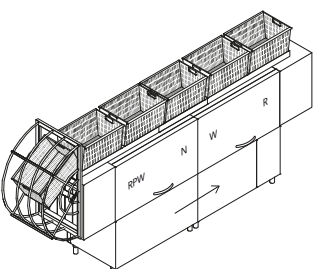
- Electrical or steam-heated VK 2310, VK 3010 and VK 4010
- Middle-rail system, perfect to wash crates of any width. In addition, our VK 2310 + KP23 , VK 3010 + KP23 and VK 4010 + KP23 models are equipped with an innovative top-down loading system allowing a "one-person-only" operation
- Five operating speeds
- Double-wall body in stainless steel AISI 304
- ACID PROOF radial wash tanks and fully insulated boilers in s/s AISI 316; minimize thermal loss
- Self-cleaning vertical wash pumps, protected from electrical overloads
- Double-skin doors with THERMO BARRIER device, insulated and counterbalanced, equipped with anti-fall safety device.
- CLEAN+ surface filters in stainless steel
- Easily removable wash and rinse arms in stainless steel
- S/S adjustable feet
- Inlet shelf and splash-guard modules at inlet and outlet
- Anti-contamination curtains
- Consumptions economizers
- Electronic panel with IPX5 membrane keyboard, ensuring a constant monitoring of operating parameters
- Autotimer, switching off the rack conveyor motor and all electrical devices after a pre-set inactivity
- Centralized drain 1-DRAIN for VK 2310, VK 2510 and VK 2810 models

Model	Voltage	Capacity	Dimensions	Code
VK 2310 5 SPEEDS				
	400 V 3N ~ 50 Hz 30 kW	 510x500 H	2600x805x1830/2120 H 270 kg	VK 2310
	400 V 3N ~ 50 Hz 2,4 kW 45 kg/h	1,55 - 2,0 m/min		VK 2310 V
VK 2310 + KP23 5 SPEEDS - Upper loading system				
	400 V 3N ~ 50 Hz 30 kW	 510x500 H 1,55 - 2,0 m/min	2710x805x2075/2120 H 280 kg	VK 2310 + KP23
VK 2810 5 SPEEDS				
	400 V 3N ~ 50 Hz 33 kW	 510x800 H 1,55 - 2,0 m/min	2800x805x2130/2720 H 310 kg	VK 2810
VK 3010 - VK 4010 5 SPEEDS				
	400 V 3N ~ 50 Hz 37 kW	 510x500 H	4100x805x1830/2120 H 455 kg	VK 301 37 kW0
	400 V 3N ~ 50 Hz 41 kW	1,75 - 2,65 m/min (VK 3010)		VK 3010 V 54 kgv/h 3,65 kW
		2,65 - 4,0 m/min (VK 4010)		VK 4010 41 kW0
				VK 4010 V 59 kgv/h 4,6 kW
VK 3010 + KP23 - VK 4010 + KP23 5 SPEEDS - Upper loading system				
	400 V 3N ~ 50 Hz 37 kW	 510x500 H	4210x805x2075/2120 H 505 kg	VK 3010 + KP23
	400 V 3N ~ 50 Hz 41 kW 40,58 kg/h	1,75 - 2,65 m/min (VK 301 SPECIAL0) 2,65 - 4,0 m/min (VK 401 SPECIAL0)		VK 4010 + KP23

Model	Voltage	Capacity	Dimensions	Code
VK 2510 5 SPEEDS - For non-perforated crates	400 V 3N ~ 50 Hz 29,4 kW	510x500 H 1,55 - 2,0 m/min	3200x805x1830/2120 H 370 kg	VK 2510
VK 3510 5 SPEEDS - For non-perforated crates	400 V 3N ~ 50 Hz 36,65 kW	510x500 H 1,75 - 2,65 m/min (VK 3510)	4700x805x1830/2120 H 555 kg	VK 3510

- W** Wash
- R** Single rinse
- N** Neutral zone
- RPW** Reinforced prewash
- V** Steam-heated

EAC label upon request

Option compatibility to be confirmed by the manufacturer after verification

	H max	min < L1 < max	min < L2 < max	Depth max
VK 2310 - VK 3010 - VK 4010	500	400 < L1 < 510	400* < L2 < 510	600
VK 3010 - VK 4010 + DRYER	500	400 < L1 < 510	400* < L2 < 510	600
VK 2810	800	400 < L1 < 510	400* < L2 < 510	600
VK 2310 + KP23 - VK 3010 + KP23 - VK 4010 + KP23	500	400 < L1 < 470	400* < L2 < 510	600
VK 2510 - VK 3510	500	400 < L1 < 510	400* < L2 < 510	600

*Verify with the manufacturer

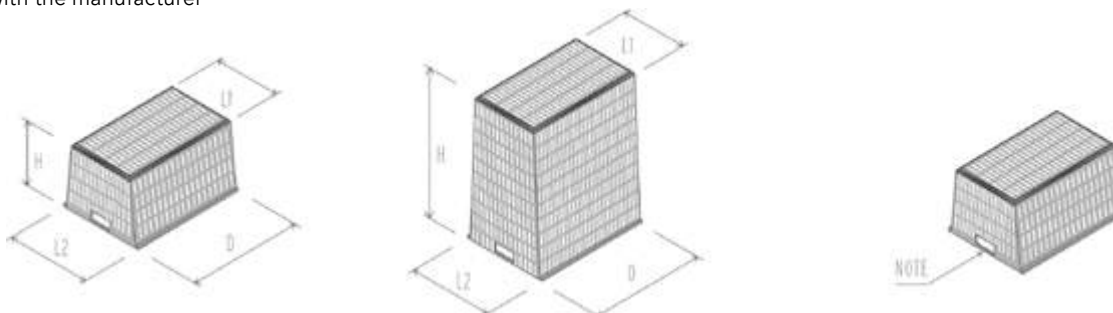

NOTE: Should you need to wash baskets with non-standard handles or dimensions, please contact our technical department

OPTIONS

			XP	DDE-GROUP	PI	DRIVE	AUTOTIMER
Model	220-240 V 3 50 Hz	60 Hz	Extra power	Dispensers kit	S/S pumps	Smart drive	Autotimer
VK 2310	€	+ 3%	€	€	€	€	●
VK 2310 V	€	+ 3%	----	€	€	€€	●
VK 2310 + KP23	€	+ 3%	€	€	€	€€	●
VK 2810	€	+ 3%	€	€	€	€€	●
VK 3010	€	+ 3%	€	€	€	€€	●
VK 3010 V	€	+ 3%	----	€	€	€€	●
VK 3010 + KP23	€	+ 3%	€	€	€	€€	●
VK 4010	€	+ 3%	€	€	€	€€	●
VK 4010 V	€	+ 3%	----	€	€	€€	●
VK 4010 + KP23	€	+ 3%	€	€	€	€€	●
VK 2510	€	+ 3%	€	€	€	€€	●
VK 3510	€	+ 3%	€	€	€	€€	●

● Standard

---- Not available

DDE-GROUP Both detergent (with probe) and rinse-aid dispensers included

PI Available with 50 Hz frequency only

DRIVE Check voltage compatibility

Water supply 55 °C. Water hardness min 2°f - max 8°f (if higher, an external water softener is required)

We recommend to install the machine in a well ventilated room, with a properly sized steam exhausting system

Option compatibility to be confirmed by the manufacturer after verification

	DOS/S	PAP	DIV	1-DRAIN	DWI	BT	DVGW
Model	Dispenser with probe	Booster pump	Price for division	Centralized drain	Thermoacoustic insulation	Break tank	DVGW
VK 2310	€	€	€	●	€	€	€
VK 2310 V	€	€	€	●	€	€	€
VK 2310 + KP23	€	€	€	●	€	€	€
VK 2810	€	€	€	●	€	€	€
VK 3010	€	€	€	€	€	€	€
VK 3010 V	€	€	€	€	€	€	€
VK 3010 + KP23	€	€	€	€	€	€	€
VK 4010	€	€	€	€	€	€	€
VK 4010 V	€	€	€	€	€	€	€
VK 4010 + KP23	€	€	€	€	€	€	€
VK 2510	€	€	€	●	€	€	€
VK 3510	€	€	€	€	€	€	€

DOS/S Only for detergent dispenser

DWI Insulation option for the tunnel only, dryer excluded. Recommended with KHR10 – KHR20 – KHRP40

BT Booster pump included

DVGW Not available with heat recovery and steam condenser
Components prescribed by DVGW on request (check option compatibility with the manufacturer)

+ KP23 Upper sliding support for crates with maximum width 475 mm

OPTIONS

	KDR94	KDR99	KDR9V	KTB94	KTB99	KTB9V
Model	Dryer + 700 mm / 4,5 kW	Dryer + 700 mm / 9 kW	Steam dryer + 700 mm	Dryer on module with blowers	Dryer on module with blowers	Steam dryer on module with blowers
VK 2310	€	€	----	€	€	----
VK 2310 V	----	----	€	----	----	€
VK 2310 + KP23	----	----	----	----	----	----
VK 2810	----	----	----	----	----	----
VK 3010	€	€	----	€	€	----
VK 3010 V	----	----	€	----	----	€
VK 3010 + KP23	----	----	----	----	----	----
VK 4010	€	€	----	€	€	----
VK 4010 V	----	----	€	----	----	€
VK 4010 + KP23	----	----	----	----	----	----
VK 2510	€	€	----	€	€	----
VK 3510	€	€	----	€	€	----

- Standard
- Not available

ALL DRYERS Ask the producer for effectiveness on drying results according to the basket to wash. The insulation of the dryers is not available

KDR94 With VK 3010, VK 4010, VK 3510, optional not ideal, verify with manufacturer

With osmotic water supply and electrical conductivity lower than 200 microsiemens, it is mandatory to install a stainless steel heat exchanger

Option compatibility to be confirmed by the manufacturer after verification

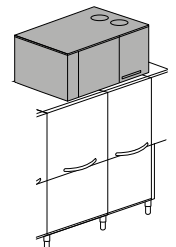
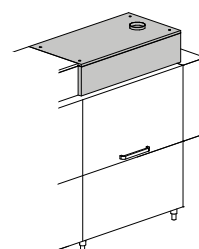
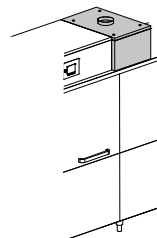
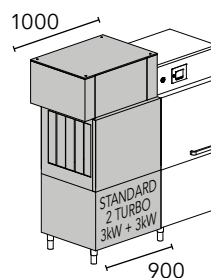
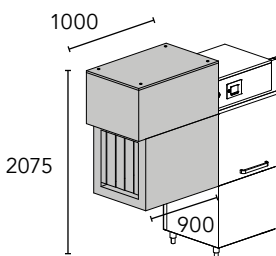

KDR94 4,5 kW

KDR99 9 kW

Dryer

KDR9V

Steam heated dryer

KT B94 11,6 kW

KT B99 16,1 kW

Dryer on module with
blowers

KT B9V 7,1 Kw

Steam heated dryer on
module with blowers

KSC10

Steam condenser

KHR10

Compact heat
recovery

KHR20

heat recovery

KHRP40

Heat recovery
with heat pump

	KDR54	KDR59	KSC10	KHR10	KHR20	KHRP40
Model	Dryer 4,5 kW	Dryer 9 kW	Steam condenser	Heat recovery	Heat recovery	Heat recovery
VK 2310	----	----	€	€	----	----
VK 2310 V	----	----	€	€	----	----
VK 2310 + KP23	----	----	----	----	----	----
VK 2810	€	€	€	€	----	----
VK 3010	----	----	€	€	€	€
VK 3010 V	----	----	€	€	€	€
VK 3010 + KP23	----	----	----	----	----	----
VK 4010	----	----	€	€	€	€
VK 4010 V	----	----	€	€	€	€
VK 4010 + KP23	----	----	----	----	----	----
VK 2510	----	----	€	€	----	----
VK 3510	----	----	€	€	€	€

**KHR10 - KHR20 -
KHRP40**

In case of cold water supply for rinse (8-15 °C), we recommend to install the heat recovery system optional.

XP

In case of cold water supply for rinse 8 °C 55 °C, and without any heat recovery, the extra power option is mandatory. In case of cold water supply for rinse 8 °C 55 °C, we recommend the heat recovery as option.

We strongly recommend the presence of a roller table with end microswitch at the exit of our rack conveyor machines for a correct operation.

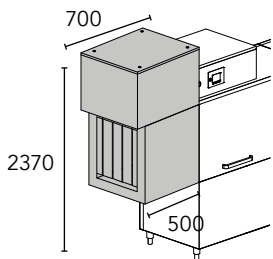

KDR54 4,5 kW

KDR59 9 kW

Dryer

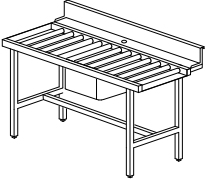
	Description	Capacity	Dimensions	Code	
	TABLE + SINK	Sink 500x400x270 H	1200x730x860 H	K 55	
	TABLE + SINK	Sink 500x400x270 H Standard rubber ring	1500x730x860 H 1800x730x860 H	K 8 K 9	
	ROLLER TABLE + sink, right or left version	Sink 500x400x270 H	1600x730x860 H	K 195	
	LINEAR ROLLER TABLE WITH TANK	Option end microswitch	1100x650x860 H 1600x650x860 H 2100x650x860 H	K 19 * K 19/B * K 19/C * K 18	

* Wooden cage +2% minimum + €

Special dimensions for tables upon request

Tables shown in right-to-left version

We strongly recommend the presence of a roller table with end microswitch at the exit of our pull-through create washers for a correct operation



KROMO conveyor crate-washers are the perfect answer for all those sectors in the food industry dealing with heavy workloads on a daily basis: large bakeries and pastry shops, meat or fish industry, catering services, commercial kitchens, airport facilities. Our LK and HD lines have been designed to offer our clients a comprehensive solution, tailored to their needs and work habits. Our conveyor crate-washers line offers the possibility to choose among six highly customizable models, which with features such as the usable belt width of 640 mm, usable

height of 450 mm and a constant monitoring of operation temperatures and wash results, that guarantees to maintain the distinctive part of KROMO brand for long life. All this while preserving limited dimensions, lower than the market average at an equal production capacity: with LK and LK HD machines it is possible to wash even big or non-standard baskets, thanks to the addition of dedicated neutral zones between modules. Optimal wash results are always KROMO's main goal. What else to say, other than just try our LK and HD models?



FEATURES

STANDARD

- SMART DRIVE 5 speeds advancement system
- 710 mm wide conveyor with usable width of 640 mm
- Standard crates belt
- TFT 5.7" display and soft touch keyboard
- Frequently used keys shortcut and menu language setting
- Constant monitoring of key operations
- IPX5 electronic board
- Alarms and events report
- Autotimer
- Centralized 1-DRAIN and automatic AD drain, with total or partial emptying of the tanks
- Independent and adjustable wash arms
- Use economizers
- ECO-DET Detergent economizer
- ACID PROOF Radial wash tanks in AISI 316 stainless steel inclined to provide complete drainage of the wash water
- ACID PROOF stainless steel boilers in AISI 316, fully insulated to reduce thermal loss
- S/S surface filters CLEAN+ to protect the wash tanks as well as the wash pump
- Double-skin, insulated and counterbalanced doors, equipped with anti drop safety system
- THERMO BARRIER system for comfort in use
- Predisposition for KROMO rinse-aid and detergent dispensers connection
- Vertical self-cleaning pumps
- Reinforced double rinse 2R+, improved efficiency with lower consumption
- CPF System: Controlled Pressure Flow
- Water, energy consumptions and working time control system
- Possible working modes for dryer unit: all off, only fan, half power 4,5 kW + fan, total power 9 kW + fan
- Peak-cut for dosing included
- Estimated consumption readout

THERMO BARRIER

Our state of the art doors offer three main advantages: improved insulation of the washing chamber to maintain a constant temperature, reduction of power consumptions for boiler heating elements, and a decrease of humid vapour dispersed in the environment.

ACID PROOF

Our machines benefit from maximum protection against aggressive cleaning agents and salty water, thanks to the special composition and quality of the steel used for construction, both outdoing market standards. AISI 316 steel is indeed mainly employed in specific conditions of temperature and chemicals concentrations.

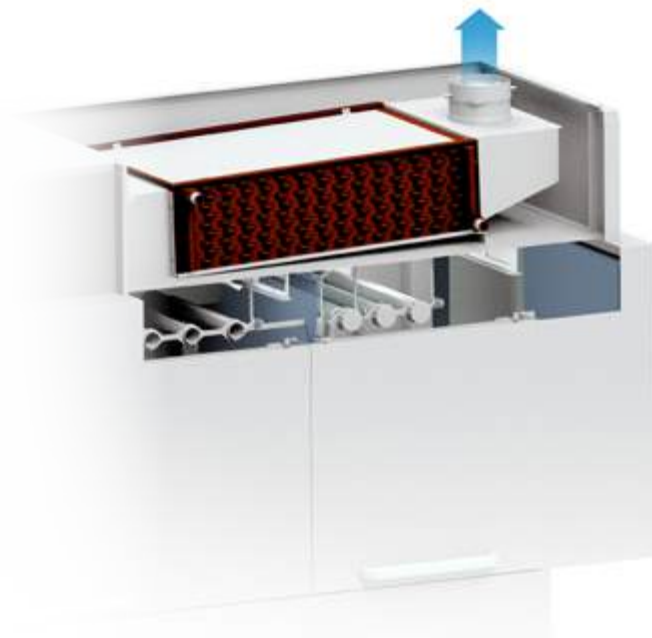

CLEAN+

The tank filtration system by KROMO ensures three protection modules: the first removing persistent dirt, the second on the overall tank to prevent water contamination and a third filter system to protect components.

CPF

This simple device allows for easy adjustment of water pressure in the prewash or wash phase according to one's needs. By pulling the dedicated leve, it is possible to decrease the water flow through the nozzles of upper/lower wash arms.

OPTIONS

- Double belt or lower belt conveyor available
- Double skin shelf or dryer module
- Steam condenser
- 3 models of heat recovery to be chosen
- Dispensers kit with peristaltic pump, for detergent as well as rinse-aid
- Delivery in 2 or more parts, to ease installation operations
- Automatic self-cleaning of the machine available, with dedicated booster pump on request
- Thermal and acoustic insulation
- Tank insulation
- Heavy duty belt
- Break tank and booster pump
- Dedicated space for detergent and rinse-aid jugs
- S/S pumps
- Extra power in the boiler
- CONNECTIVITY remote control compliant with the HACCP norms

CONNECTIVITY 4.0 & APP

WHEREVER YOU ARE...

YOUR DISHWASHER, JUST A CLICK AWAY

You will be constantly connected to the machine to monitor the work phases, review any eventual alarm and configure remotely the operating parameters according to your needs. Compliant with HACCP norms. Thanks to our brand new App, you will have access to connected machines and all commercial and technical documentation.

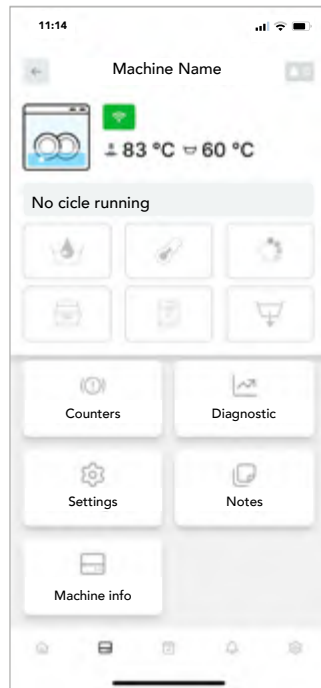

View all the working parameters and event records, working hours and any problem at any time.











In case of problem, the machine promptly alerts you. The technician can intervene remotely to solve the problem or anticipate the needed parts for an on-site intervention.

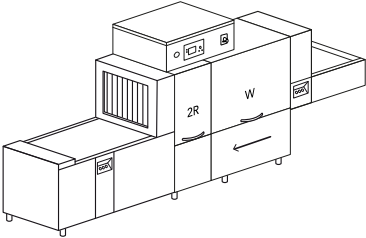

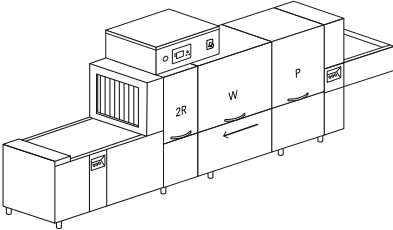

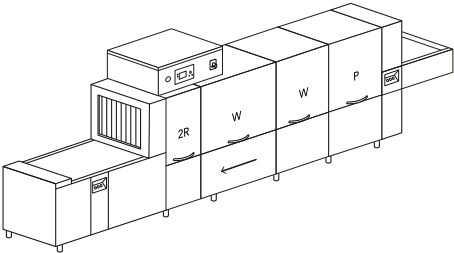

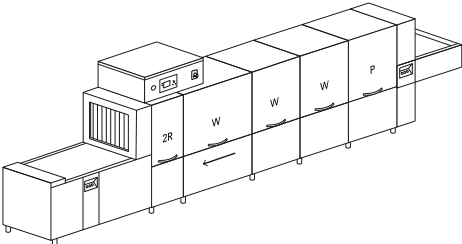
A daily activity report is available with all the events related to the dishwasher in a detailed spreadsheet with HACCP data.

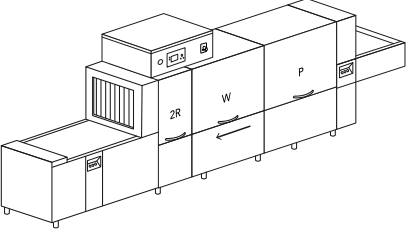

Our Connectivity system is a revolutionary device limiting and facilitating the eventual intervention of a technician who can anticipate the necessary parts to be replaced, saving time and money.

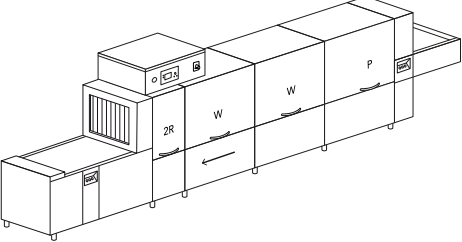
Model	Voltage	Capacity	Dimensions	Code
LK 5010 5 SPEEDS				
	400 V 3N ~ 50 Hz 31,5 kW	 640x450 H belt width 710	4900x985x1860/2200 H 625 kg	LK 5010
	400 V 3N ~ 50 Hz 2,5 kW 48 kg/h	usable width 640 2,20-3,45 m/min		LK 5010 V
LK 7510 5 SPEEDS				
	400 V 3N ~ 50 Hz 36,5 kW	 640x450 H belt width 710	5800x985x1860/2200 H 775 kg	LK 7510
	400 V 3N ~ 50 Hz 4,5 kW 52 kg/h	usable width 640 3,25-5,10 m/min		LK 7510 V
LK 10010 5 SPEEDS				
	400 V 3N ~ 50 Hz 56,5 kW	 640x450 H belt width 710	6700x985x1860/2200 H 925 kg	LK 10010
	400 V 3N ~ 50 Hz 6,5 kW 82 kg/h	usable width 640 4,45-6,95 m/min		LK 10010 V
LK 12510 5 SPEEDS				
	400 V 3N ~ 50 Hz 74,5 kW	 640x450 H belt width 710	7600x985x1860/2200 H 1075 kg	LK 12510
	400 V 3N ~ 50 Hz 8,5 kW 108 kg/h	usable width 640 5,27-8,23 m/min		LK 12510 V

Model	Voltage	Capacity	Dimensions	Code
LK 8510 HD 5 SPEEDS				
	400 V 3N ~ 50 Hz 34,92 kW	 640x450 H belt width 710	6200x985x1860/2200 H 790 kg	LK 8510 HD
	400 V 3N ~ 50 Hz 4,42 kW 50 kg/h	usable width 640 1,4-2,15 m/min		LK 8510 HD V
LK 11010 HD 5 SPEEDS				
	400 V 3N ~ 50 Hz 52,42 kW	 640x450 H belt width 710	7500x985x1860/2200 H 1050 kg	LK 11010 HD
	400 V 3N ~ 50 Hz 6,42 kW 76 kg/h	usable width 640 1,95-3 m/min		LK 11010 HD V

- P** Prewash
- W** Power wash
- 2R** Pre-rinse + rinse on module
- V** Steam supply

Option compatibility to be confirmed by the manufacturer after verification

OPTIONS

Model	220-240 V 3 50 Hz	380-415 V 3N 50 Hz	60 Hz	PRE DOS KROMO disp. connections	DDE-GROUP Dispensers kit	DOS/S Dispenser with probe	SAN Sanitization system	PAP-SAN Booster pump sanitiz.	DWI Thermo- acoustic insulation	AUTOTIMER
LK 5010	+ 2%	●	+ 3%	●	€	€	€	€	€	●
LK 5010 V	+ 1%	●	+ 3%	●	€	€	€	€	€	●
LK 7510	+ 2%	●	+ 3%	●	€	€	€	€	€	●
LK 7510 V	+ 1%	●	+ 3%	●	€	€	€	€	€	●
LK 10010	+ 2%	●	+ 3%	●	€	€	€	●	€	●
LK 10010 V	+ 1%	●	+ 3%	●	€	€	€	●	€	●
LK 12510	+ 2%	●	+ 3%	●	€	€	€	●	€	●
LK 12510 V	+ 1%	●	+ 3%	●	€	€	€	●	€	●
LK 8510 HD	+ 2%	●	+ 3%	●	€	€	€	€	€	●
LK 8510 HD V	+ 1%	●	+ 3%	●	€	€	€	€	€	●
LK 11010 HD	+ 2%	●	+ 3%	●	€	€	€	●	€	●
LK 11010 HD V	+ 1%	●	+ 3%	●	€	€	€	●	€	●

- Standard
- Upon request
- DDE-GROUP** Both detergent (with probe) and rinse-aid dispensers included
- PAP-SAN** Standard pump for models LK 10010, LK 12510, LK 11010 HD
- DIV** Compulsory for machines > 4,5 m
- BT** Booster pump included
- CONNECTIVITY** Includes HACCP option. 10 year plan
- DWI** Insulation option for the tunnel only, dryer excluded. Shelf dryer can be double skin upon request
- DWI-DWI/T** Recommended for KHRF10 - KHRF20 - KHRPF40
- XP** In case of cold water supply for rinse 8 °C 55 °C, and without any heat recovery, the extra power option is mandatory
In case of cold water supply for rinse (8-15 °C), we recommend to install the heat recovery system as optional.

Water supply 55 °C. Water hardness min 2°f - max 8°f (if higher, an external water softener is required)

EAC label upon request

Option compatibility to be confirmed by the manufacturer after verification

	DWI / T	CONNECTIVITY	XP	PAP	DRIVE	PI	1-DRAIN	ECO-DET	X-BELT	DIV	BT
Model	Tank insulation	Connectivity (HACCP)	Extra power	Booster pump	Smart drive	S/S pumps	Centralized drain	Detergent economizer	Special belt	Price for division	Break tank
LK 5010	€	€	€	€	●	€	●	●	+ 7%	€	€
LK 5010 V	€	€	□	€	●	€	●	●	+ 7%	€	€
LK 7510	€	€	€	€	●	€	●	●	+ 7%	€	€
LK 7510 V	€	€	€	€	●	€	●	●	+ 7%	€	€
LK 10010	€	€	€	€	●	€	●	●	+ 7%	€	€
LK 10010 V	€	€	€	€	●	€	●	●	+ 7%	€	€
LK 12510		€	€	€	●	€	●	●	+ 7%	€	€
LK 12510 V	€	€	□	€	●	€	●	●	+ 7%	€	€
LK 8510 HD	€	€	€	€	●	€	●	●	+ 7%	€	€
LK 8510 HD V	€	€	€	€	●	€	●	●	+ 7%	€	€
LK 11010 HD	€	€	€	€	●	€	●	●	+ 7%	€	€
LK 11010 HD V	€	€	€	€	●	€	●	●	+ 7%	€	€

OPTIONS

Model	NZ3 Neutral zone 300	NZ6 Neutral zone 600	NZH6 Neutral zone for dryer 600	KDRF69 Shelf dryer	KDRF6V Steam-heated shelf dryer	ID Double skin for shelf dryer	KDRF70 Shelf dryer	KDRF7V Steam-heated shelf dryer	KDRF99M Module dryer	KDRF99VM Steam heated dryer module	KDRF99MB Dryer on module with blowers	KDRF99MB1 Dryer on module with blowers
LK 5010	€	€	€	€	----	€	€	----	€	----	€	€
LK 5010 V	€	€	€	€	€	€	€	€	€	€	€	€
LK 7510	€	€	€	€	----	€	€	----	€	----	€	€
LK 7510 V	€	€	€	€	€	€	€	€	€	€	€	€
LK 10010	€	€	€	€	----	€	€	----	€	----	€	€
LK 10010 V	€	€	€	€	€	€	€	€	€	€	€	€
LK 12510	€	€	€	€	----	€	€	----	€	----	€	€
LK 12510 V	€	€	€	€	€	€	€	€	€	€	€	€
LK 8510 HD	€	€	€	€	----	€	€	----	€	----	€	€
LK 8510 HD V	€	€	€	€	€	€	€	€	€	€	€	€
LK 11010 HD	€	€	€	€	----	€	€	----	€	----	€	€
LK 11010 HD V	€	€	€	€	€	€	€	€	€	€	€	€

---- Not available

NZ3 Recommended to wash long baskets

NZ6 Recommended for big quantities of trays to wash. Module equipped with a front door

NZH6 Recommended with dryers with blowers

U-AIR Proximity air nozzles available on every dryer module

ID Recommended option for KDRF69 - KDRF6V. Only for dryer on shelf

HD+BELT For each dryer module and neutral zone, the extra price is + €

With osmotic water supply and electrical conductivity lower than 200 microsiemens, it is mandatory to install a stainless steel heat exchanger

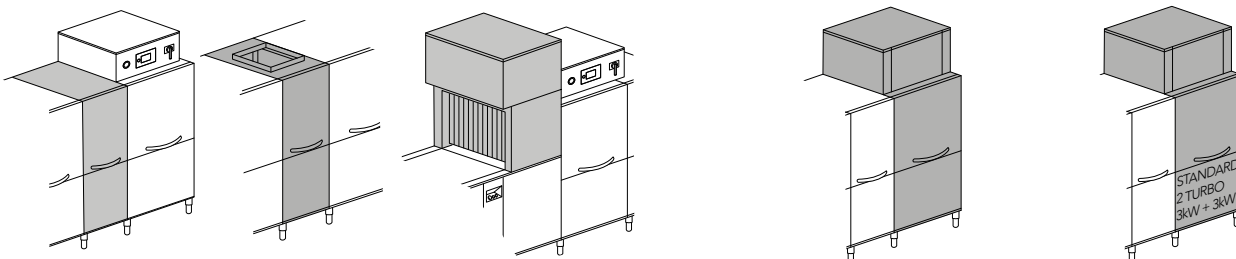

NZ3 + 300 mm
Neutral zone

NZH6 + 600 mm
Neutral zone with door for dryer

KDRF69 9 kW
Shelf dryer

KDRF6V
Steam heated shelf dryer
KDRF70
Double skin lateral shelf dryer with upper fan

KDRF7V
Steam-heated double skin shelf lateral dryer with upper fan

KDRF99M + 900 mm - 9 kW
Dryer module

KDRF99VM + 900 mm
Steam heated dryer module

KDRF99MB + 900 mm 16,1 kW
Dryer module

KDRF99MB1 + 900 mm 7,1 kW
Steam heated dryer module

	KDRF99MB2	KDRF9VMB	KDRF9VMB1	KDRF9VMB2	U-AIR	KSCF10	KHRF10	KHRF20	KHRPF40	3R	STOCK	HD+BELT
Model	Dryer on module with blowers	Steam dryer on module with blowers	Steam dryer on module with blowers	Steam dryer on module with blowers	Proximity air nozzle	Steam condenser	Heat recovery	Heat recovery	Heat recovery	Triple rinse	Chemicals compartment	Heavy-duty belt
LK 5010	€	----	----	----	€	€	€	----	€	€	€	€
LK 5010 V	€	€	€	€	€	€	€	----	€	€	€	€
LK 7510	€	----	----	----	€	€	€	€	€	€	€	€
LK 7510 V	€	€	€	€	€	€	€	€	€	€	€	€
LK 10010	€	----	----	----	€	€	€	€	€	€	€	€
LK 10010 V	€	€	€	€	€	€	€	€	€	€	€	€
LK 12510	€	----	----	----	€	€	€	€	€	€	€	€
LK 12510 V	€	€	€	€	€	€	€	€	€	€	€	€
LK 8510 HD	€	----	----	----	€	€	€	€	€	€	€	€
LK 8510 HDV	€	€	€	€	€	€	€	€	€	€	€	€
LK 11010 HD	€	----	----	----	€	€	€	€	€	€	€	€
LK 11010HDV	€	€	€	€	€	€	€	€	€	€	€	€

KDRF99MB1 - KDRF9VMB1 Lower by-pass belt with blowers. Maximum 1 per machine as an alternative to the double belt

KDRF99MB2 - KDRF9VMB2 Double belt with blowers. Maximum 1 per machine as an alternative to the lowered by-pass belt

KHRF10 - KHRF20 - KHRPF40 In case of cold water supply for rinse (8-15 °C), we recommend to install the heat recovery system optional.

Option compatibility to be confirmed by the manufacturer after verification

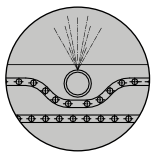

with blowers and lowered belt

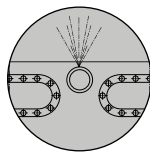

with blowers and double belt

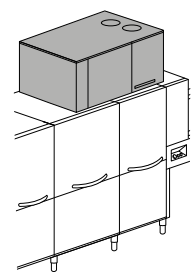
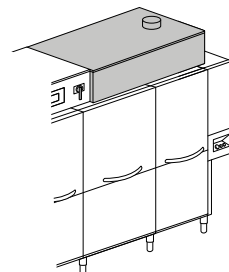
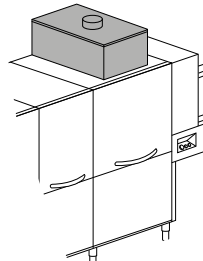
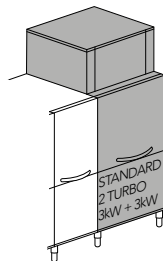
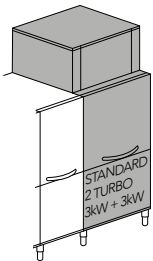

KDRF99MB1 + 900 mm 16,1 kW
Dryer module

KDRF99MB2 + 900 mm 16,1 kW
Dryer module

KHRF10
Compact heat recovery

KHRF20
heat recovery

KHRPF40
Heat recovery with heat pump

KDRF9VMB1 + 900 mm 7,1 kW
Steam heated dryer module

KDRF9VMB2 + 900 mm 7,1 kW
Steam heated dryer module

KSCF10
Steam condenser

OPTIONS

	MI900	MI1200	MIS1200	MI1500	MI1800	MI2200	MI2700
Model	Entry mod. 900	Entry mod. 1200	Over. entry mod. 1200	Entry mod. 1500	Entry mod. 1800	Entry mod. 2200	Entry mod. 2700
LK 5010	€	€	●	€	€	€	€
LK 5010 V	€	€	●	€	€	€	€
LK 7510	€	€	●	€	€	€	€
LK 7510 V	€	€	●	€	€	€	€
LK 10010	€	€	●	€	€	€	€
LK 10010 V	€	€	●	€	€	€	€
LK 12510	€	€	●	€	€	€	€
LK 12510 V	€	€	●	€	€	€	€
LK 8510 HD	€	€	●	€	€	€	€
LK 8510 HD V	€	€	●	€	€	€	€
LK 11010 HD	€	€	●	€	€	€	€
LK 11010 HD V	€	€	●	€	€	€	€

- Standard
- Upon request
- Not available

Option compatibility to be confirmed by the manufacturer after verification

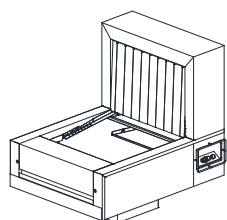

Overhanging entry module

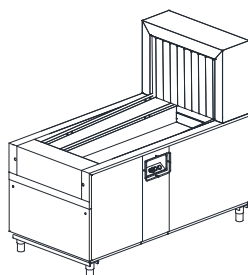

Entry module

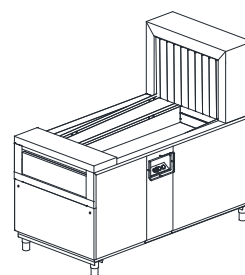

Exit module

	MIR2200	MIR2700	EM900	EM1200	EM1500	EM1800	EM2200	EM2700
Model	Lowered belt entry mod. 2200	Lowered belt entry mod. 2700	Exit mod. 900	Exit mod. 1200	Exit mod. 1500	Exit mod. 1800	Exit mod. 2200	Exit mod. 2700
LK 5010	€	€	□	□	□	●	€	€
LK 5010 V	€	€	□	□	□	●	€	€
LK 7510	€	€	□	□	□	●	€	€
LK 7510 V	€	€	□	□	□	●	€	€
LK 10010	€	€	□	□	□	●	€	€
LK 10010 V	€	€	□	□	□	●	€	€
LK 12510	€	€	□	□	□	●	€	€
LK 12510 V	€	€	□	□	□	●	€	€
LK 8510 HD	€	€	□	□	□	●	€	€
LK 8510 HD V	€	€	□	□	□	●	€	€
LK 11010 HD	€	€	□	□	□	●	€	€
LK 11010 HD V	€	€	□	□	□	●	€	€

BASKETS INCLUDED

GLASSWASHERS	2 x glass baskets, 1 x saucer holder, 1 x cutlery holders
DISHWASHERS	1 x dish basket, 1 x glass basket, 1 x cutlery holder (LUX 85 EL + 1 C43)
HOOD-TYPE DISHWASHERS	2 x dish baskets, 1 x glass basket, 2 x cutlery holders
MAXXI HOOD-TYPE DISHWASHERS	1 x dish basket, 1 large mesh basket, 1 trays basket, 2 x cutlery holders
RACK-TYPE DISHWASHERS	1 x dish basket, 1 x glass basket, 1 x cutlery basket (8 places), 1 x tray basket
WAREWASHERS	<p>KP 76 EL: 1 x S/S trays support, 1 x large mesh plastic basket, 1 x spatula holder (KP 76 EL + 1 S/S griddle)</p> <p>KP 86 EL PLUS: 1 x S/S griddles basket holder, 1 x S/S basket, 1 x trays support, 1 x S/S spatula holder</p> <p>KP MAXXI PLUS: 1 x dish basket, 1 large mesh basket, 1 trays basket, 1 x S/S spatula holder</p> <p>KP 151 EL - KP 152 EL PLUS: 1 x S/S basket, 1 x S/S griddle, 1 x trays support, 1 x S/S spatula holder</p> <p>KP 202 EL PLUS - KP 302 EL PLUS - KP 402 EL PLUS: 1 x S/S basket, 1 x S/S trays support, 1 x S/S spatula holder</p>

DELIVERY	20 days for semi-automatic machines - 50 days for automatic machine
PACKING	Cardboard box (included in the price). The wooden cage's price is the equivalent of the 2% of the machine's net price -minimum amount charged is €(on the following models: RK, QK, TK, TL, VK ,LK , LK-HD,K 7A, KM7, KM 22 , KM 23, K19, K21, K22, K23, K 5/20).
SPARE PARTS	For orders lower than € net, a € , fee will be applied as management costs.
TERMS	Ex-works (Castelfranco Veneto).
WARRANTY ON OUR PARTS	24 months from invoice date, subject to our Service verification of the problem causes.
TRANSPORT	The supply is carried out Ex works KROMO ALI GROUP Srl , Contracts stipulated with KROMO DIHR ALI GROUP Srl. The goods travel at the purchaser's sole risk even when the carrier has been chosen and instructed by KROMO ALI GROUP Srl on behalf of the purchasing party.
OWNERSHIP RESERVATION	The goods are the exclusive property of KROMO ALI GROUP Srl until the invoice is paid in full.
COURT OF JURISDICTION	Contracts stipulated with KROMOALI GROUP Srl are subject to Italian law. For any dispute that may arise from contracts with KROMO ALI GROUP Srl- including abroad contracts - the court of jurisdiction shall be that of Treviso.
USER MANUALS	User manuals are originally issued in a main EU language. When a machine is put into service, it must be provided with an appropriate translation of the original manual in the language(s) used in the country where the appliance is installed, along with its original instructions. This translation into the language or languages of the country of use, must be carried out at the care and responsibility of the person introducing the machine into the relevant linguistic area. In case of tunnel machines, any costs for the supervision of our technician during the installation and on-site testing phases will be quoted separately.

Ensure adequate ventilation of the room according to the legislation in force in the country of installation and the relevant technical standards. For example, for European countries, please refer to the EN 16282-1 standard.

Continual improvements may supersede specifications.

SERVICE PORTAL

Dear Customer,

we are pleased to inform you that our web portal is available online for spare part orders as well as to surf online documents related to your KROMO dishwashers.

- Contact our After Sales office to request login and password.
- Go to: <https://spares.kromo-ali.com>
- Login with your login and password data.

In this portal you can:

- Search for spare parts according to the serial number of the machines (possible consultation for machines produced since 2010)
- Search for parts (if you know the spare part code)
- Send information requests to our After Sales office

You can also upload an Excel file with the list of parts you wish to order.

In addition, on the portal you can find the documentation relating to your dishwashers by typing in the serial number: installation and user manuals, exploded view, CE certificate...There is a part dedicated to FAQs, the most common alarms and video tutorials for the maintenance and assistance of your dishwashers. This part will be implemented more and more.

ATTENTION: for all warranty claims please contact directly our service dept.

By clicking on help video you will see a video tutorial on how to use the portal.

Back to catalogue Catalogue Login

Access to the catalogue with username and password

Username:

Password:

Login

Forgotten your password? [Click here.](#)

HELP/VIDEO

Components Engine 6

We hope you appreciate this new service which will allow our customers an easier access to documentation and spare parts supply.

We remain available for any further info you may need.



EN 17735:2022

* The WRAS Approved Product logo is a certification marks which is owned by WRAS Ltd. - WRAS Approved Type AA - air gap

The certification brands do not refer to all products. Our documentation includes certified and non-certified products.

The information required by the Article 33 (1) of Regulation (EC) 1907/2006 (REACH) and the related SCIP notifications are available on our website.

For more information, please contact the manufacturer.



KROMO ALI GROUP SRL
Via Mestre, 3
31033 Castelfranco Veneto (TV)
T: +39 0423 734580
E: kromo@kromo-ali.com

SERVICE:
T: +39 0423 734593
E: service@kromo-ali.com

www.kromo-ali.com

Edition 04.2026

an Ali Group Company



The Spirit of Excellence